

The Submersible Borehole Pump Range

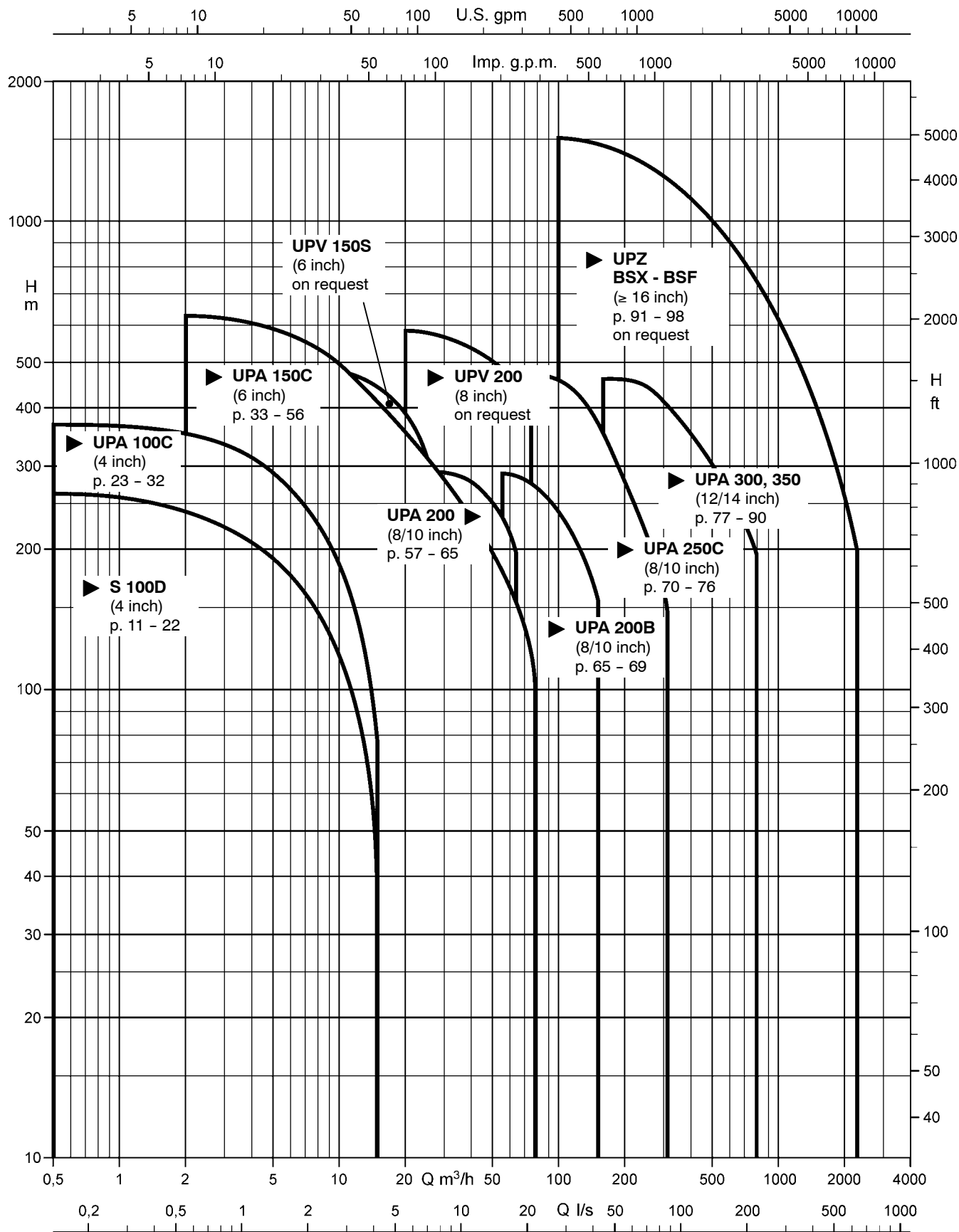

Applications

- Domestic and general water supply
- Irrigation and spray irrigation
- Lowering groundwater levels
- Fountains
- Pressure boosting
- Air-conditioning systems
- Fire protection
- Cooling water cycles

Operating Data

Capacity	Q up to 16 m ³ /h (4.4 l/s)
Head	H up to 300 m
Temperature of fluid handled	t up to +30 °C in continuous operation
Power	Pn up to 5.5 kW

Pump Type / Design

Pump:

Stainless steel and plastic multistage centrifugal pump.

- Additional bearing depending on the number of stages
- Pump sizes D1 and D2 with anti-blockage feature. This consists of a hexagonal polyurethane disc mounted to the back of the diffuser. A PE-HD ring fitted to the impeller front side sits close to the disc. The impeller hub is protected by a polyurethane ring. This design improves the starting torque of low-capacity pumps and has the effect that solid particles such as sand are propelled outside instead of clogging the pump.

Motor:

Submersible canned motor (Franklin), NEMA standard, 50 Hz

- For single-phase alternating current (type PSC) or three-phase current
- With short cable
- Connection to power supply mains by means of cable connector (accessories)
- D.o.l. starting, start-up frequency up to 20/h
- Type of enclosure IP 68
- Thermal class B

Designation

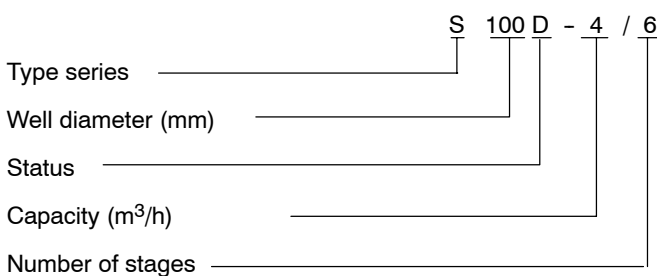

Recommended Accessories

UPA Control: Control box for motor and dry running protection by immersion electrodes.

Automatic control unit: in conjunction with the Controlmatic E or Cervomatic EDP control and monitoring units, which protect the pump against dry running, if the water level falls, S 100D can be used for automatic water supply

Certification

Quality management certified to ISO 9001

Submersible Borehole Pumps for Well Diameters of 100 mm (4 inch)



Available automation products:

- Automatic control unit

Product Features

- Pumps sizes D1 and D2 with anti-blockage feature
- Rust-proof
- Suitable for installation in narrow deep wells
- High efficiency
- Hermetically sealed motor
- Motor designed for maximum pump output
- Low noise level
- For vertical, angled or horizontal installation

Selection Chart (Ranges on Offer)

$n \approx 2900$ rpm

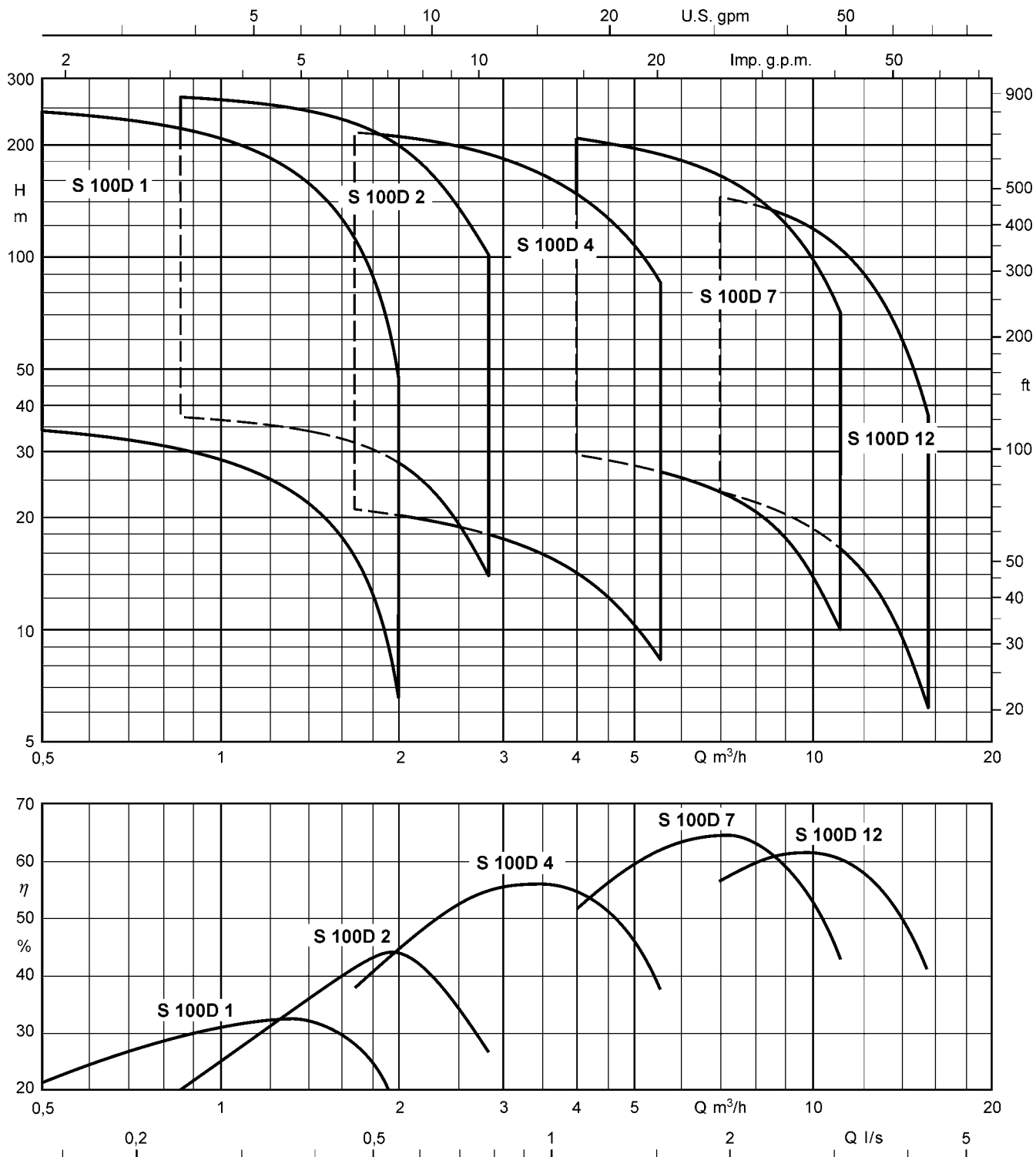

Note:

Up to a motor rating of $P_N = 2.2$ kW, all pump sizes can be supplied with either single-phase a.c. or three-phase current motors.

Materials

Component	C1
Pump ...	
Outer pump casing/ Suction casing / Valve housing	CrNi steel (1.4301)
Stage casing	CrNi steel (1.4301)
Stage casing (diffuser) / Impeller	glass fibre reinforced Noryl (PPO GF20V)
Shaft	Cr-steel (1.4021)
Bearing bush	Nitril NBR 80
Screws, bolts and nuts	CrNiMo-steel (A4-70)
Motor ...	
Shaft	CrNi steel (1.4305)
Bearing carrier	CrNi steel (1.4301)
Stator case	CrNi steel (1.4301)

Bearings / Lubrication

Plain bearings, lubricated by the fluid pumped or by the motor fill liquid. Depending on the number of stages, an additional intermediate bearing is provided in the pump.

The axial thrust is balanced by a thrust bearing in the motor. The hydraulic thrust is balanced by the pump's counter thrust bearing.

Direction of Rotation of the Pump

Clockwise rotation (viewed at the drive shaft end).

Pump End (Discharge Nozzle)

S 100D - 1, 2, 4 + 7: Internal thread G 1 1/4" (DN 32).

S 100D - 12: Internal thread G 2" (DN 50).

Installation

Vertical and, depending on the number of stages, also angled and horizontal installation.

Drive

Type canned motor in squirrel-cage design, 2 poles
 Connection NEMA standard
 Type of enclosure IP 68
 Frequency 50 Hz
 Type of current single-phase a.c. (1 ~) or three-phase (3 ~)
 Rated voltage U 220 ... 230 V (1~) and 380 ... 400 V (3~)
 Rated power P_N up to 2.2 kW for 1~ and up to 5.5 kW for 3~
 Voltage fluctuation up to ± 5 % acc. to VDE
 Frequency of starts up to 20/h
 Min. delay before restarting . 3 min

A starter for **single-phase a.c. motors** in PSC design (with integrated run capacitor and motor protection) is included in the scope of supply.

Connection to Power Supply

All DN 100 motors are factory-equipped as follows: 1 x 1.5 m flat cable, quality 4 x 1.5 mm² (3 phases + 1 earth conductor).

Exception: DN 100 motors with a rating of 5.5 kW, 3~, are equipped as follows: 2.5 m cable, quality 4 x 1.5 mm².

Connection of extension cable (any length) by means of a cable connector

Connected at the factory by means of a **standard cable connector (non-separable, shrink tube)**

Ident. No. 40 980 708
 For cable quality 4 x 1.5 mm² or 4 x 2.5 mm²
 Ident. No. 39 020 536
 For cable quality 4 x 4 mm²

Connected at the factory with **Franklin cable connector (separable, sealing compound)**

Ident. No. 90 049 385
 For cable quality 4 x 1.5 mm² up to 4 x 2.5 mm²

Starting Mode

Only **direct on line**.

Temperatures

The **S 100D** submersible borehole pump is designed for use in water with temperatures of up to t = + 30 °C.

Variants Available on Request

- Higher fluid temperatures
- Higher voltages up to 500 V
- Other frequencies

S 100D - 1 ...

for well diameters of 100 mm (4 inch)

Pumps with submersible motors for ...

- Temperature of fluid handled **up to + 30 °C**
- Current / Operating voltage **1~/230 V**
..... or **3~/400 V**
- Starting **direct**

Pump unit S 100D	Rated power (motor) P _N kW	Current intensity for ...		Installation ²⁾	Operation with control unit ³⁾
		1~ 230 V I _N ¹⁾ A	3~ 400 V I _N A		
1 / 7	0.37	3.4	1.3	v + h	x
1 / 9	0.37	3.4	1.3	v + h	x
1 / 12	0.55	3.4	1.3	v + h	x
1 / 14	0.55	4.3	1.7	v + h	x
1 / 16	0.55	4.3	1.7	v + h	x ³⁾
1 / 20	0.75	4.3	1.7	v + h	x ³⁾
1 / 25	1.10	5.7	2.2	v	x ³⁾
1 / 30	1.10	5.7	2.2	v	x ³⁾
1 / 35	1.50	8.6	3.2	v	x ³⁾
1 / 40	1.50	8.6	3.2	v	x ³⁾
1 / 50	2.20	10.6	4.0	v	x ³⁾⁴⁾

1) Capacitor run motors (PSC motors) with starter.
 2) v = vertical and h = inclined / horizontal.
 3) Always check and make sure that the operating pressure of Controlmatic / Cervomatic units is not exceeded.
 4) 3~ only

Note : Use a cooling shroud for horizontal installation.

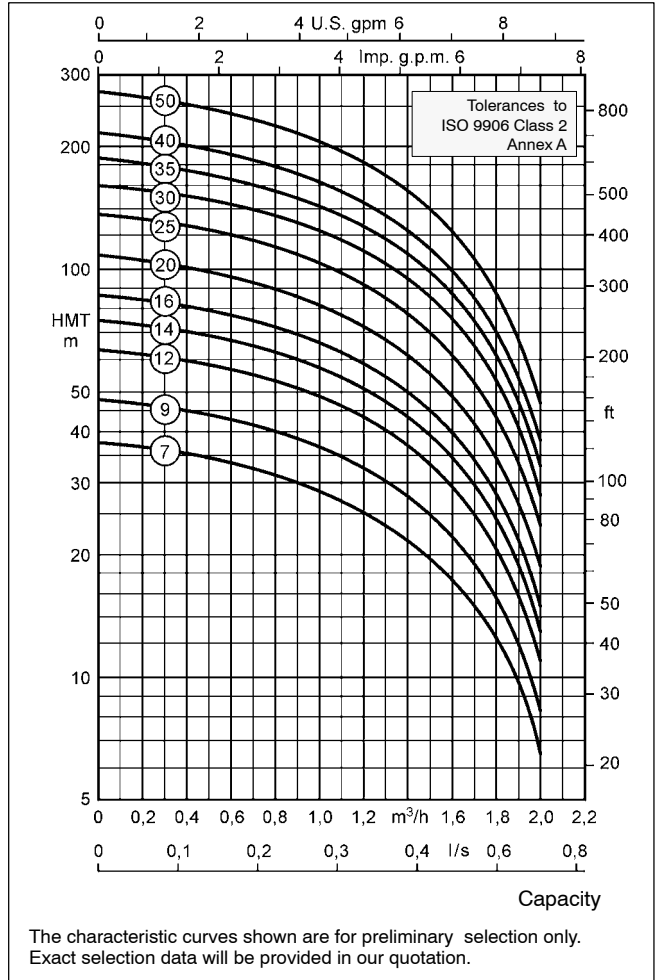

Dimensions / Weights / Ident. Numbers / Horizontal Installation

Pump unit S 100D	1~/ 230 V				3~/ 400 V				C
	L _A ≈ mm	m _A ≈ kg	Ident No.	A ≈ mm	L _A ≈ mm	m _A ≈ kg	Ident No.	A ≈ mm	
1 / 7	575	11.5	39 022 528	371	555	10.7	39 022 565	362	G 1 1/4"
1 / 9	625	11.7	39 022 529	425	605	10.9	39 022 566	416	
1 / 12	720	13.4	39 022 530	508	700	12.2	39 022 567	492	
1 / 14	795	13.6	39 022 531	552	755	12.4	39 022 568	537	
1 / 16	810	13.8	39 022 532	597	780	12.6	39 022 569	582	
1 / 20	925	14.3	39 022 533	687	870	13.1	39 022 570	672	
1 / 25	1100	16.3	39 022 534	----	1045	14.9	39 022 571	----	
1 / 30	1210	16.8	39 022 535	----	1150	15.4	39 022 572	----	
1 / 35	1395	20.0	39 022 536	----	1310	17.4	39 022 573	----	
1 / 40	1505	20.6	39 022 537	----	1450	18.0	39 022 574	----	
1 / 50	1805	22.7	39 022 538	----	1705	20.3	39 022 575	----	

For information on cooling shroud refer to page 20.

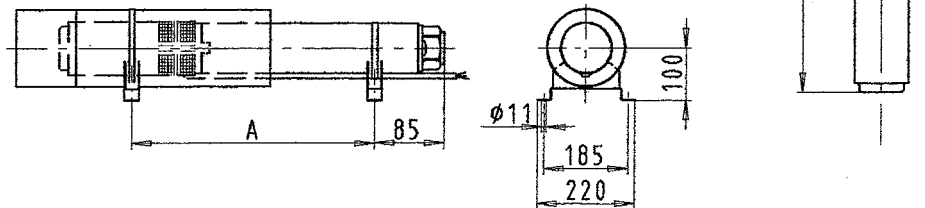

Accessories: UPA Control for dry running protection using 1 or 3 immersion electrodes, see page 21.

S 100D - 2 ...

for well diameters of 100 mm (4 inch)

Pumps with submersible motors for ...

- Temperature of fluid handled **up to + 30 °C**
- Current / Operation voltage **1~/230 V**
- or. **3~/400 V**
- Starting **direct**

Pump unit S 100D	Rated power (motor) P_N kW	Current intensity for ...		Installation ²⁾	Operation with control unit ³⁾
		1~ 230 V I_N¹⁾ A	3~ 400 V I_N A		
2 / 7	0.37	3.4	1.3	v + h	x
2 / 11	0.55	4.3	1.7	v + h	x
2 / 15	0.75	5.6	2.2	v + h	x
2 / 18	1.1	8.6	3.2	v + h	x ³⁾
2 / 20	1.1	8.6	3.2	v + h	x ³⁾
2 / 22	1.1	8.6	3.2	v + h	x ³⁾
2 / 27	1.5	10.6	4.0	v + h	x ³⁾
2 / 30	1.5	10.6	4.0	v	x ³⁾
2 / 33	2.2	15.5	5.9	v	x ³⁾
2 / 38	2.2	15.5	5.9	v	x ³⁾
2 / 44	2.2	15.5	5.9	v	x ³⁾
2 / 50	3.0	-	7.8	v	x ³⁾⁴⁾

1) Capacitor run motors (PSC motors) with starter.
 2) v = vertical and h = inclined / horizontal.
 3) Always check and make sure that the operating pressure of Controlmatic / Cervomatic units is not exceeded.
 4) 3~ only

Note : Use a cooling shroud for horizontal installation.

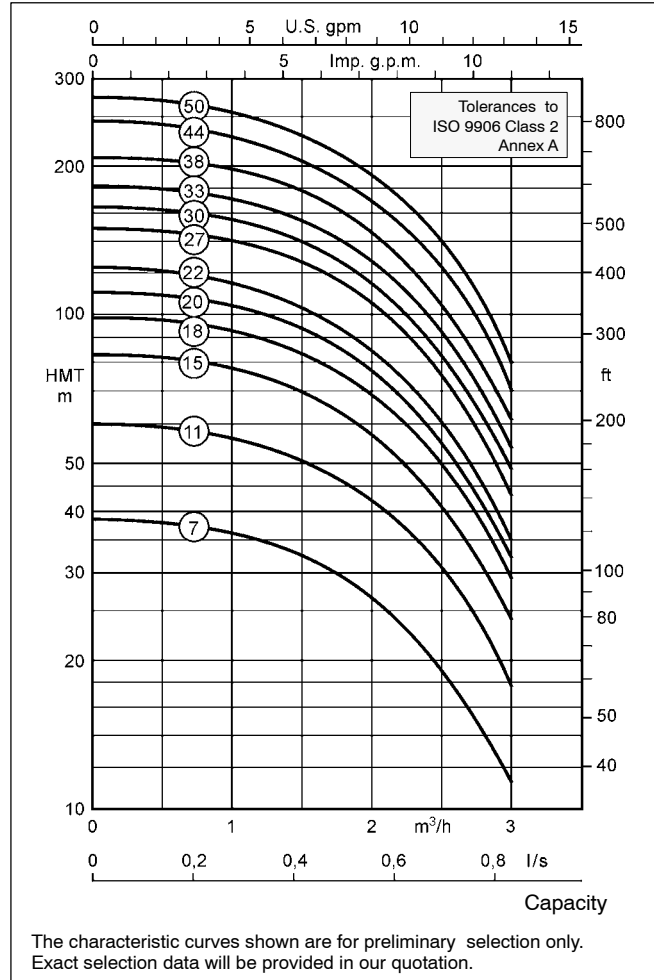

Dimensions / Weights / Ident. Numbers / Horizontal Installation

Pump unit S 100D	1~/230 V				3~/400 V				C
	L _A ≈ mm	m _A ≈ kg	Ident No.	A ≈ mm	L _A ≈ mm	m _A ≈ kg	Ident No.	A ≈ mm	
2 / 7	570	11.3	39 022 539	371	550	10.5	39 022 576	362	G 1 1/4"
2 / 11	695	13.0	39 022 540	484	665	11.8	39 022 577	470	
2 / 15	815	14.8	39 022 541	589	790	13.4	39 022 578	574	
2 / 18	940	17.7	39 022 542	684	880	15.1	39 022 579	655	
2 / 20	985	17.8	39 022 543	729	925	15.2	39 022 580	701	
2 / 22	1030	18.0	39 022 544	775	970	15.4	39 022 581	746	
2 / 27	1175	19.5	39 022 545	901	1120	17.1	39 022 582	873	
2 / 30	1235	19.9	39 022 546	----	1180	17.5	39 022 583	----	
2 / 33	1425	23.6	39 022 547	----	1325	19.0	39 022 584	----	
2 / 38	1535	24.1	39 022 548	----	1435	19.5	39 022 585	----	
2 / 44	1670	24.6	39 022 549	----	1570	20.0	39 022 586	----	
2 / 50	----	----	----	----	1770	23.6	39 022 587	----	

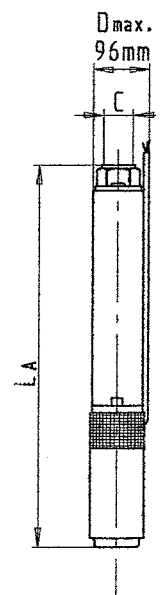

For information on cooling shroud refer to page 20.

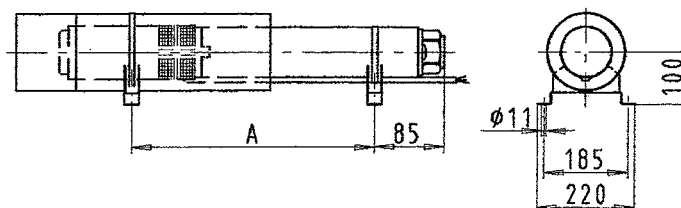

Accessories: UPA Control for dry running protection using 1 or 3 immersion electrodes, see page 21.

S 100D - 4 ...

for well diameters of 100 mm (4 inch)

Pumps with submersible motors for ...

- Temperature of fluid handled **up to + 30 °C**
- Current / Operating voltage **1~/230 V**
..... or **3~/400 V**
- Starting **direct**

Pump unit S 100D	Rated power (motor) P_N kW	Current intensity for ...		Instal- lation ²⁾	Opera- tion with control unit ³⁾
		1~ 230 V I_N¹⁾ A	3~ 400 V I_N A		
4 / 3	0.37	3.4	1.3	v + h	x
4 / 6	0.55	4.3	1.7	v + h	x
4 / 8	0.75	5.7	2.2	v + h	x
4 / 11	1.10	8.6	3.2	v + h	x
4 / 16	1.50	10.6	4.0	v + h	x ³⁾⁴⁾
4 / 21	2.20	15.5	5.9	v + h	x ³⁾⁴⁾
4 / 24	2.20	15.5	5.9	v	x ³⁾⁴⁾
4 / 33	3.00	---	7.8	v	x ³⁾⁴⁾
4 / 40	3.70	---	9.1	v	x ³⁾⁴⁾

- 1) Capacitor run motors (PSC motors) with starter.
- 2) v = vertical and h = inclined / horizontal.
- 3) Always check and make sure that the operating pressure of Controlmatic / Cervomatic units is not exceeded.
- 4) 3~ only

Note : Use a cooling shroud for horizontal installation.

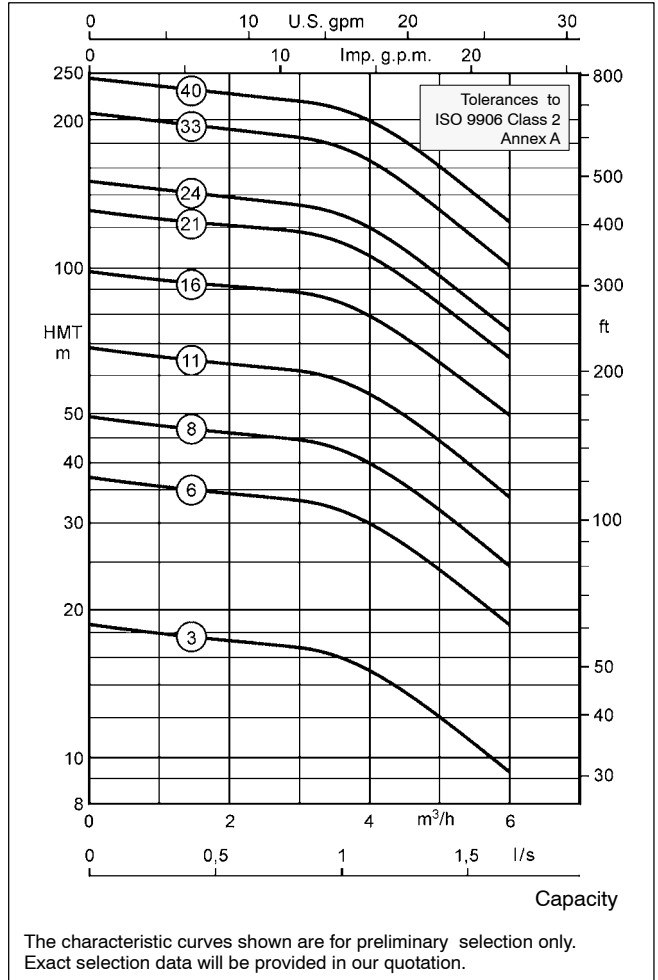

The characteristic curves shown are for preliminary selection only. Exact selection data will be provided in our quotation.

Dimensions / Weights / Ident. Numbers / Horizontal Installation

Pump unit S 100D	1~ / 230 V				3~ / 400 V				C
	L _A ≈ mm	m _A ≈ kg	Ident No.	A ≈ mm	L _A ≈ mm	m _A ≈ kg	Ident No.	A ≈ mm	
4 / 3	505	11.5	39 022 550	333	485	10.7	39 022 588	324	G 1 1/4"
4 / 6	610	13.4	39 022 551	399	580	12.2	39 022 589	384	
4 / 8	690	15.1	39 022 552	489	665	13.7	39 022 590	475	
4 / 11	820	18.2	39 022 553	594	760	15.6	39 022 591	566	
4 / 16	975	20.1	39 022 554	734	920	17.7	39 022 592	706	
4 / 21	1180	24.8	39 022 555	900	1080	20.2	39 022 593	847	
4 / 24	1255	25.3	39 022 556	---	1155	20.7	39 022 594	---	
4 / 33	---	---	---	---	1595	25.5	39 022 595	---	
4 / 40	---	---	---	---	1805	33.0	39 022 596	---	

For information on cooling shroud refer to page 20.

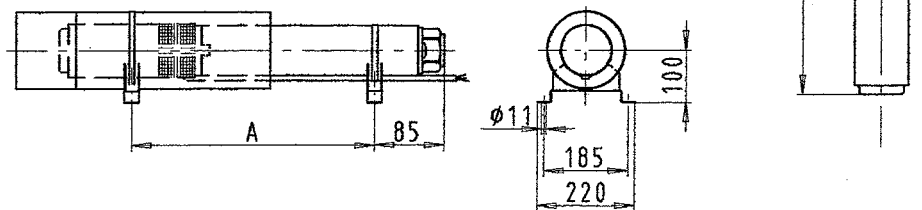

Accessories: UPA Control for dry running protection using 1 or 3 immersion electrodes, see page 21.

S 100D - 7 ...

for well diameters of 100 mm (4 inch)

Pumps with submersible motors for ...

- Temperature of fluid handled up to + 30 °C
- Current / Operating voltage 1~/230 V
..... or 3~/400 V
- Starting direct

Pump unit S 100D	Rated power (motor) P _N kW	Current intensity for ...		Installation ²⁾	Operation with control unit ³⁾
		1~ 230 V I _N ¹⁾ A	3~ 400 V I _N A		
7 / 4	0.75	5.7	2.2	v + h	x
7 / 6	1.10	8.6	3.2	v + h	x
7 / 8	1.50	10.6	4.0	v + h	x ⁴⁾
7 / 11	2.20	15.5	5.9	v + h	x ⁴⁾
7 / 13	2.20	15.5	5.9	v + h	x ⁴⁾
7 / 18	3.00	---	7.8	v + h	x ³⁾⁴⁾
7 / 23	3.70	---	9.1	v	x ³⁾⁴⁾
7 / 28	5.50	---	13.7	v	x ³⁾⁴⁾
7 / 33	5.50	---	13.7	v	x ³⁾⁴⁾

1) Capacitor run motors (PSC motors) with starter.
 2) v = vertical and h = inclined / horizontal.
 3) Always check and make sure that the operating pressure of Controlmatic / Cervomatic units is not exceeded.
 4) 3~ only

Note : Use a cooling shroud for horizontal installation.

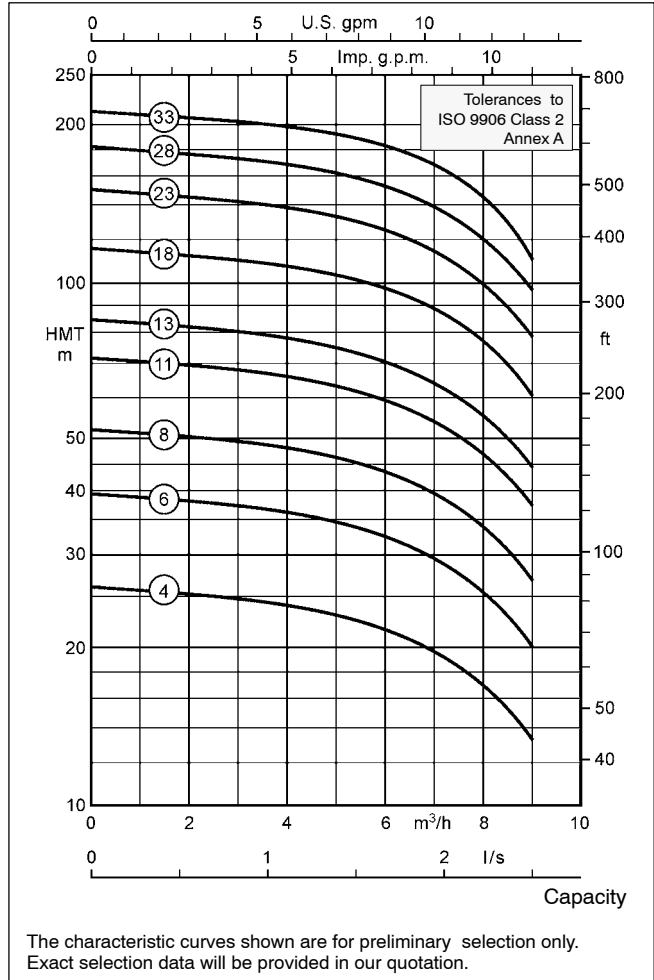

Dimensions / Weights / Ident. Numbers / Horizontal Installation

Pump unit S 100D	1~ / 230 V				3~ / 400 V				C
	L _A ≈ mm	m _A ≈ kg	Ident No.	A ≈ mm	L _A ≈ mm	m _A ≈ kg	Ident No.	A ≈ mm	
7 / 4	611	14.6	39 022 557	421	586	13.2	39 022 597	407	G 1 1/4"
7 / 6	736	17.7	39 022 558	517	676	15.1	39 022 598	489	
7 / 8	831	19.1	39 022 559	599	776	16.7	39 022 599	571	
7 / 11	1011	23.1	39 022 560	740	911	18.5	39 022 600	687	
7 / 13	1076	23.6	39 022 561	808	976	19.0	39 022 601	755	
7 / 18	----	----	----	----	1211	23.1	39 022 602	958	
7 / 23	----	----	----	----	1516	30.8	39 022 603	----	
7 / 28	----	----	----	----	1881	38.3	39 022 604	----	
7 / 33	----	----	----	----	2051	39.4	39 022 605	----	

For information on cooling shroud refer to page 20.

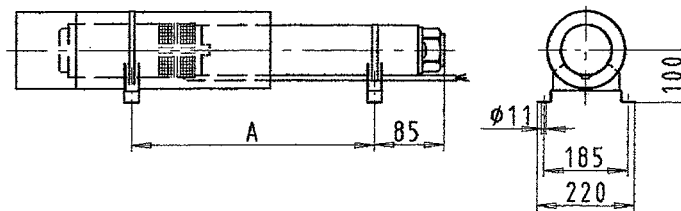
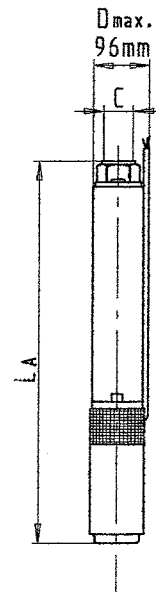

Accessories: UPA Control for dry running protection using 1 or 3 immersion electrodes, see page 21.

S 100D - 12 ...

for well diameters for 100 mm (4 inch)

Pumps with submersible motors for ...

- Temperature of fluid handled **up to + 30 °C**
- Current / Operation voltage **1~/230 V**
..... or **3~/400 V**
- Starting **direct**

Pump unit S 100D	Rated power (motor) P_N kW	Current intensity for ...		Installation ²⁾	Operation with control unit ³⁾
		1~ 230 V I_N¹⁾ A	3~ 400 V I_N A		
12 / 4	1.1	8.6	3.2	v + h	x
12 / 6	1.5	10.6	4.0	v + h	x
12 / 10	2.2	15.5	5.9	v + h	x
12 / 13	3.0	---	7.8	v	x ⁴⁾
12 / 17	3.7	---	9.1	v	x ³⁾⁴⁾
12 / 21	5.5	---	13.7	v	---
12 / 25	5.5	---	13.7	v	---

¹⁾ Capacitor run motors (PSC motors) with starter.
²⁾ v = vertical and h = inclined / horizontal.
³⁾ Always check and make sure that the operating pressure of Controlmatic / Cervomatic units is not exceeded.
⁴⁾ 3~ only

Note : Use a cooling shroud for horizontal installation.

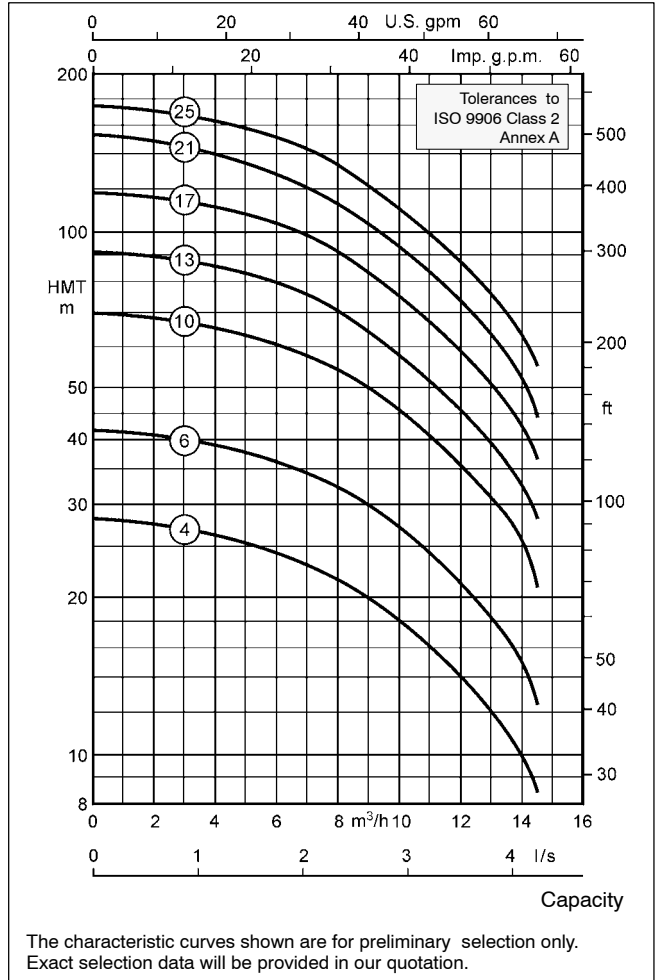

The characteristic curves shown are for preliminary selection only. Exact selection data will be provided in our quotation.

Dimensions / Weights / Ident. Numbers / Horizontal Installation

Pump unit S 100D	1~ / 230 V				3~ / 400 V				C
	L _A ≈ mm	m _A ≈ kg	Ident No.	A ≈ mm	L _A ≈ mm	m _A ≈ kg	Ident No.	A ≈ mm	
12 / 4	865	17.3	39 022 562	613	805	14.7	39 022 606	585	G 2"
12 / 6	1000	19.3	39 022 563	739	945	16.9	39 022 607	707	
12 / 10	1295	24.6	39 022 564	991	1195	20.0	39 022 608	938	
12 / 13	---	---	---	---	1425	24.2	39 022 609	---	
12 / 17	---	---	---	---	1815	32.2	39 022 610	---	
12 / 21	---	---	---	---	2185	40.2	39 022 611	---	
12 / 25	---	---	---	---	2400	42.0	39 022 612	---	

For information on cooling shroud refer to page 20.

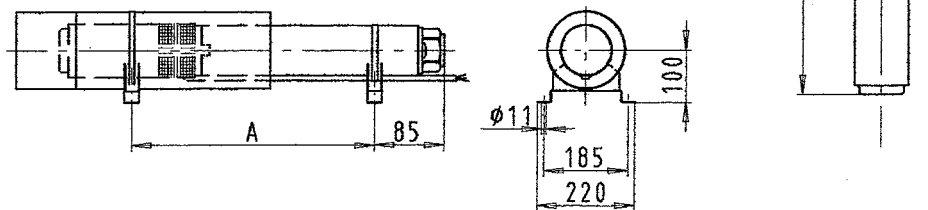

Accessories: UPA Control for dry running protection using 1 or 3 immersion electrodes, see page 21.

Applications

- Domestic and general water supply
- Irrigation and spray irrigation
- Lowering ground water levels
- Fountains
- Pressure boosting
- Air-conditioning systems
- Fire protection
- Cooling water cycles

Maximum permissible amount of suspended sand: 50 g/m³

Operating Data

Capacity	Q	up to 15 m ³ /h (250 l/min)
Head	H	up to 400 m
Temperature of fluid handled	t	30 °C
Motor ratings	P _N	up to 7.5 kW

Design

Multistage centrifugal pump with components made of stainless steel and additional bearing for each stage. The stage casings are connected by means of tie bolts on radial pumps, and by means of studs on mixed-flow pumps.

Submersible canned motor: Franklin Electric pre-filled motors, corrosion free, NEMA shaft end, 50 Hz

- Single-phase and three-phase motor type Super Stainless
- With separate lead
- Direct starting, max starts per hour: 20
- Type of enclosure: IP 68
- Insulation: Class B

Designation (Example)

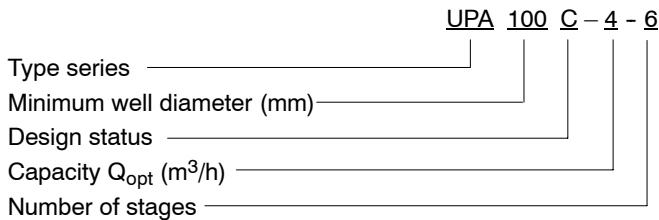

Certification

Quality management certified to ISO 9001

**Submersible Borehole Pumps
for Well Diameters of
100 mm (4 inches)**

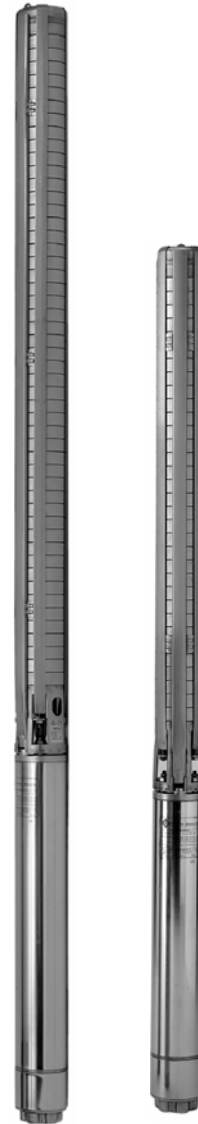

Product Features

- Very sturdy design
- All components made of stainless steel
- Suitable for installation in narrow deep wells
- High efficiency
- Totally enclosed motor
- Motor designed for maximum pump output
- Low noise level
- For vertical or horizontal installation
- Check valve protected against blocking
- Pre-filled motor; no risk of contamination of the pumped water

Selection Chart (Ranges on offer)

n ≈ 2900 rpm

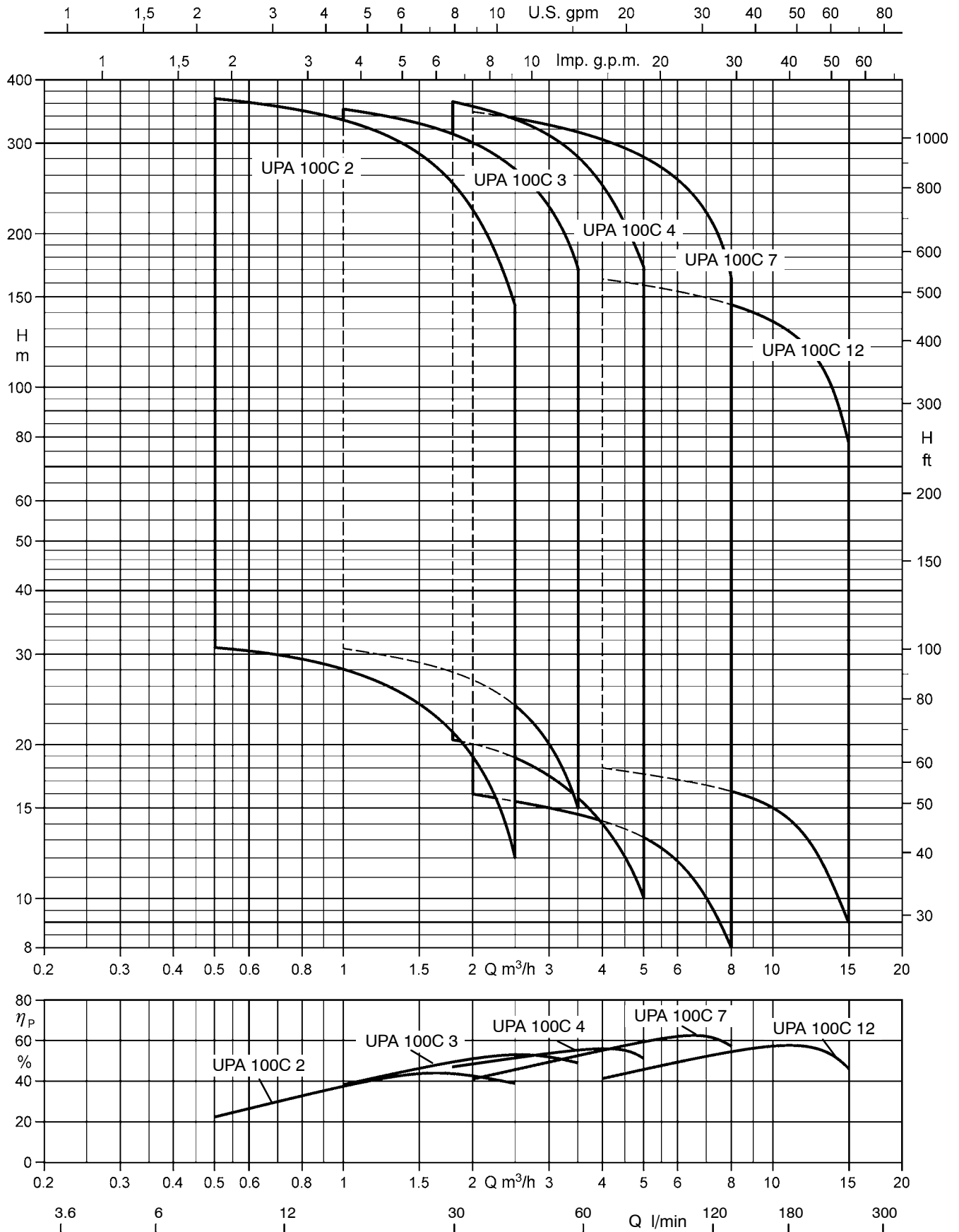

UPA 100C 2 - ...

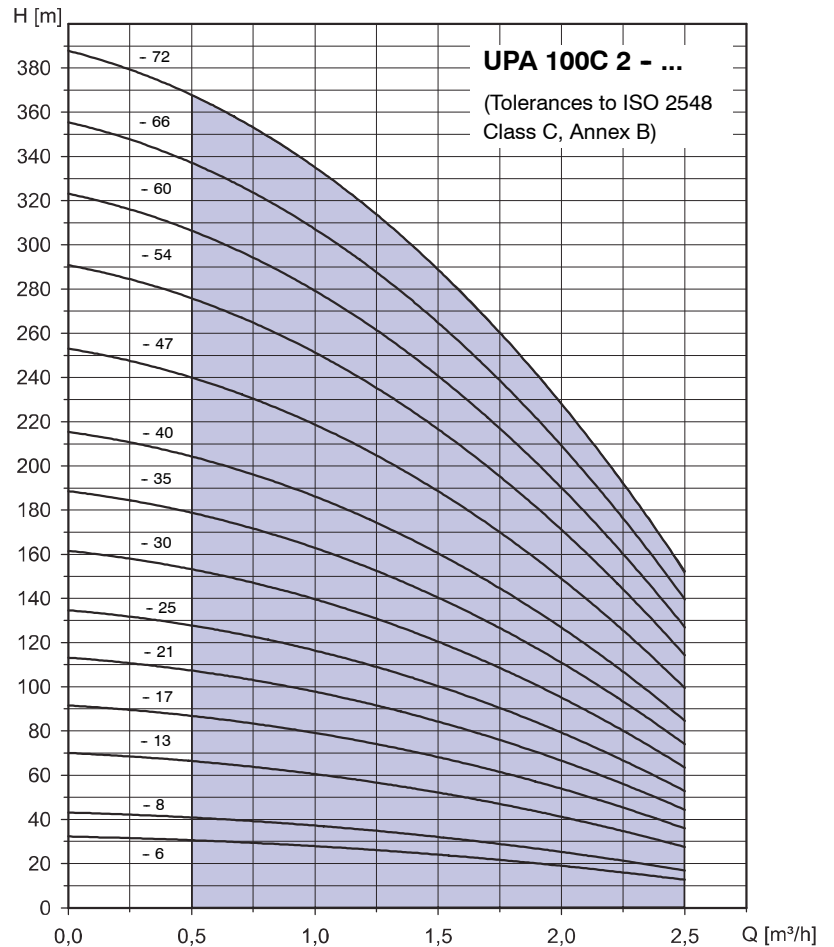
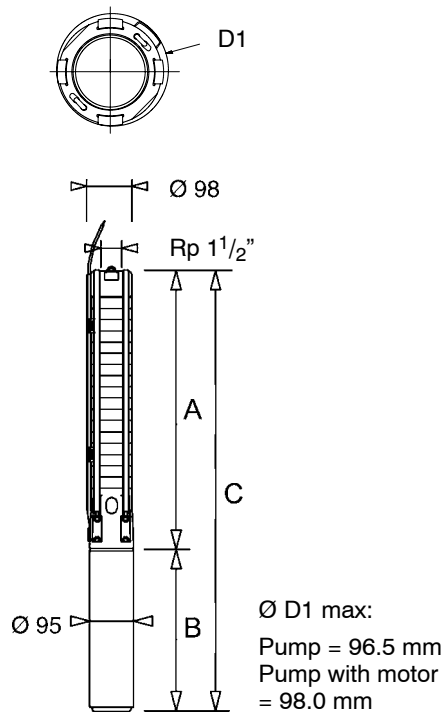

Pump set UPA 100C 2 - ..	Rated power (Motor) P _N kW	Rated power (Motor) P _N hp	Rated current for	
			1~ 220 V I _N ¹⁾ A	3~ 400 V I _N A
6	0.37	0.5	3.2	0.9
8	0.37	0.5	3.6	1.1
13	0.55	0.75	5.7	1.5
17	0.75	1	6.9	2.0
21	1.1	1.5	8.0	2.8
25	1.1	1.5	8.9	3.0
30	1.5	2	9.5	3.3
35	1.5	2	11.1	3.8
40	2.2	3	12.1	5.1
47	2.2	3	14.5	5.4
54	2.2	3	15.9	5.6
60	3.0	4	-	6.8
66	3.0	4	-	7.2
72	3.0	4	-	7.5

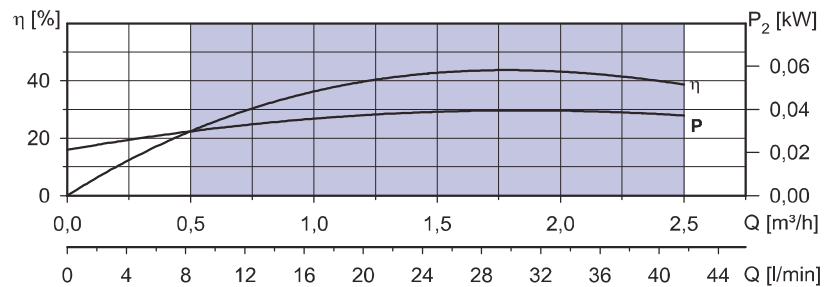

Operating range: 0.5 - 2.5 m³/h
 Q_{min} = 0.5 m³/h
 Q_{max} = End of characteristic curve

1) Capacitor run motors (PSC motors) with starter.

The characteristic curves shown are for preliminary selection only.
 Exact selection data will be provided in our quotation.

Dimensions / Weights / Ident. Numbers

Pump set UPA 100C 2 - ..	1~ / 220 V				3~ / 400 V			m _A ≈ kg
	A ≈ mm	B ≈ mm	C ≈ mm	Ident. No.	B ≈ mm	C ≈ mm	Ident. No.	
6	349	242	591	90 065 300	223	572	90 065 387	11.1
8	397	242	639	90 065 301	223	620	90 065 388	11.7
13	517	271	788	90 065 302	242	759	90 065 389	14.3
17	623	299	922	90 065 303	271	894	90 065 390	17.0
21	711	327	1038	90 065 304	299	1010	90 065 391	19.5
25	807	327	1134	90 065 305	299	1106	90 065 392	20.8
30	928	356	1284	90 065 306	327	1255	90 065 393	23.7
35	1048	356	1404	90 065 307	327	1375	90 065 394	25.4
40	1169	460	1629	90 065 308	356	1525	90 065 395	28.1
47	1338	460	1798	90 065 309	356	1694	90 065 396	29.5
54	1506	460	1966	90 065 310	356	1862	90 065 397	32.6
60	1651	-	-	-	423	2074	90 065 398	37.0
66	1796	-	-	-	423	2219	90 065 399	38.9
72	1941	-	-	-	423	2364	90 065 400	40.9

For horizontal installation, a device guiding the flow along the motor (cooling shroud, flow inducer sleeve, etc.) will be required.

Accessories: UPA Control for dry running protection see page 32.

UPA 100C 3 - ...

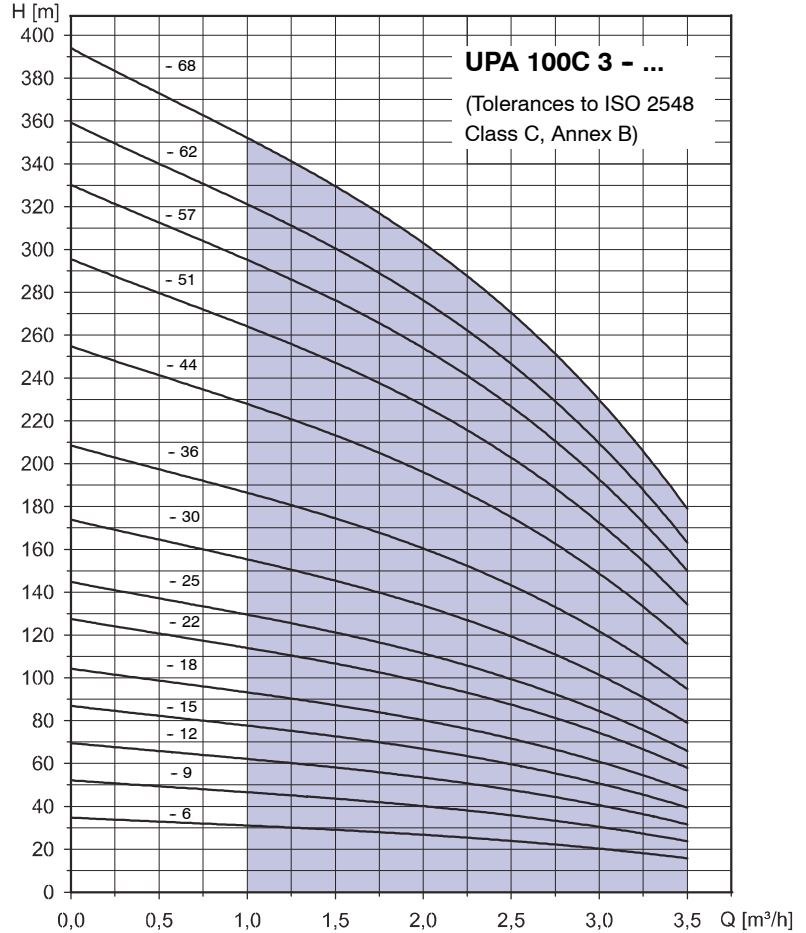
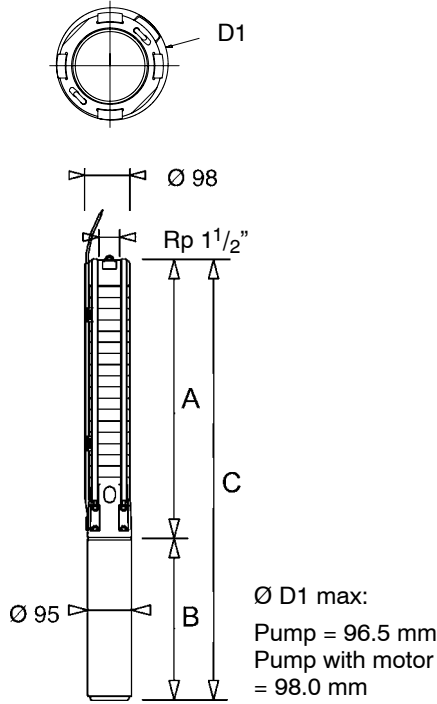

Pump set UPA 100C 3 -...	Rated power (Motor) P_N kW	Rated power (Motor) P_N hp	Rated current for	
			1~ 220 V I_N¹⁾ A	3~ 400 V I_N A
6	0.37	0.5	3.6	1.1
9	0.55	0.75	5.7	1.5
12	0.75	1.0	6.9	2.0
15	1.1	1.5	8.7	2.9
18	1.1	1.5	8.9	3.0
22	1.5	2.0	9.8	3.6
25	1.5	2.0	11.1	3.8
30	2.2	3.0	12.5	5.2
36	2.2	3.0	15.9	5.6
44	3.0	4.00	-	7.0
51	3.0	4.0	-	7.2
57	3.7	5.0	-	8.8
62	3.7	5.0	-	9.1
68	4.0	5.5	-	10.00

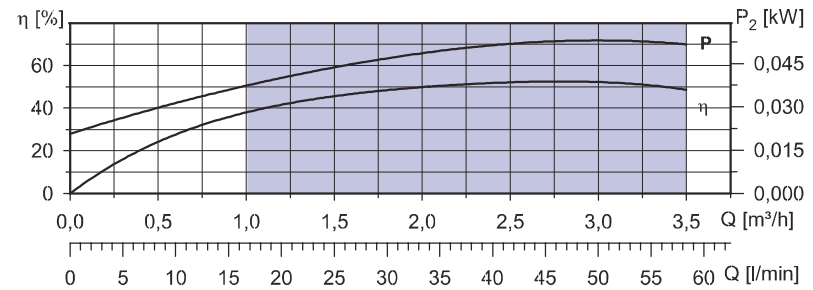

Operating range: 1.0 - 3.5 m³/h
 Q_{min} = 1.0 m³/h
 Q_{max} = End of characteristic curve

1) Capacitor run motors (PSC motors) with starter.

The characteristic curves shown are for preliminary selection only.
 Exact selection data will be provided in our quotation.

Dimensions / Weights / Ident. Numbers

Pump set UPA 100C 3 -...	1~ / 220 V				3~ / 400 V			m _A = kg
	A ≈ mm	B ≈ mm	C ≈ mm	Ident. No.	B ≈ mm	C ≈ mm	Ident. No.	
6	349	242	591	90 065 311	223	572	90 065 401	11.1
9	421	271	692	90 065 312	242	663	90 065 402	13.1
12	493	299	792	90 065 313	271	764	90 065 403	15.4
15	566	327	883	90 065 314	299	865	90 065 404	17.1
18	638	327	965	90 065 315	299	937	90 065 405	18.5
22	734	356	1090	90 065 316	327	1061	90 065 406	21.1
25	807	356	1163	90 065 317	327	1134	90 065 407	22.1
30	928	460	1388	90 065 318	356	1284	90 065 408	25.1
36	1072	460	1532	90 065 319	356	1428	90 065 409	27.2
44	1265	-	-	-	423	1688	90 065 410	32.3
51	1434	-	-	-	423	1857	90 065 411	34.7
57	1579	-	-	-	545	2124	90 065 412	41.5
62	1699	-	-	-	545	2244	90 065 413	43.2
68	1844	-	-	-	583	2427	90 065 414	48.3

For horizontal installation, a device guiding the flow along the motor (cooling shroud, flow inducer sleeve, etc.) will be required.

Accessories: UPA Control for dry running protection see page 32.

UPA 100C 4 - ...

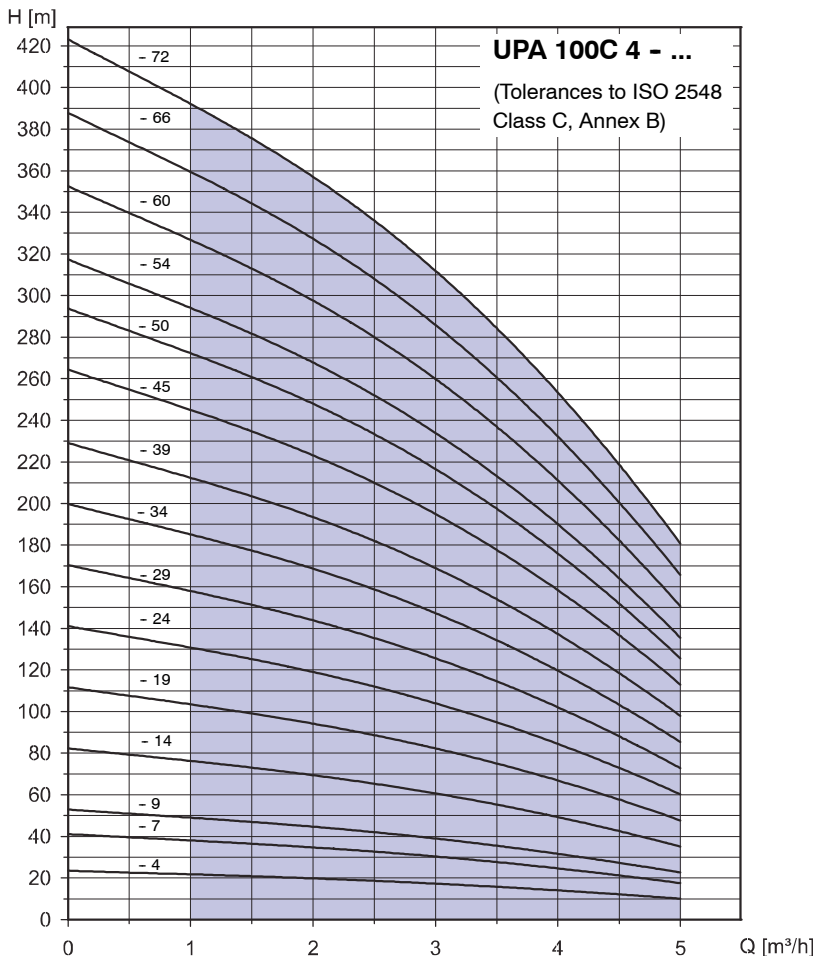
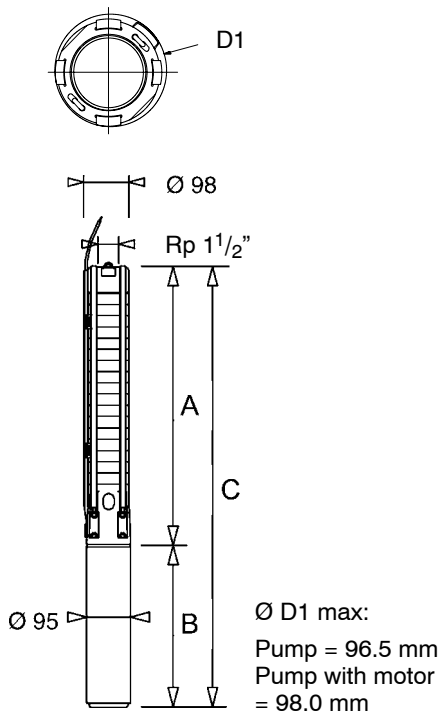

Pump set UPA 100C 4 - ...	Rated power (Motor) P_N kW	Rated power (Motor) P_N hp	Rated current for	
			1~ 220 V I_N¹⁾ A	3~ 400 V I_N A
4	0.37	0.5	3.6	1.1
7	0.55	0.75	5.7	1.5
9	0.75	1.0	6.9	2.0
14	1.1	1.5	8.9	3.0
19	1.5	2.0	11.1	3.8
24	2.2	3.0	12.8	5.3
29	2.2	3.0	15.9	5.6
34	3.0	4.0	-	7.0
39	3.0	4.0	-	7.2
45	3.7	5.0	-	8.8
50	3.7	5.0	-	9.1
54	4.0	5.5	-	10.0
60	5.5	7.5	-	11.5
66	5.5	7.5	-	12.5
72	5.5	7.5	-	13.2

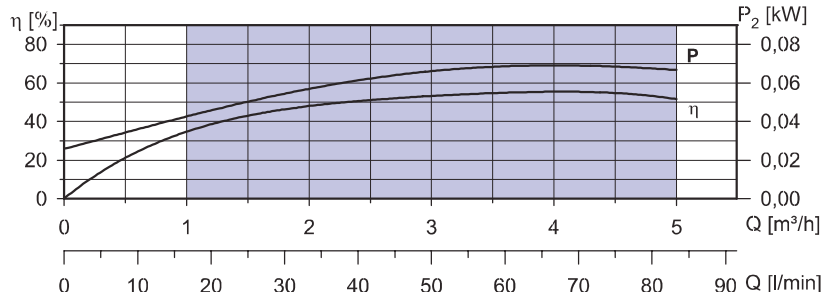

Operating range: 1.0 - 5.0 m³/h
 Q_{min} = 1.0 m³/h
 Q_{max} = End of characteristic curve

The characteristic curves shown are for preliminary selection only.
 Exact selection data will be provided in our quotation.

¹⁾ Capacitor run motors (PSC motors) with starter.

Dimensions / Weights / Ident. Numbers

Pump set UPA 100C 4 - ...	1~ / 220 V				3~ / 400 V			m _A ≈ kg
	A ≈ mm	B ≈ mm	C ≈ mm	Ident. No.	B ≈ mm	C ≈ mm	Ident. No.	
4	300	242	542	90 065 320	223	523	90 065 415	10.5
7	373	271	644	90 065 321	242	615	90 065 416	12.5
9	421	299	720	90 065 322	271	692	90 065 417	14.5
14	542	327	869	90 065 323	299	841	90 065 418	17.4
19	662	356	1018	90 065 324	327	989	90 065 419	20.4
24	783	460	1243	90 065 325	356	1139	90 065 420	23.5
29	903	460	1363	90 065 326	356	1259	90 065 421	25.2
34	1024	-	-	-	423	1447	90 065 422	29.4
39	1145	-	-	-	423	1568	90 065 423	31.1
45	1289	-	-	-	545	1834	90 065 424	38.0
50	1410	-	-	-	545	1955	90 065 425	39.7
54	1506	-	-	-	583	2089	90 065 426	44.3
60	1651	-	-	-	698	2349	90 065 427	51.6
66	1796	-	-	-	698	2494	90 065 428	53.7
72	1941	-	-	-	698	2639	90 065 429	55.7

For horizontal installation, a device guiding the flow along the motor (cooling shroud, flow inducer sleeve, etc.) will be required.

Accessories: UPA Control for dry running protection see page 32.

UPA 100C 7 - ...

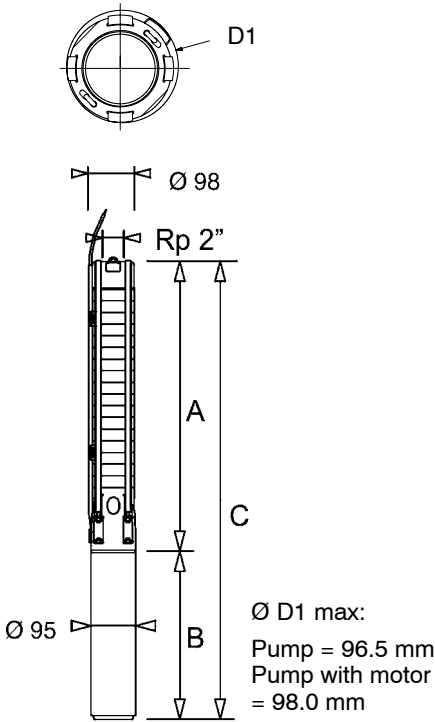

Pump set UPA 100C 7 -..	Rated power (Motor) P_N kW	Rated power (Motor) P_N hp	Rated current for	
			1~ 220 V I_N¹⁾ A	3~ 400 V I_N A
3	0.37	0.5	3.6	1.1
4	0.55	0.75	5.7	1.5
6	0.75	1.0	6.9	2.0
9	1.1	1.5	8.9	3.0
13	1.5	2.0	11.1	3.8
16	2.2	3.0	12.8	5.2
19	2.2	3.0	15.9	5.6
23	3.0	4.0	-	6.6
26	3.0	4.0	-	7.2
29	3.7	5.0	-	8.3
32	3.7	5.0	-	9.1
34	4.0	5.5	-	10.0
39	5.5	7.5	-	11.5
44	5.5	7.5	-	12.5
49	5.5	7.5	-	13.2
54	7.5	10.0	-	17.5
59	7.5	10.0	-	18.3
64	7.5	10.0	-	19.1

¹⁾ Capacitor run motors (PSC motors) with starter.

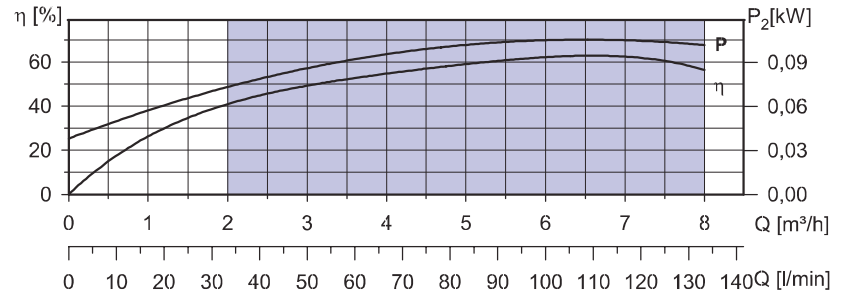
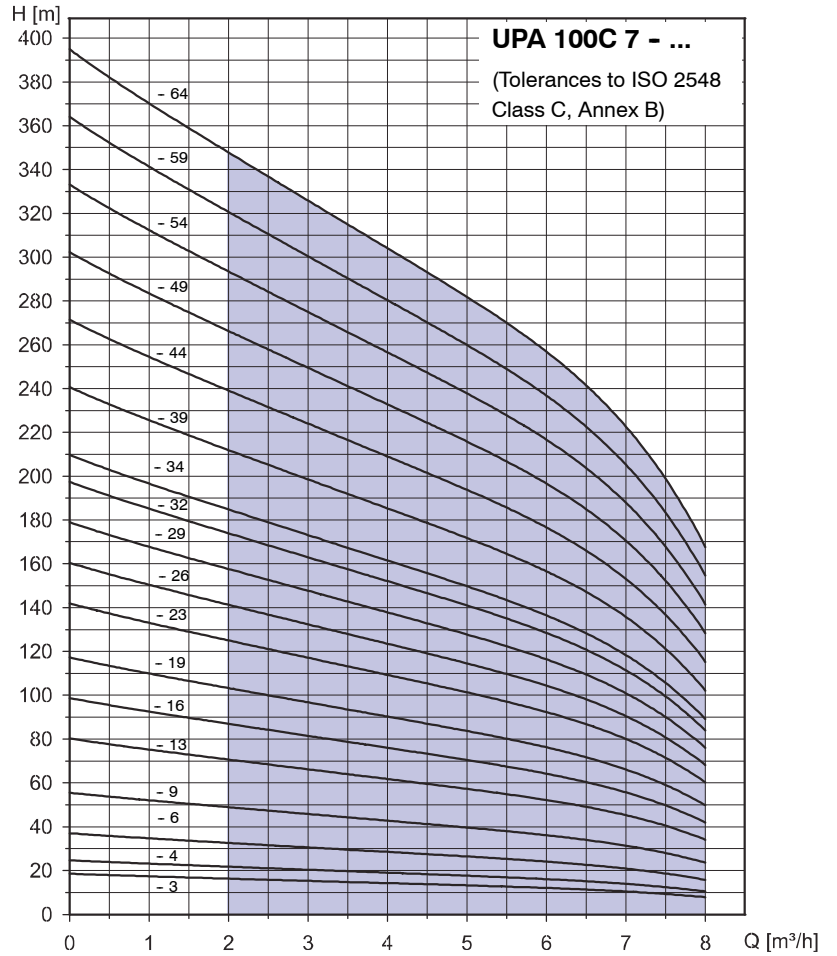

Operating range: 2.0 - 8.0 m³/h
Q_{min} = 2.0 m³/h
Q_{max} = End of characteristic curve

The characteristic curves shown are for preliminary selection only. Exact selection data will be provided in our quotation.

Dimensions / Weights / Ident. Numbers

Pump set UPA 100C 7 -..	1~ / 220 V				3~ / 400 V			m _A = kg
	A ≈ mm	B ≈ mm	C ≈ mm	Ident. No.	B ≈ mm	C ≈ mm	Ident. No.	
3	276	242	519	90 065 327	223	500	90 065 430	10.2
4	300	271	571	90 065 328	242	542	90 065 431	11.5
6	349	299	648	90 065 329	271	620	90 065 432	13.5
9	421	327	748	90 065 330	299	720	90 065 433	15.8
13	517	356	873	90 065 331	327	844	90 065 434	18.5
16	590	460	1050	90 065 332	356	946	90 065 435	21.0
19	662	460	1122	90 065 333	356	1118	90 065 436	22.0
23	759	-	-	-	423	1182	90 065 437	25.9
26	831	-	-	-	423	1254	90 065 438	27.0
29	903	-	-	-	545	1448	90 065 439	33.0
32	976	-	-	-	545	1521	90 065 440	34.0
34	1024	-	-	-	583	1607	90 065 441	37.9
39	1145	-	-	-	698	1843	90 065 442	45.0
44	1266	-	-	-	698	1964	90 065 443	46.8
49	1386	-	-	-	698	2084	90 065 444	48.6
54	1506	-	-	-	774	2280	90 065 445	53.9
59	1628	-	-	-	774	2402	90 065 446	55.7
64	1748	-	-	-	774	2522	90 065 447	59.5

For horizontal installation, a device guiding the flow along the motor (cooling shroud, flow inducer sleeve, etc.) will be required.
Accessories: UPA Control for dry running protection see page 32.

UPA 100C 12 - ...

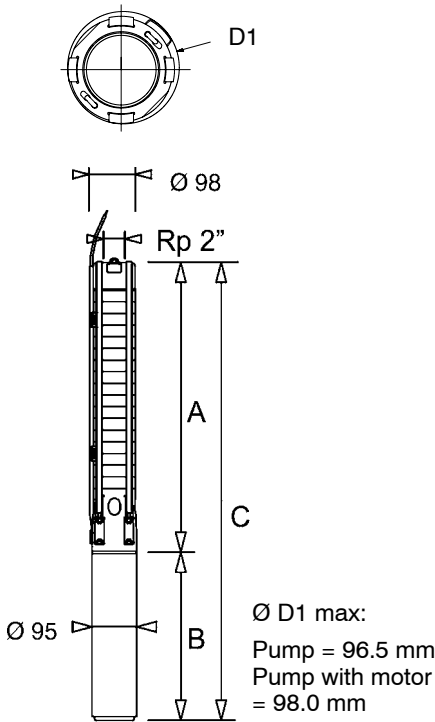

Pump set UPA 100C 12 -..	Rated power (Motor) P_N kW	Rated power (Motor) P_N hp	Rated current for	
			1~ 220 V I_N¹⁾ A	3~ 400 V I_N A
3	1.1	1.5	8.9	3.0
5	1.5	2.0	11.1	3.8
8	2.2	3.0	15.9	5.6
10	3.0	4.0	-	7.2
13	3.7	5.0	-	9.1
14	4.0	5.5	-	10.0
17	5.5	7.5	-	12.5
20	5.5	7.5	-	13.2
24	7.5	10.0	-	18.3
27	7.5	10.0	-	19.1

1) Capacitor run motors (PSC motors) with starter.

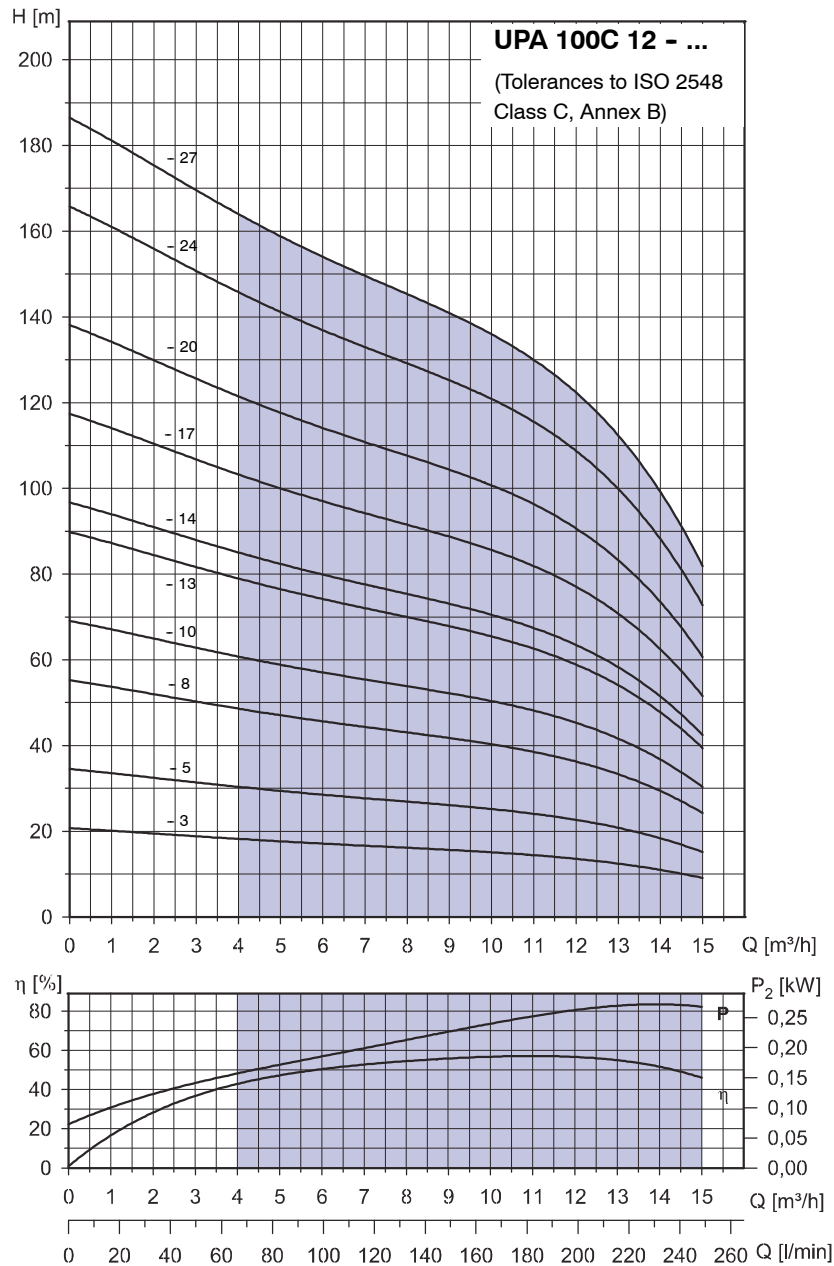

Operating range: 4.0 - 15.0 m³/h
 Q_{min} = 4.0 m³/h
 Q_{max} = End of characteristic curve

The characteristic curves shown are for preliminary selection only.
 Exact selection data will be provided in our quotation.

Dimensions / Weights / Ident. Numbers

Pump set UPA 100C 12 -..	1~ / 220 V				3~ / 400 V			m _A ≈ kg
	A ≈ mm	B ≈ mm	C ≈ mm	Ident. No.	B ≈ mm	C ≈ mm	Ident. No.	
3	327	327	654	90 065 334	299	626	90 065 448	13.9
5	405	356	761	90 065 335	327	732	90 065 449	16.0
8	522	460	982	90 065 336	356	878	90 065 450	18.7
10	600	-	-	-	423	1023	90 065 451	22.1
13	717	-	-	-	545	1265	90 065 452	28.4
14	756	-	-	-	583	1339	90 065 453	29.6
17	873	-	-	-	698	1571	90 065 454	36.4
20	990	-	-	-	698	1688	90 065 455	37.7
24	1146	-	-	-	774	1920	90 065 456	44.1
27	1263	-	-	-	774	2037	90 065 457	45.4

For horizontal installation, a device guiding the flow along the motor (cooling shroud, flow inducer sleeve, etc.) will be required.

Accessories: UPA Control for dry running protection see page 32.

Applications

Suitable for handling clean or slightly contaminated water in applications such as:

- domestic water supply
- general water supply
- irrigation and spray irrigation systems
- artificial lowering of the ground water level as well as
- heat transfer plants

In addition, the pump sets are used in pressure boosting systems, air-conditioning systems, fountains, etc.

Permissible sand content in the fluid handled: 50 g/m³.

Operating Data

Capacity	Q	up to 79 m ³ /h
Head	H	up to 570 m
Temperature of fluid handled . . .	t	up to 50 °C
Speed	n	2900 rpm

Design

Multistage centrifugal pump with components made of stainless steel and additional bearing for each stage. The stage casings are connected by means of tie bolts.

Motor

Canned or wet submersible squirrel-cage motor, 2 poles; NEMA shaft end; 50 Hz; type of enclosure: IP 68

Designation (Example)

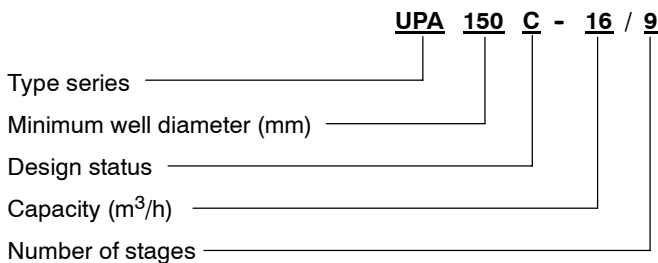

Certification

Quality management certified to ISO 9001

Submersible Borehole Pumps for Well Diameters of 150 mm (6 inches)



Product Features

- Rust-proof
- Suitable for installation in narrow deep wells
- High efficiency
- Motor designed for maximum pump output
- Low noise level
- For vertical, angled or horizontal installation
- Check valve with anti-blockage valve disc

Selection Charts (Ranges on Offer)

n ~ 2900 rpm

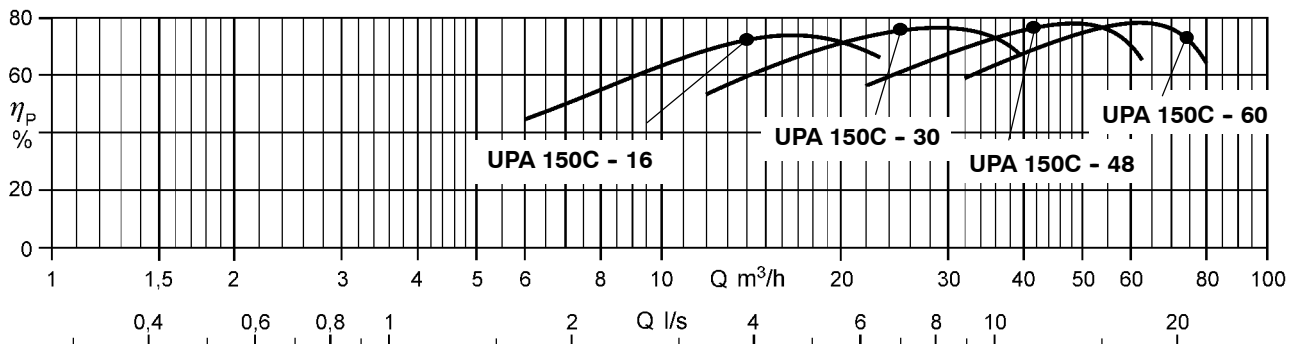
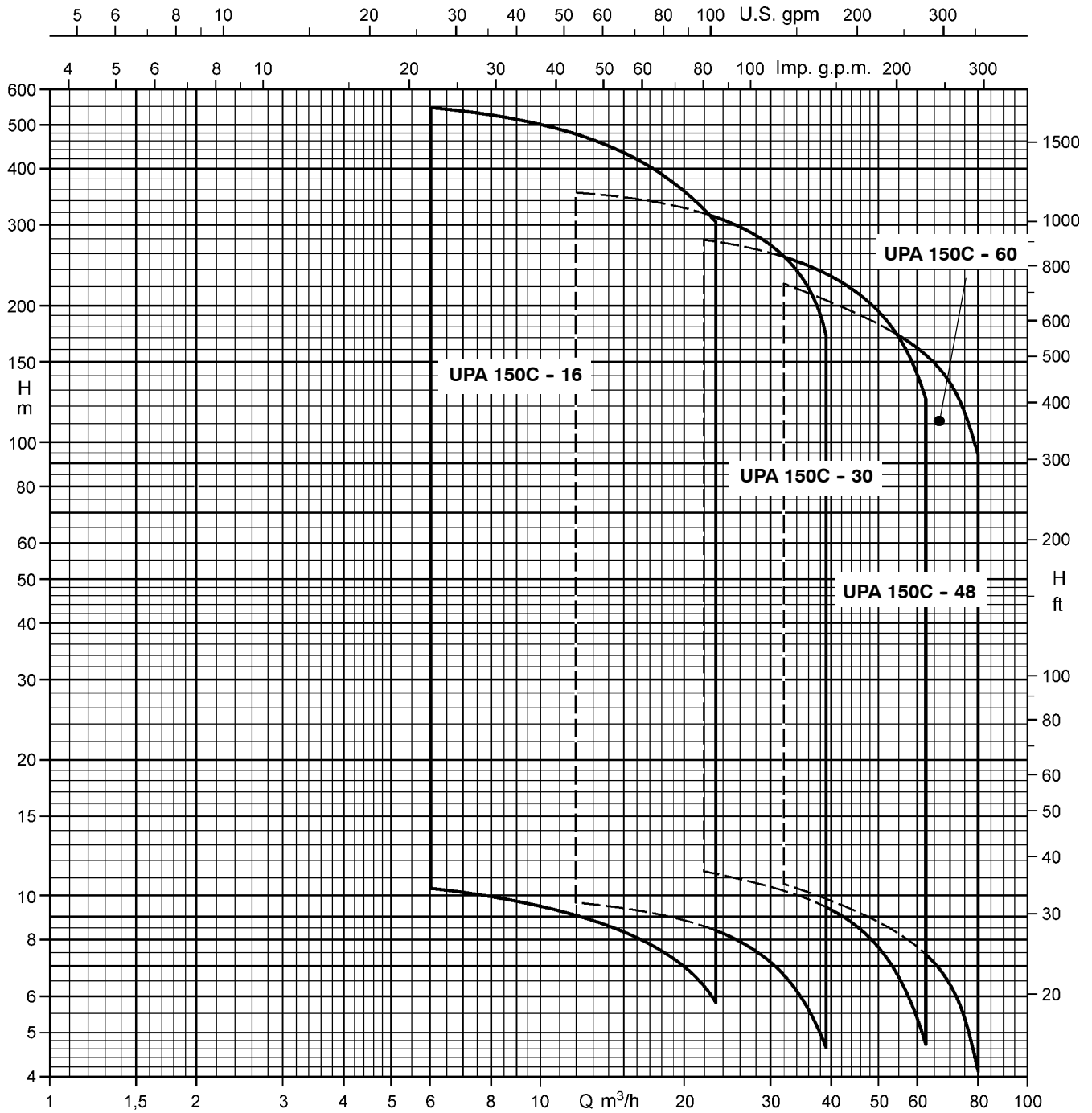

UPA 150C - 16 / ..., number of stages 1 - 20

The characteristic curves shown are for preliminary selection only. Exact selection data will be provided in our quotation.

Selection

The pressure losses H_v in the check valve are not considered in the pump characteristic curves.

Legend ...

H_v : Head losses in the check valve

η_p : Pump efficiency (not considering check valve)

NPSH: Net positive suction head required by the pump

Pump End G 2 1/2"

The information given below is based on the model with check valve and threaded end.

The changes in the main dimensions resulting from different threaded or flanged ends are specified in the table below.

	Overall length (mm)	D_{max} (mm)
G 2 1/2"	40	see page 40
G 3"	48	
G 4"	93	
DN 50	77	165
DN 65	77	185
DN 80	77	200

Threaded end to DIN ISO 228, Part 1.
Flanged end to DIN 2501, Part 1

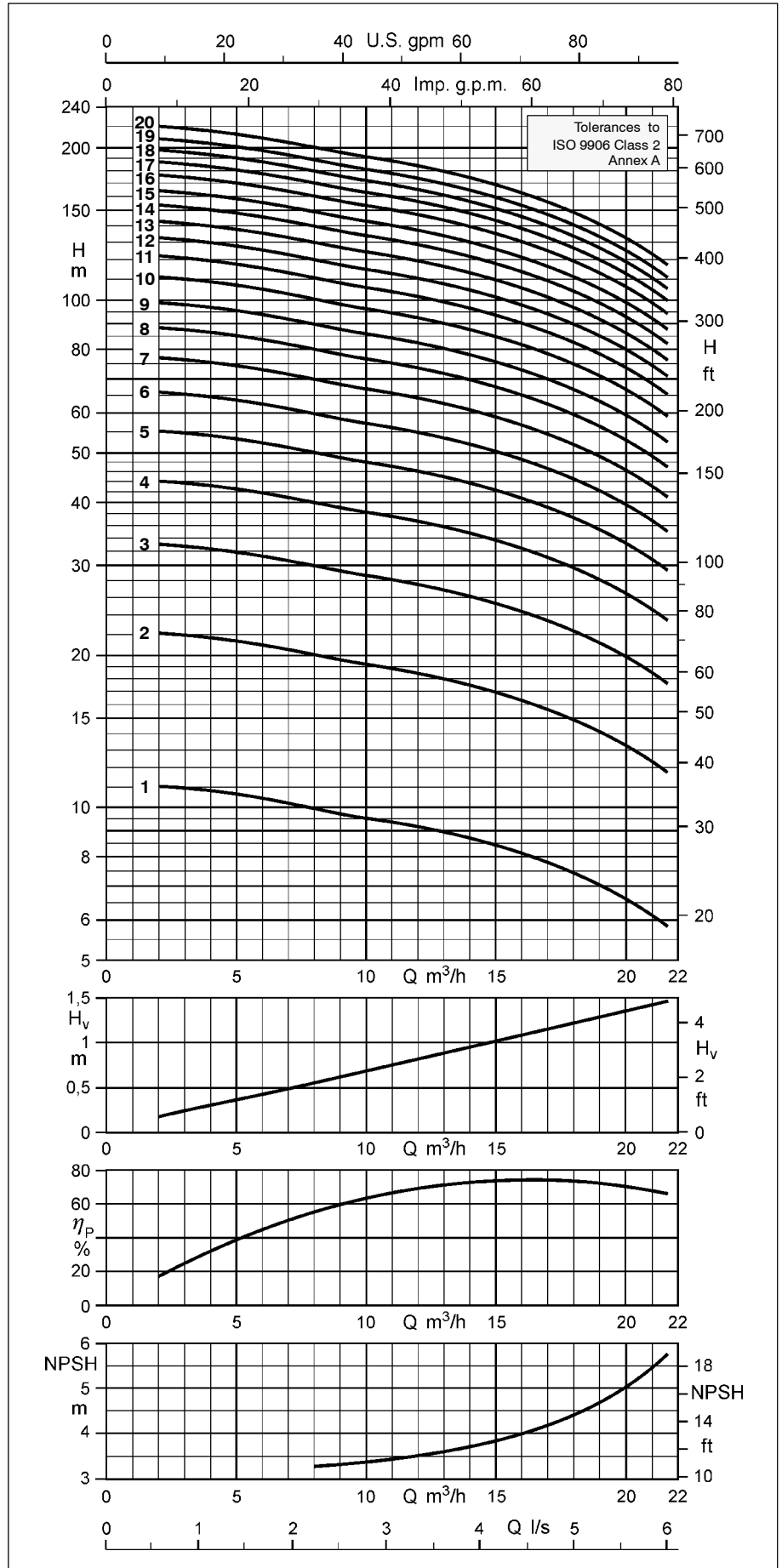
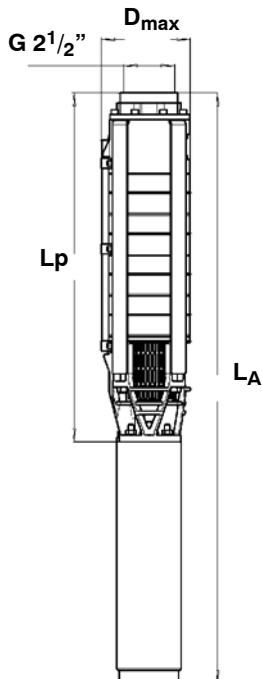

UPA 150C - 16 for Well Diameters of 150 mm (6 inches) and above

Pumps with submersible motors for ... - Type of current / voltage **three-phase (3 ~) / 400 V**
 - Starting **d.o.l. (D) or star-delta (Y-Δ)**

UPA 150C - 16 / ...	Pump		Motor				Motor lead ²⁾ , flat	
	Discharge head Q = 0 m ³ /h H ₀ m	Rated power P _N kW	Max. temperature of the fluid pumped v ≥ 0.2 m/s (0.0 m/s) t _{max} ¹⁾ °C	Rated current I _N A	Efficiency η _M %	Power factor cos φ ---	Number x cross-section of conductors (use under water, 400 V and ≤ +30 °C) d.o.l. mm ²	Y-Δ mm ²
21 + UMA 150D 13/21	236	13.0	30 (24)	29.0	80.0	0.81	4 x 2.5	3/4 x 2.5
22 + UMA 150D 13/21	246	13.0	29 (22)	29.0	80.0	0.81	4 x 2.5	3/4 x 2.5
23 + UMA 150D 13/21	256	13.0	28 (22)	29.0	80.0	0.81	4 x 2.5	3/4 x 2.5
24 + UMA 150D 15/21	269	14.0	33 (28)	30.5	82.0	0.82	4 x 4.0	3/4 x 2.5
25 + UMA 150D 15/21	280	15.0	32 (26)	32.5	81.5	0.83	4 x 4.0	3/4 x 2.5
26 + UMA 150D 15/21	290	15.0	30 (25)	32.5	81.5	0.83	4 x 4.0	3/4 x 2.5
27 + UMA 150D 18/21	305	16.0	32 (27)	36.5	82.5	0.78	4 x 4.0	3/4 x 2.5
28 + UMA 150D 18/21	315	16.5	31 (25)	37.0	82.0	0.79	4 x 4.0	3/4 x 2.5
29 + UMA 150D 18/21	326	17.0	30 (24)	38.0	82.0	0.79	4 x 4.0	3/4 x 2.5
30 + UMA 150D 18/21	336	17.5	29 (22)	39.0	82.0	0.80	4 x 4.0	3/4 x 2.5
31 + UMA 150D 18/21	347	18.0	27 (21)	39.5	82.0	0.81	4 x 4.0	3/4 x 2.5
32 + UMA 150D 18/21	357	18.5	26 (19)	40.5	81.5	0.81	4 x 4.0	3/4 x 2.5
33 + UMA 150D 22/21	373	20.0	33 (28)	44.0	83.5	0.79	4 x 4.0	3/4 x 2.5
34 + UMA 150D 22/21	383	20.0	33 (27)	44.0	83.5	0.79	4 x 4.0	3/4 x 2.5
35 + UMA 150D 22/21	394	21.0	32 (26)	46.0	83.5	0.80	4 x 4.0	3/4 x 2.5
36 + UMA 150D 22/21	404	22.0	31 (25)	47.5	83.5	0.81	4 x 4.0	3/4 x 2.5
37 + UMA 150D 22/21	415	22.0	30 (24)	47.5	83.5	0.81	4 x 4.0	3/4 x 2.5
38 + UMA 150D 22/21	425	22.0	29 (23)	47.5	83.5	0.81	4 x 4.0	3/4 x 2.5
39 + UMA 150D 26/21	441	24.0	36 (31)	52.0	85.0	0.80	4 x 6.0	3/4 x 4.0
40 + UMA 150D 26/21	451	24.0	35 (30)	52.0	85.0	0.80	4 x 6.0	3/4 x 4.0
43 + UMA 150D 26/21	483	26.0	33 (27)	55.0	84.5	0.82	4 x 6.0	3/4 x 4.0
45 + UMA 150D 26/21	504	26.0	31 (26)	55.0	84.5	0.82	4 x 6.0	3/4 x 4.0
48 + UMA 150D 30/21	542	29.0	33 (27)	63.0	84.5	0.80	4 x 6.0	3/4 x 4.0
52 + UMA 150D 30/21	583	30.0	30 (24)	65.0	84.5	0.80	4 x 6.0	3/4 x 4.0

¹⁾ also see page 36

²⁾ 3/4 = 1 x 3-core + 1 x 4-core, 90° spacing.

Dimensions / Weights / Horizontal Installation ¹⁾

UPA 150C - 16 / ...	L _P ≈ mm	L _A ≈ mm	m _A ≈ kg	D _{max} ≈ mm		Installation ²⁾
	for motor UMA	incl. motor UMA	incl. motor UMA	d.o.l. UMA	Y-Δ UMA	
21	1578	2407	95	142	142	v + h
22	1639	2468	97	142	142	v + h
23	1699	2528	98	142	142	v + h
24	1760	2634	103	142	142	v + h
25	1820	2694	104	142	142	v + h
26	1881	2755	105	142	142	v + h
27	1941	2860	112	142	142	v + h
28	2002	2921	113	142	142	v + h
29	2062	2981	114	142	142	v + h
30	2123	3042	116	142	142	v + h
31	2183	3102	117	142	142	v + h
32	2244	3163	118	142	142	v + h
33	2304	3313	128	142	142	v + h
34	2365	3374	129	142	142	v + h
35	2425	3434	130	142	142	v + h
36	2486	3495	132	142	142	v + h
37	2546	3555	133	142	142	v + h
38	2607	3616	135	142	142	v + h
39	2667	3781	145	142	142	v + h
40	2728	3842	146	142	142	v + h
43						
45						
48						
52						

¹⁾ Including check valve with threaded end and standard motor leads.

²⁾ v = vertical / h = horizontal.

on request

UPA 150C - 16 / ..., number of stages 21 - 52

The characteristic curves shown are for preliminary selection only. Exact selection data will be provided in our quotation.

Selection

The pressure losses H_v in the check valve are not considered in the pump characteristic curves.

Legend ...

H_v : Head losses in the check valve

η_p : Pump efficiency (not considering check valve)

NPSH: Net positive suction head required by the pump

Pump End G 2 1/2"

The information given below is based on the model with check valve and threaded end.

The changes in the main dimensions resulting from different threaded or flanged ends are specified in the table below.

	Overall length (mm)	D_{max} (mm)
G 2 1/2"	40	see page 42
G 3"	48	
G 4"	93	
DN 50	77	165
DN 65	77	185
DN 80	77	200

Threaded end to DIN ISO 228, Part 1.
Flanged end to DIN 2501, Part 1

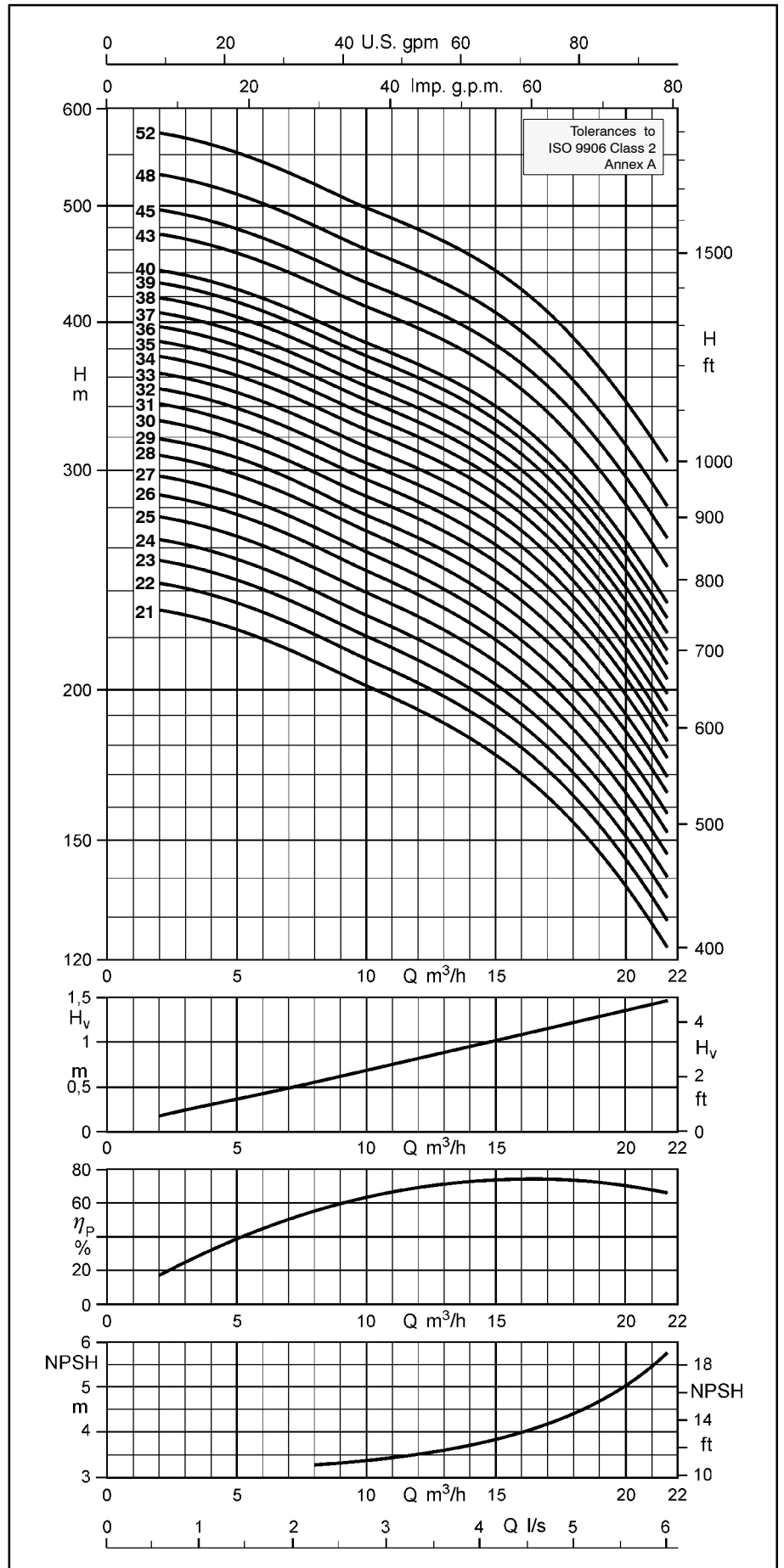
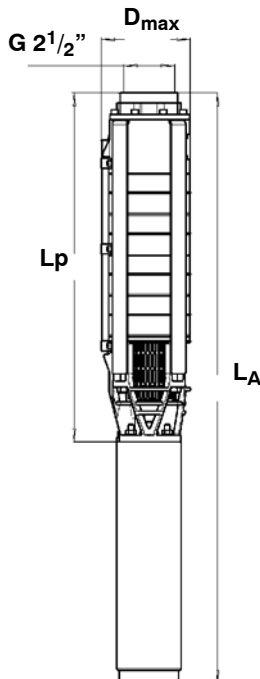

UPA 150C - 30 for Well Diameters of 150 mm (6 inches) and above

Pumps with submersible motors for ... - Type of current / voltage **three-phase (3 ~) / 400 V**
 - Starting **d.o.l. (D) or star-delta (Y-Δ)**

UPA 150C - 30 / ...	Pump		Motor				Motor lead ²⁾ , flat	
	Discharge head Q = 0 m ³ /h H ₀ m	Rated power P _N kW	Max. temperature of the fluid pumped v ≥ 0.2 m/s (0.0 m/s) t _{max} ¹⁾ °C	Rated current I _N A	Efficiency η _M %	Power factor cos φ ---	Number x cross-section of conductors (use under water, 400 V and ≤ +30 °C) d.o.l. mm ²	Y-Δ mm ²
1 + DN 100 - 1.1	10.6	1.1	30 (30)	3.1	73.5	0.71	4 x 1.5	-
2 + DN 100 - 2.2	21.5	2.2	30 (30)	6.2	75.0	0.75	4 x 1.5	-
3 + DN 100 - 3.0	32.0	3.0	30 (30)	8.0	76.0	0.76	4 x 1.5	-
4 + DN 100 - 3.7	43.0	3.7	30 (30)	9.2	77.5	0.80	4 x 1.5	-
5 + UMA 150D 5/21	56.0	4.5	41 (38)	12.0	76.5	0.74	4 x 2.5	3/4 x 2.5
5 + DN 100 - 5.5	55.0	5.5	30 (20)	13.0	76.5	0.80	4 x 1.5	-
6 + UMA 150D 5/21	67.0	5.5	37 (33)	13.6	75.5	0.80	4 x 2.5	3/4 x 2.5
6 + DN 100 - 5.5	66.0	5.5	30 (20)	13.0	76.5	0.80	4 x 1.5	-
7 + UMA 150D 7/21	78.0	6.5	37 (33)	16.0	77.5	0.79	4 x 2.5	3/4 x 2.5
7 + DN 100 - 7.5	76.0	7.5	30 (20)	18.4	74.0	0.79	4 x 1.5	-
8 + UMA 150D 7/21	88.0	7.0	33 (29)	16.8	77.0	0.81	4 x 2.5	3/4 x 2.5
9 + UMA 150D 9/21	100.0	8.0	35 (30)	19.0	78.5	0.80	4 x 2.5	3/4 x 2.5
10 + UMA 150D 9/21	110.0	9.0	31 (26)	20.5	78.0	0.82	4 x 2.5	3/4 x 2.5
11 + UMA 150D 9/21	120.0	9.3	28 (22)	21.0	77.5	0.83	4 x 2.5	3/4 x 2.5
12 + UMA 150D 13/21	134.0	11.0	35 (31)	25.5	80.5	0.78	4 x 2.5	3/4 x 2.5
13 + UMA 150D 13/21	144.0	11.5	33 (28)	26.5	80.5	0.79	4 x 2.5	3/4 x 2.5
14 + UMA 150D 13/21	154.0	12.5	31 (25)	28.0	80.5	0.80	4 x 2.5	3/4 x 2.5
15 + UMA 150D 13/21	165.0	13.0	29 (22)	29.0	80.0	0.81	4 x 2.5	3/4 x 2.5
16 + UMA 150D 15/21	176.0	14.5	33 (28)	31.5	82.0	0.82	4 x 4.0	3/4 x 2.5
17 + UMA 150D 15/21	186.0	15.0	31 (25)	32.5	81.5	0.83	4 x 4.0	3/4 x 2.5
18 + UMA 150D 18/21	200.0	16.0	32 (27)	36.5	82.5	0.78	4 x 4.0	3/4 x 2.5

¹⁾ also see page 36 ²⁾ 3/4 = 1 x 3-core + 1 x 4-core, 90° spacing.

Dimensions / Weights / Horizontal Installation ¹⁾

UPA 150C - 30 / ...	L _p ≈ mm for motor		L _A ≈ mm incl. motor		m _A ≈ kg incl. motor		D _{max} ≈ mm			Installation ²⁾
	DN	UMA	DN	UMA	DN	UMA	d.o.l. DN	d.o.l. UMA	Y-Δ UMA	
1	389	--	690	--	18	--	139	--	--	v + h
2	485	--	840	--	23	--	139	--	--	v + h
3	581	--	1005	--	27	--	139	--	--	v + h
4	677	--	1235	--	36	--	139	--	--	v + h
5	773	805	1478	1505	44	63	139	146	148	v + h
6	869	901	1574	1600	46	65	139	146	148	v + h
7	965	997	1739	1715	51	68	139	146	148	v + h
8	--	1093	--	1810	--	70	--	146	148	v + h
9	--	1189	--	1940	--	74	--	146	148	v + h
10	--	1285	--	2035	--	76	--	146	148	v + h
11	--	1381	--	2130	--	77	--	146	148	v + h
12	--	1477	--	2305	--	86	--	146	148	v + h
13	--	1573	--	2400	--	88	--	146	148	v + h
14	--	1669	--	2500	--	89	--	146	148	v + h
15	--	1765	--	2595	--	91	--	146	148	v + h
16	--	1861	--	2735	--	96	--	147	148	v + h
17	--	1957	--	2830	--	98	--	147	148	v + h
18	--	2053	--	2970	--	104	--	147	148	v + h

¹⁾ Including check valve with threaded end and standard motor leads. ²⁾ v = vertical / h = horizontal.

UPA 150C - 30 / ..., number of stages 1 - 18

The characteristic curves shown are for preliminary selection only. Exact selection data will be provided in our quotation.

Selection

The pressure losses H_v in the check valve are not considered in the pump characteristic curves.

Legend ...

H_v : Head losses in the check valve

η_p : Pump efficiency (not considering check valve)

NPSH: Net positive suction head required by the pump

Pump End G 3"

The information given below is based on the model with check valve and threaded end.

The changes in the main dimensions resulting from different threaded or flanged ends are specified in the table below.

	Overall length (mm)	D_{max} (mm)
G 3"	48	see page 44
G 4"	93	see page 44
DN 65	77	185
DN 80	77	200

Threaded end to DIN ISO 228, Part 1.
Flanged end to DIN 2501, Part 1

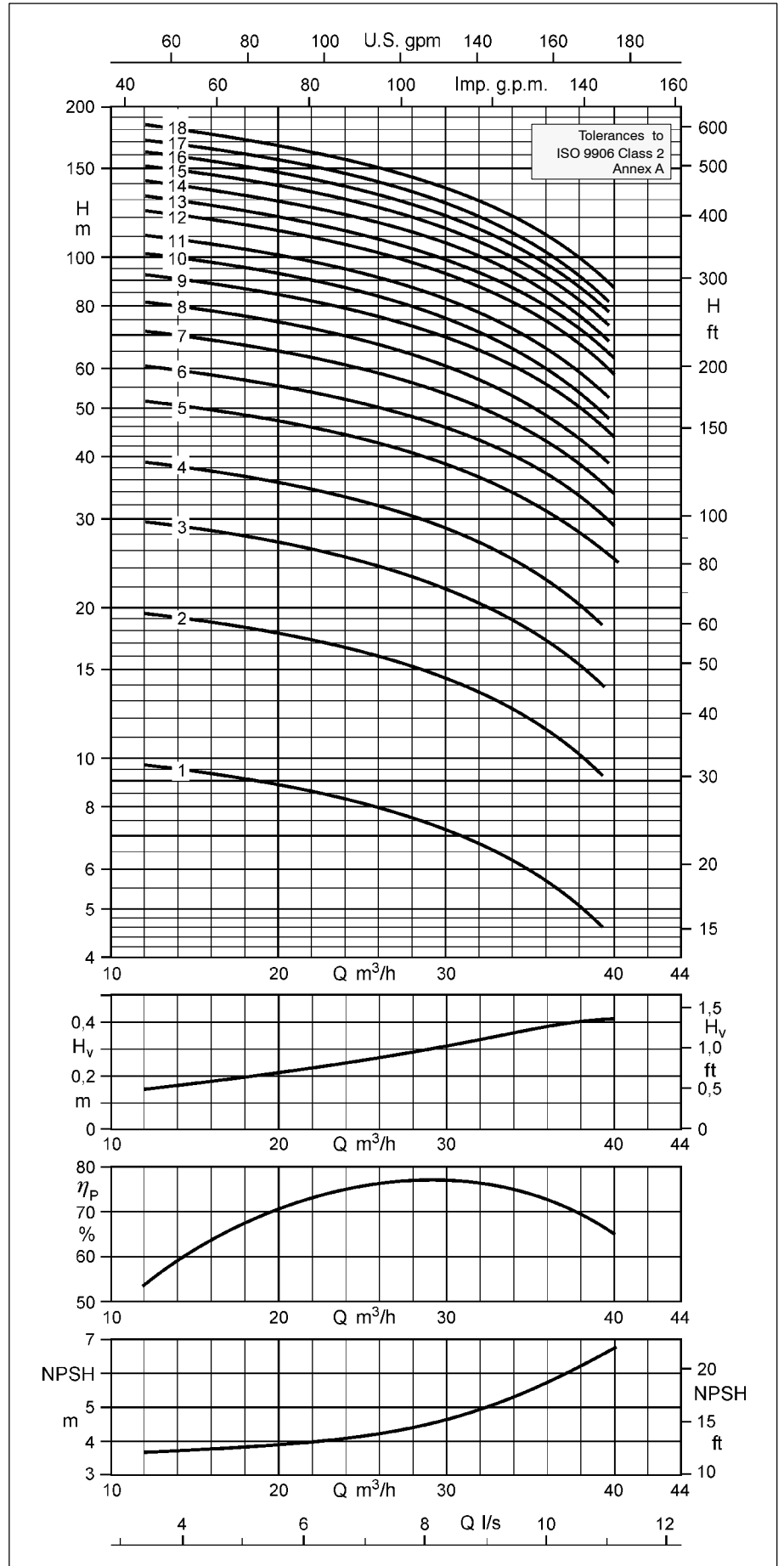
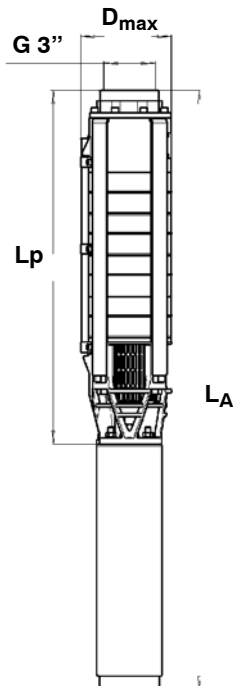

UPA 150C - 30 for Well Diameters of 150 mm (6 inches) and above

Pumps with submersible motors for ... - Type of current / voltage **three-phase (3 ~) / 400 V**
 - Starting **d.o.l. (D) or star-delta (Y-Δ)**

UPA 150C - 30 / ...	Pump		Motor				Motor lead ²⁾ , flat	
	Discharge head Q = 0 m ³ /h H ₀ m	Rated power P _N kW	Max. temperature of the fluid pumped v ≥ 0.2 m/s (0.0 m/s) t _{max} ¹⁾ °C	Rated current I _N A	Efficiency η _M %	Power factor cos φ ---	Number x cross-section of conductors (use under water, 400 V and ≤ +30 °C) d.o.l. mm ²	Y-Δ mm ²
19 + UMA 150D 18/21	210.0	17.0	30 (24)	38.0	82.0	0.79	4 x 4.0	3/4 x 2.5
20 + UMA 150D 18/21	220.0	18.0	29 (22)	39.5	82.0	0.81	4 x 4.0	3/4 x 2.5
21 + UMA 150D 18/21	230.0	18.5	27 (20)	40.5	81.5	0.81	4 x 4.0	3/4 x 2.5
22 + UMA 150D 22/21	244.0	20.0	33 (28)	44.0	83.5	0.79	4 x 4.0	3/4 x 2.5
23 + UMA 150D 22/21	254.0	21.0	32 (26)	46.0	83.5	0.80	4 x 4.0	3/4 x 2.5
24 + UMA 150D 22/21	265.0	22.0	31 (25)	47.5	83.5	0.81	4 x 4.0	3/4 x 2.5
25 + UMA 150D 22/21	275.0	22.0	29 (23)	47.5	83.5	0.81	4 x 4.0	3/4 x 2.5
26 + UMA 150D 26/21	289.0	24.0	36 (31)	52.0	85.0	0.80	4 x 6.0	3/4 x 4.0
27 + UMA 150D 26/21	299.0	24.0	35 (30)	52.0	85.0	0.80	4 x 6.0	3/4 x 4.0
28 + UMA 150D 26/21	309.0	25.0	34 (28)	53.0	85.0	0.81	4 x 6.0	3/4 x 4.0
29 + UMA 150D 26/21	320.0	26.0	32 (27)	55.0	84.5	0.82	4 x 6.0	3/4 x 4.0
30 + UMA 150D 26/21	330.0	26.0	31 (26)	55.0	84.5	0.82	4 x 6.0	3/4 x 4.0
31 + UMA 150D 30/21	345.0	28.0	34 (28)	61.0	84.5	0.79	4 x 6.0	3/4 x 4.0
32 + UMA 150D 30/21	355.0	29.0	33 (27)	63.0	84.5	0.80	4 x 6.0	3/4 x 4.0
33 + UMA 150D 30/21	365.0	30.0	32 (26)	65.0	84.5	0.80	4 x 6.0	3/4 x 4.0
34 + UMA 150D 30/21	376.0	30.0	31 (25)	65.0	84.5	0.80	4 x 6.0	3/4 x 4.0
35 + UMA 150D 37/22	389.0	32.0	46 (41)	71.0	84.0	0.78	3/4 x 4.0 ³⁾	3/4 x 4.0

¹⁾ also see page 36 ²⁾ 3/4 = 1 x 3-core + 1 x 4-core, 90° spacing. ³⁾ Parallel cable

Dimensions / Weights / Horizontal Installation ¹⁾

UPA 150C - 30 / ...	L _p ≈ mm	L _A ≈ mm	m _A ≈ kg	D _{max} ≈ mm		Installation ²⁾
	for motor	incl. motor	incl. motor	d.o.l.	Y-Δ	
	UMA	UMA	UMA	UMA	UMA	
19	2149	3070	105	147	148	v ³⁾
20	2245	3165	107	147	148	v ³⁾
21	2341	3260	108	147	148	v ³⁾
22	2437	3445	118	147	148	v ³⁾
23	2533	3540	119	147	148	v ³⁾
24	2629	3640	121	147	148	v ³⁾
25	2725	3735	123	147	148	v ³⁾
26	2821	3935	133	149	149	v ³⁾
27	2917	4030	135	149	149	v ³⁾
28	3013	4125	136	149	149	v ³⁾
29	3109	4225	138	149	149	v ³⁾
30	3205	4320	140	149	149	v ³⁾
31	3301	4515	150	149	149	v ³⁾
32	3397	4610	152	149	149	v ³⁾
33	3493	4705	153	149	149	v ³⁾
34	3589	4805	155	149	149	v ³⁾

Including check valve with threaded end and standard motor leads.

²⁾ v = vertical / h = horizontal.

³⁾ Horizontal installation on request

UPA 150C - 30 / ..., number of stages 19 - 35

The characteristic curves shown are for preliminary selection only. Exact selection data will be provided in our quotation.

Selection

The pressure losses H_v in the check valve are not considered in the pump characteristic curves.

Legend ...

H_v : Head losses in the check valve

η_p : Pump efficiency (not considering check valve)

NPSH: Net positive suction head required by the pump

Pump End G 3"

The information given below is based on the model with check valve and threaded end.

The changes in the main dimensions resulting from different threaded or flanged ends are specified in the table below.

	Overall length (mm)	D_{max} (mm)
G 3"	48	see page 46
G 4"	93	see page 46
DN 65	77	185
DN 80	77	200

Threaded end to DIN ISO 228, Part 1.
Flanged end to DIN 2501, Part 1

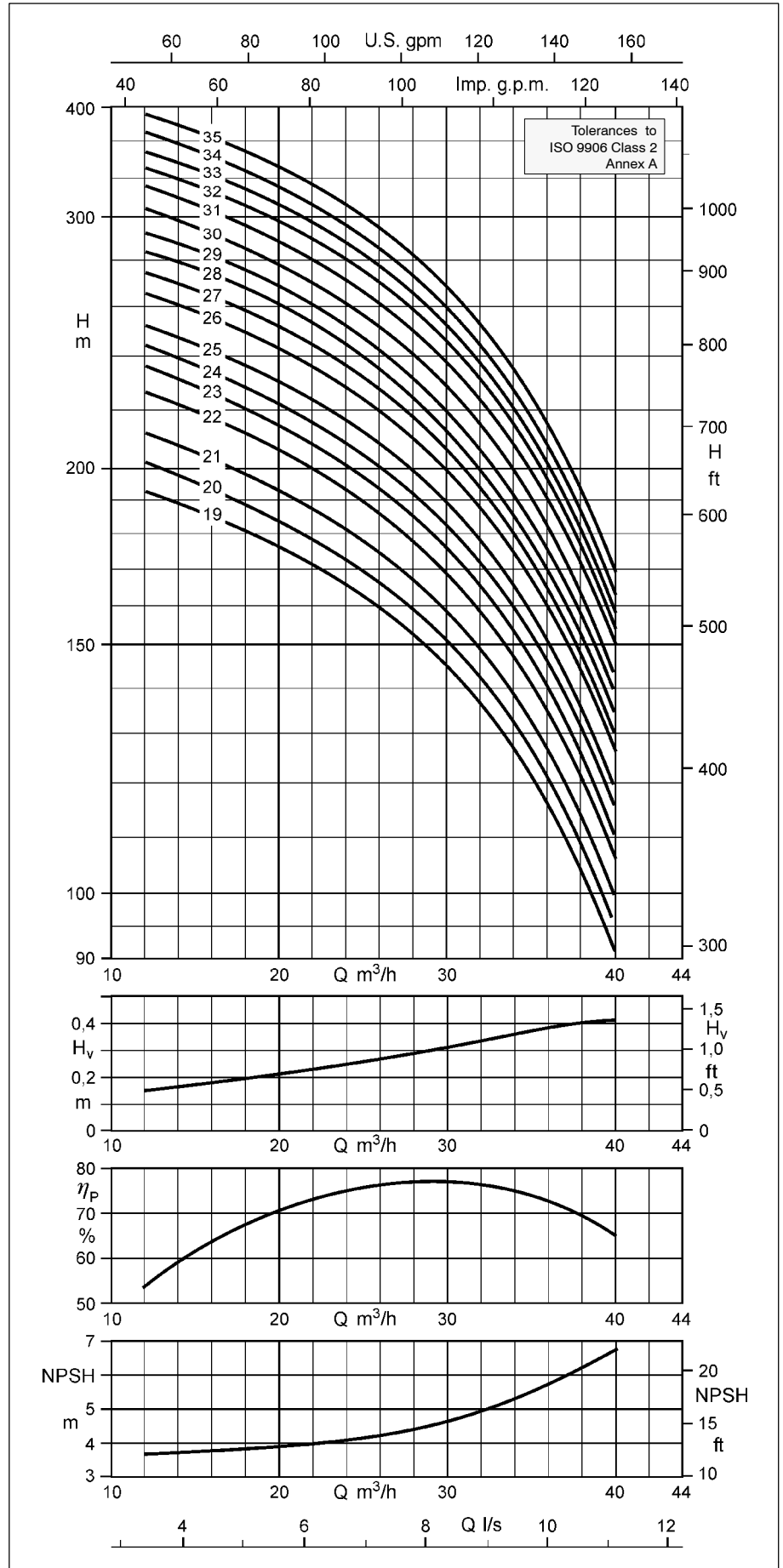
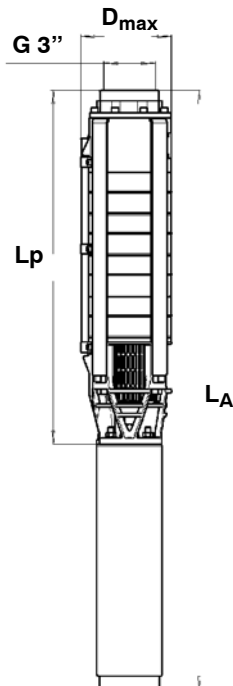

UPA 150C - 48 for Well Diameters of 150 mm (6 inches) and above

Pumps with submersible motors for ... - Type of current / voltage **three-phase (3 ~) / 400 V**
 - Starting **d.o.l. (D) or star-delta (Y-Δ)**

UPA 150C - 48 / ...	Pump		Motor				Motor lead ²⁾ , flat	
	Discharge head Q = 0 m ³ /h	Rated power	Max. temperature of the fluid pumped v ≥ 0.2 m/s (0.0 m/s)	Rated current	Efficiency	Power factor	Number x cross-section of conductors (use under water, 400 V and ≤ +30 °C)	
	H ₀ m	P _N kW	t _{max} ¹⁾ °C	I _N A	η _M %	cos φ ---	d.o.l. mm ²	Y-Δ mm ²
1 + DN 100 - 2.2	13.2	2.2	30 (30)	6.2	75.0	0.75	4 x 1.5	-
2 + DN 100 - 3.0	26.5	3.0	30 (30)	8.0	76.0	0.76	4 x 1.5	-
3 + UMA 150D 5/21	42.0	5.0	40 (36)	12.7	76.0	0.78	4 x 2.5	3/4 x 2.5
3 + DN 100 - 5.5	41.0	5.5	30 (20)	13.0	76.5	0.80	4 x 1.5	-
4 + UMA 150D 7/21	55.0	6.5	37 (32)	16.0	77.5	0.79	4 x 2.5	3/4 x 2.5
4 + DN 100 - 7.5	54.0	7.5	30 (20)	18.4	74.0	0.79	4 x 1.5	-
5 + UMA 150D 9/21	69.0	8.0	35 (30)	19.0	78.5	0.80	4 x 2.5	3/4 x 2.5
6 + UMA 150D 9/21	81.0	9.3	29 (23)	21.0	77.5	0.83	4 x 2.5	3/4 x 2.5
7 + UMA 150D 13/21	97.0	11.5	34 (29)	26.5	80.5	0.79	4 x 2.5	3/4 x 2.5
8 + UMA 150D 13/21	109.0	12.5	30 (25)	28.0	80.5	0.80	4 x 2.5	3/4 x 2.5
9 + UMA 150D 15/21	123.0	14.5	33 (28)	31.5	82.0	0.82	4 x 4.0	3/4 x 2.5
10 + UMA 150D 18/21	138.0	16.0	32 (27)	36.5	82.5	0.78	4 x 4.0	3/4 x 2.5
11 + UMA 150D 18/21	151.0	17.5	29 (23)	39.0	82.0	0.80	4 x 4.0	3/4 x 2.5
12 + UMA 150D 18/21	163.0	18.5	26 (19)	40.5	81.5	0.81	4 x 4.0	3/4 x 2.5
13 + UMA 150D 22/21	179.0	21.0	32 (26)	46.0	83.5	0.80	4 x 4.0	3/4 x 2.5
14 + UMA 150D 22/21	191.0	22.0	29 (23)	47.5	83.5	0.81	4 x 4.0	3/4 x 2.5

1) also see page 36

2) 3/4 = 1 x 3-core + 1 x 4-core, 90° spacing.

Dimensions / Weights / Horizontal Installation ¹⁾

UPA 150C - 48 / ...	L _p ≈ mm		L _A ≈ mm		m _A ≈ kg		D _{max} ≈ mm			Installation ²⁾
	for motor		incl. motor		incl. motor		d.o.l.	d.o.l.	Y-Δ	
	DN	UMA	DN	UMA	DN	UMA	DN	UMA	UMA	
1	406	--	765	--	23.0	--	139	--	--	v + h
2	519	--	945	--	29.1	--	139	--	--	v + h
3	632	664	1337	1365	43.0	63.3	139	143	146	v + h
4	745	777	1519	1500	49.2	67.6	139	143	146	v + h
5	--	890	--	1640	--	72.9	--	143	146	v + h
6	--	1003	--	1755	--	75.1	--	143	146	v + h
7	--	1116	--	1945	--	84.4	--	143	146	v + h
8	--	1229	--	2060	--	86.7	--	143	146	v + h
9	--	1342	--	2220	--	92.9	--	145	146	v + h
10	--	1455	--	2375	--	99.2	--	145	146	v + h
11	--	1568	--	2490	--	101.5	--	145	146	v + h
12	--	1681	--	2600	--	103.7	--	145	146	v + h
13	--	1794	--	2805	--	114.0	--	145	146	v + h
14	--	1907	--	2920	--	116.3	--	145	146	v + h

1) Including check valve with threaded end and standard motor leads.

2) v = vertical / h = horizontal.

UPA 150C - 48 / ..., number of stages 1 - 14

The characteristic curves shown are for preliminary selection only. Exact selection data will be provided in our quotation.

Selection

The pressure losses H_v in the check valve are not considered in the pump characteristic curves.

Legend ...

H_v : Head losses in the check valve

η_p : Pump efficiency (not considering check valve)

NPSH: Net positive suction head required by the pump

Pump End G 3"

The information given below is based on the model with check valve and threaded end.

The changes in the main dimensions resulting from different threaded or flanged ends are specified in the table below.

	Overall length (mm)	D_{max} (mm)
G 3"	48	see page 48
G 4"	93	page 48
DN 80	77	200

Threaded end to DIN ISO 228, Part 1.
Flanged end to DIN 2501, Part 1

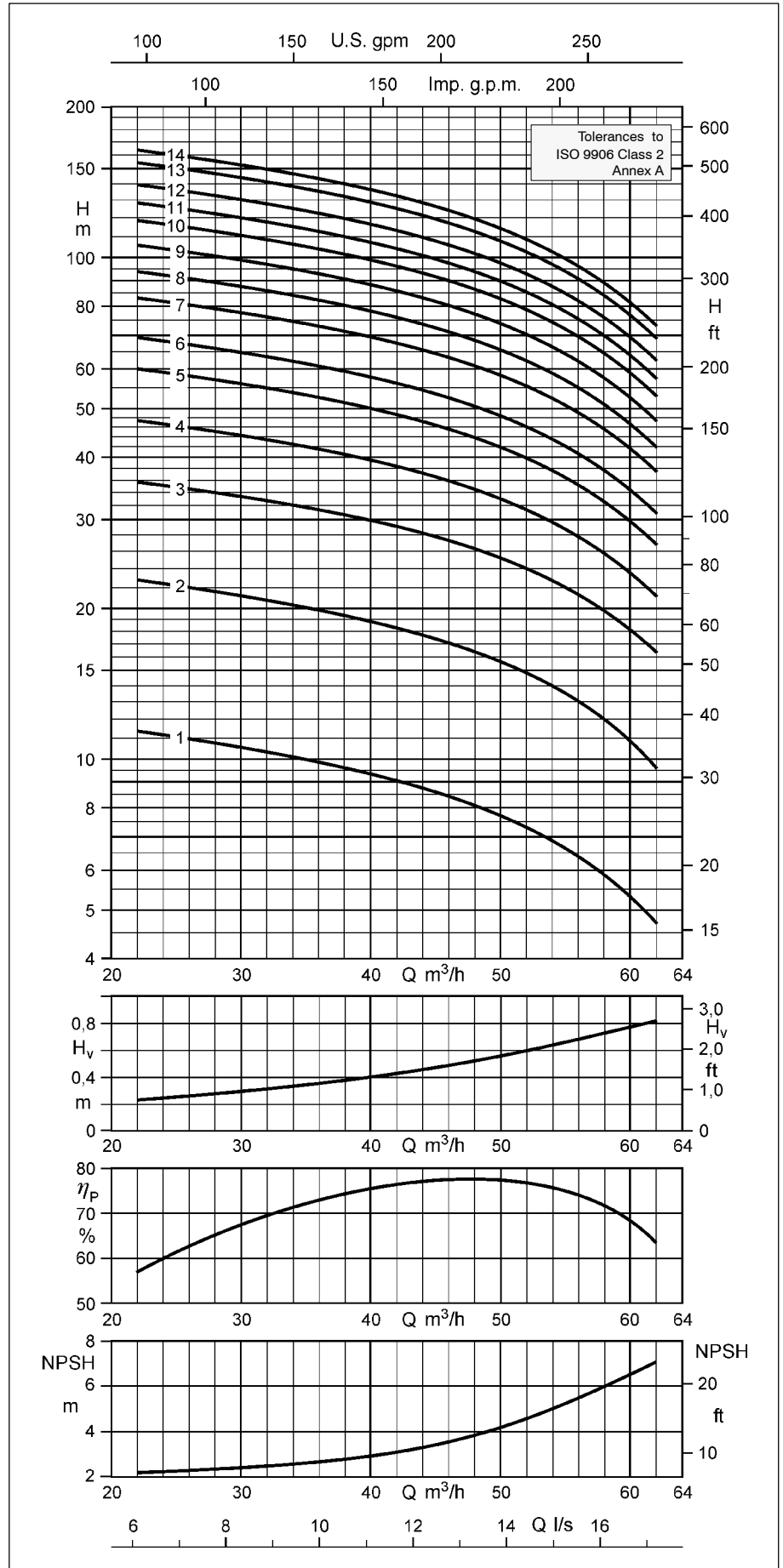
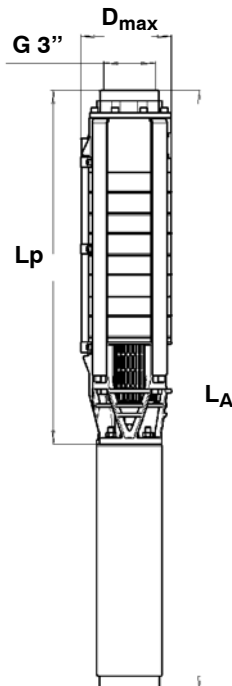

UPA 150C - 48 for Well Diameters of 150 mm (6 inches) and above

 Pumps with submersible motors for ... - Type of current / voltage **three-phase (3 ~) / 400 V**
 - Starting **d.o.l. (D) or star-delta (Y-Δ)**

UPA 150C - 48 / ...	Pump		Motor				Motor lead ²⁾ , flat	
	Discharge head Q = 0 m ³ /h H₀ m	Rated power P_N kW	Max. temperature of the fluid pumped v ≥ 0.2 m/s (0.0 m/s) t_{max} ¹⁾ °C	Rated current I_N A	Efficiency η_M %	Power factor cos φ ---	Number x cross-section of conductors (use under water, 400 V and ≤ +30 °C) d.o.l. mm ²	Y-Δ mm ²
15 + UMA 150D 26/21	207.0	24.0	35 (30)	52.0	85.0	0.80	4 x 6.0	3/4 x 4.0
16 + UMA 150D 26/21	219.0	26.0	33 (28)	55.0	84.5	0.82	4 x 6.0	3/4 x 4.0
17 + UMA 150D 26/21	232.0	26.0	31 (25)	55.0	84.5	0.82	4 x 6.0	3/4 x 4.0
18 + UMA 150D 30/21	248.0	29.0	33 (27)	63.0	84.5	0.80	4 x 6.0	3/4 x 4.0
19 + UMA 150D 30/21	261.0	30.0	31 (25)	65.0	84.5	0.80	4 x 6.0	3/4 x 4.0
20 + UMA 150D 37/22	276.0	32.0	45 (40)	71.0	84.0	0.78	3/4 x 4.0 ³⁾	3/4 x 4.0
21 + UMA 150D 37/22	289.0	33.0	44 (38)	72.0	84.0	0.79	3/4 x 4.0 ³⁾	3/4 x 4.0
22 + UMA 150D 37/22	301.0	35.0	42 (36)	76.0	84.0	0.80	3/4 x 4.0 ³⁾	3/4 x 4.0
23 + UMA 150D 37/22	314.0	36.0	41 (35)	77.0	83.5	0.81	3/4 x 4.0 ³⁾	3/4 x 4.0
24 + UMA 150D 37/22	327.0	37.0	39 (33)	79.0	83.5	0.82	3/4 x 4.0 ³⁾	3/4 x 4.0

¹⁾ also see page 36

²⁾ 3/4 = 1 x 3-core + 1 x 4-core, 90° spacing.

³⁾ Parallel cable

Dimensions / Weights / Horizontal Installation ¹⁾

UPA 150C - 48 / ...	L _P ≈ mm	L _A ≈ mm	m _A ≈ kg	D _{max} ≈ mm		Installation ²⁾
	for motor	incl. motor	incl. motor	d.o.l.	Y-Δ	
	UMA	UMA	UMA	UMA	UMA	
15	2020	3135	128.0	146	147	v ³⁾
16	2133	3250	130.0	146	147	v ³⁾
17	2246	3360	132.0	146	147	v ³⁾
18	2359	3575	143.0	146	147	v ³⁾
19	2472	3690	146.0	146	147	v ³⁾
20	2585	3880	155.0	145	147	v ³⁾
21	2698	3995	157.0	145	147	v ³⁾
22	2811	4105	159.0	145	147	v ³⁾
23	2924	4220	162.0	145	147	v ³⁾
24	3037	4335	164.0	145	147	v ³⁾

¹⁾ Including check valve with threaded end and standard motor leads.

²⁾ v = vertical / h = horizontal.

³⁾ Horizontal installation on request

UPA 150C - 48 / ..., number of stages 15 - 24

The characteristic curves shown are for preliminary selection only. Exact selection data will be provided in our quotation.

Selection

The pressure losses H_v in the check valve are not considered in the pump characteristic curves.

Legend ...

H_v : Head losses in the check valve

η_p : Pump efficiency (not considering check valve)

NPSH: Net positive suction head required by the pump

Pump End G 3"

The information given below is based on the model with check valve and threaded end.

The changes in the main dimensions resulting from different threaded or flanged ends are specified in the table below.

	Overall length (mm)	D_{max} (mm)
G 3"	48	see page 50
G 4"	93	see page 50
DN 80	77	200

Threaded end to DIN ISO 228, Part 1.
Flanged end to DIN 2501, Part 1

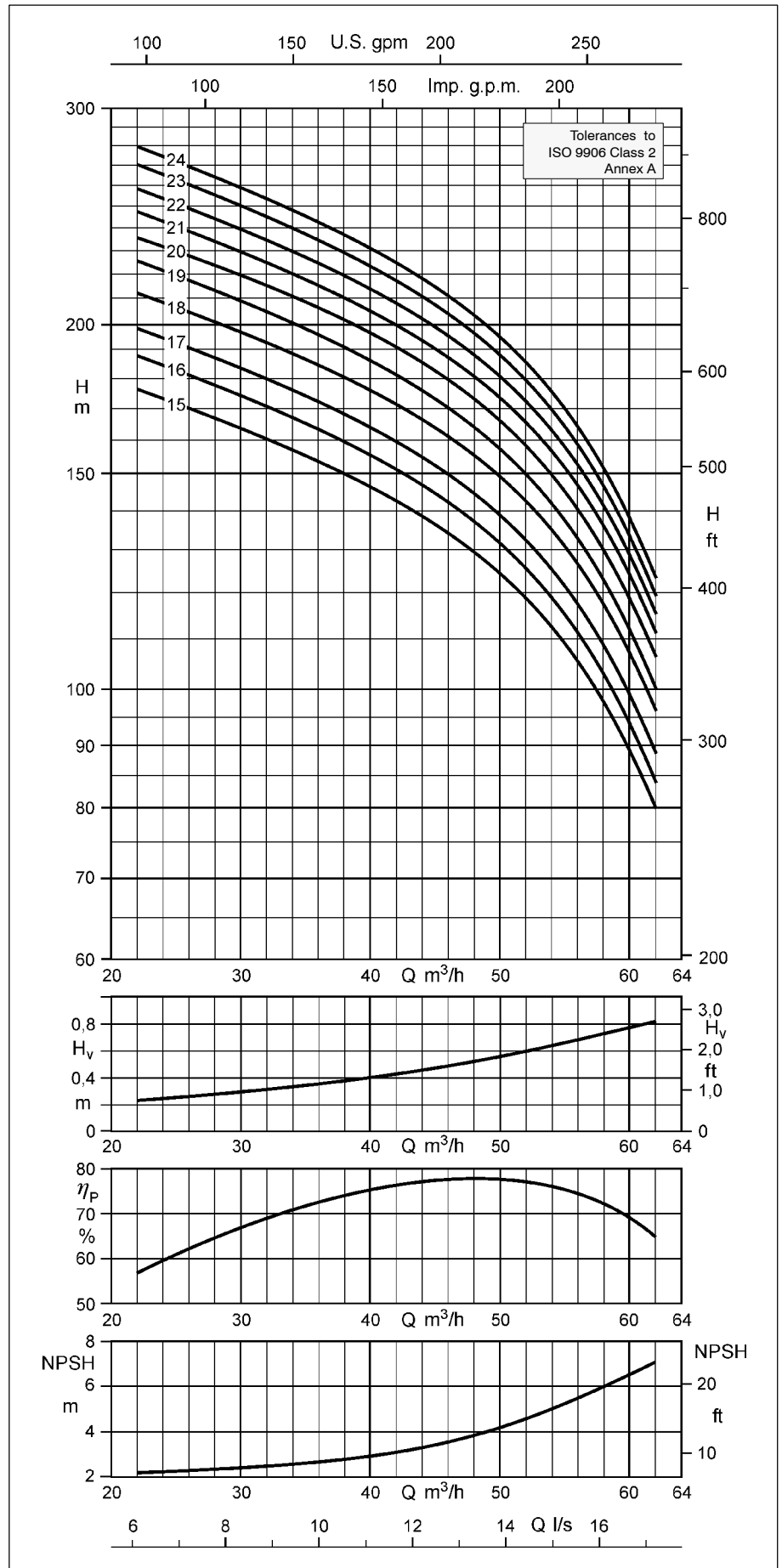
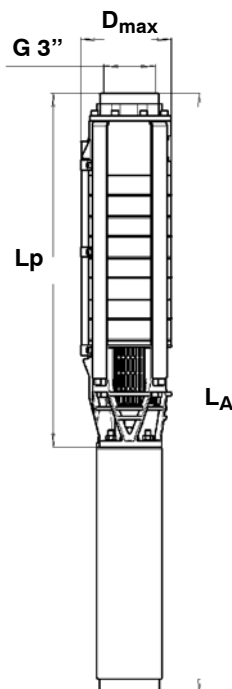

UPA 150C - 60 for Well Diameters of 150 mm (6 inches) and above

Pumps with submersible motors for ... - Type of current / voltage **three-phase (3 ~) / 400 V**
 - Starting **d.o.l. (D) or star-delta (Y-Δ)**

UPA 150C - 60 / ...	Pump		Motor				Motor lead ²⁾ , flat		
	Discharge head Q = 0 m ³ /h H ₀ m	Rated power P _N kW	Max. temperature of the fluid pumped v ≥ 0.2 m/s (0.0 m/s) t _{max} ¹⁾ °C		Rated current I _N A	Efficiency η _M %	Power factor cos φ ---	Number x cross-section of conductors (use under water, 400 V and ≤ +30 °C) d.o.l. mm ²	Y-Δ mm ²
1 + DN 100 - 2.2	13.4	2.2	30 (30)		6.2	75.0	0.75	4 x 1.5	-
2 + DN 100 - 3.7	27.0	3.7	30 (30)		9.2	77.5	0.80	4 x 1.5	-
3 + UMA 150D 7/21	42.0	6.0	39 (35)		15.1	77.5	0.77	4 x 2.5	3/4 x 2.5
3 + DN 100 - 7.5	41.0	7.5	30 (20)		18.4	74.0	0.79	4 x 1.5	-
4 + UMA 150D 7/21	55.0	7.5	31 (26)		17.8	76.5	0.82	4 x 2.5	3/4 x 2.5
4 + DN 100 - 7.5	53.0	7.5	30 (20)		18.4	74.0	0.79	4 x 1.5	-
5 + UMA 150D 9/21	69.0	9.3	29 (23)		21.0	77.5	0.83	4 x 2.5	3/4 x 2.5
6 + UMA 150D 13/21	84.0	11.5	33 (28)		26.5	80.5	0.79	4 x 2.5	3/4 x 2.5
7 + UMA 150D 13/21	97.0	13.0	28 (22)		29.0	80.0	0.81	4 x 2.5	3/4 x 2.5
8 + UMA 150D 15/21	111.0	15.0	31 (25)		32.5	81.5	0.83	4 x 4.0	3/4 x 2.5
9 + UMA 150D 18/21	125.0	17.5	30 (24)		39.0	82.0	0.80	4 x 4.0	3/4 x 2.5
10 + UMA 150D 22/21	140.0	20.0	34 (29)		44.0	83.5	0.79	4 x 4.0	3/4 x 2.5
11 + UMA 150D 22/21	153.0	21.0	31 (25)		46.0	83.5	0.80	4 x 4.0	3/4 x 2.5
12 + UMA 150D 26/21	168.0	23.0	36 (31)		49.5	85.0	0.79	4 x 6.0	3/4 x 4.0
13 + UMA 150D 26/21	181.0	25.0	34 (28)		53.0	85.0	0.81	4 x 6.0	3/4 x 4.0

¹⁾ also see page 36

²⁾ 3/4 = 1 x 3-core + 1 x 4-core, 90° spacing.

Dimensions / Weights / Horizontal Installation ¹⁾

UPA 150C - 60 / ...	L _P ≈ mm		L _A ≈ mm		m _A ≈ kg		D _{max} ≈ mm			Installation ²⁾
	for motor		incl. motor		incl. motor		d.o.l.	d.o.l.	Y-Δ	
	DN	UMA	DN	UMA	DN	UMA	DN	UMA	UMA	
1	406	--	765	--	22.9	--	139	--	--	v + h
2	519	--	1075	--	36.5	--	139	--	--	v + h
3	632	664	1406	1385	46.8	65.2	139	143	146	v + h
4	745	777	1519	1495	49.1	67.5	139	143	146	v + h
5	--	890	--	1640	--	72.8	--	143	146	v + h
6	--	1003	--	1830	--	82.0	--	143	146	v + h
7	--	1116	--	1945	--	84.3	--	143	146	v + h
8	--	1229	--	2105	--	90.6	--	145	146	v + h
9	--	1342	--	2260	--	96.8	--	145	146	v + h
10	--	1455	--	2465	--	107.1	--	145	146	v + h
11	--	1568	--	2575	--	109.4	--	145	146	v + h
12	--	1681	--	2795	--	120.6	--	146	147	v + h
13	--	1794	--	2910	--	122.9	--	146	147	v + h

¹⁾ Including check valve with threaded end and standard motor leads.

²⁾ v = vertical / h = horizontal.

UPA 150C - 60 / ..., number of stages 1 - 13

The characteristic curves shown are for preliminary selection only. Exact selection data will be provided in our quotation.

Selection

The pressure losses H_v in the check valve are not considered in the pump characteristic curves.

Legend ...

H_v : Head losses in the check valve

η_p : Pump efficiency (not considering check valve)

NPSH: Net positive suction head required by the pump

Pump End G 3"

The information given below is based on the model with check valve and threaded end.

The changes in the main dimensions resulting from different threaded or flanged ends are specified in the table below.

	Overall length (mm)	D_{max} (mm)
G 3"	48	see page 52
G 4"	93	

Threaded end to DIN ISO 228, Part 1.
Flanged end to DIN 2501, Part 1

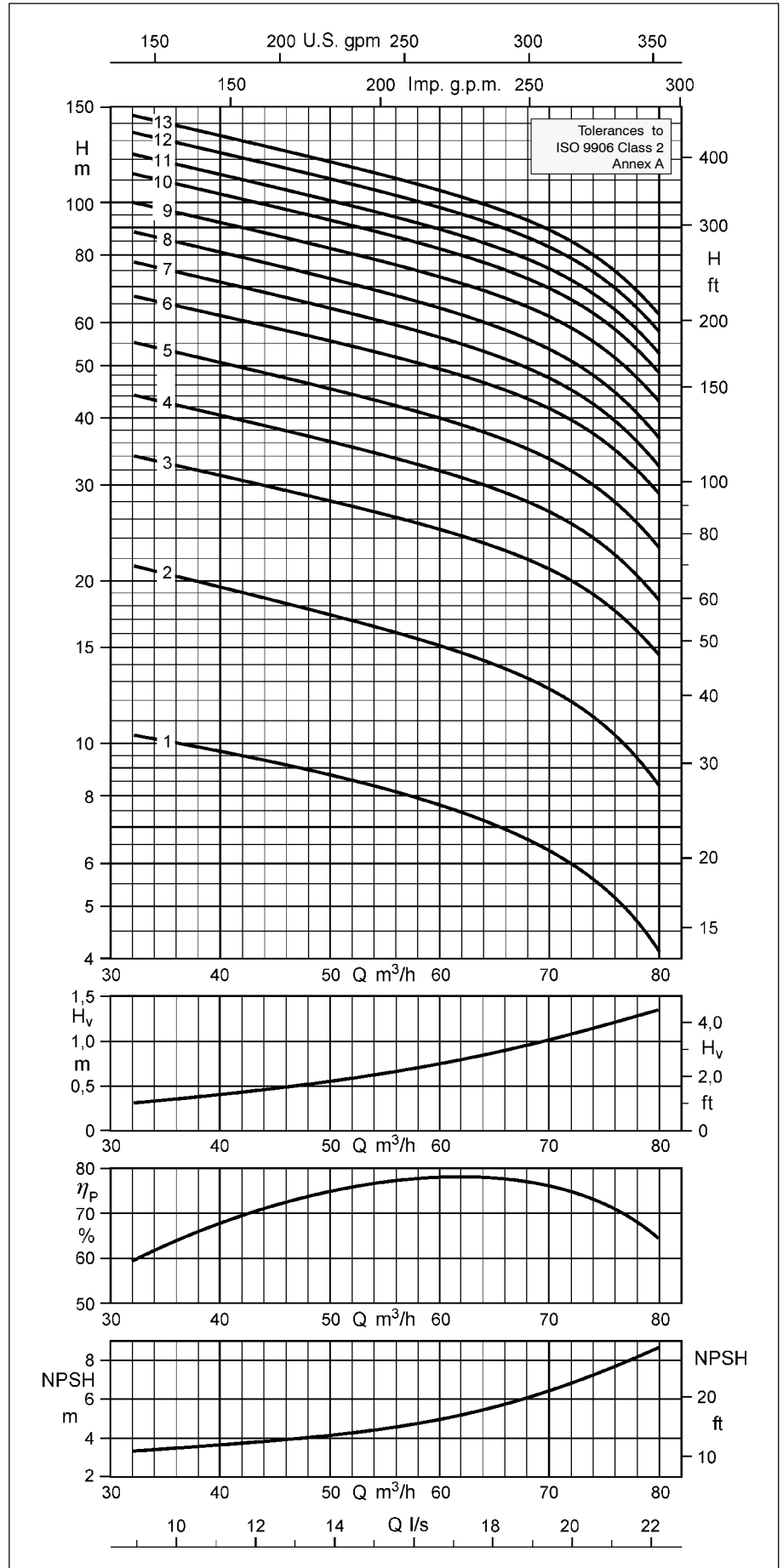
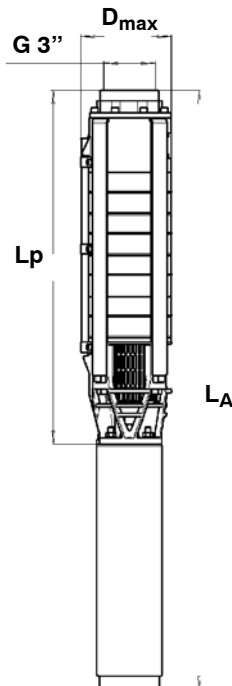

UPA 150C - 60 for Well Diameters of 150 mm (6 inches) and above

Pumps with submersible motors for ... - Type of current / voltage **three-phase (3 ~) / 400 V**
 - Starting **d.o.l. (D) or star-delta (Y-Δ)**

UPA 150C - 60 / ...	Pump		Motor				Motor lead ²⁾ , flat	
	Discharge head Q = 0 m ³ /h H₀ m	Rated power P_N kW	Max. temperature of the fluid pumped v ≥ 0.2 m/s (0.0 m/s) t_{max} ¹⁾ °C	Rated current I_N A	Efficiency η_M %	Power factor cos φ ---	Number x cross-section of conductors (use under water, 400 V and ≤ +30 °C) d.o.l. mm ²	Y-Δ mm ²
14 + UMA 150D 26/21	194.0	26.0	31 (25)	55.0	84.5	0.82	4 x 6.0	3/4 x 4.0
15 + UMA 150D 30/21	210.0	29.0	32 (27)	63.0	84.5	0.80	4 x 6.0	3/4 x 4.0
16 + UMA 150D 30/21	223.0	30.0	30 (24)	65.0	84.5	0.80	4 x 6.0	3/4 x 4.0
17 + UMA 150D 37/22	237.0	33.0	44 (39)	72.0	84.0	0.79	3/4 x 4.0 ³⁾	3/4 x 4.0
18 + UMA 150D 37/22	251.0	35.0	43 (37)	76.0	84.0	0.80	3/4 x 4.0 ³⁾	3/4 x 4.0
19 + UMA 150D 37/22	264.0	36.0	41 (35)	77.0	83.5	0.81	3/4 x 4.0 ³⁾	3/4 x 4.0
20 + UMA 150D 37/22	277.0	37.0	39 (32)	79.0	83.5	0.82	3/4 x 4.0 ³⁾	3/4 x 4.0

¹⁾ also see page 36 ²⁾ 3/4 = 1 x 3-core + 1 x 4-core, 90° spacing. ³⁾ Parallel cable

Dimensions / Weights / Horizontal Installation ¹⁾

UPA 150C - 60 / ...	L _P ≈ mm	L _A ≈ mm	m _A ≈ kg	D _{max} ≈ mm		Installation ²⁾
	for motor	incl. motor	incl. motor	d.o.l.	Y-Δ	
	UMA	UMA	UMA	UMA	UMA	
14	1907	3020	125.0	146	147	v ³⁾
15	2020	3235	136.0	146	147	v ³⁾
16	2133	3345	139.0	146	147	v ³⁾
17	2246	3540	148.0	145	147	v ³⁾
18	2359	3655	150.0	145	147	v ³⁾
19	2472	3765	153.0	145	147	v ³⁾
20	2585	3880	155.0	145	147	v ³⁾

¹⁾ Including check valve with threaded end and standard motor leads. ²⁾ v = vertical / h = horizontal. ³⁾ Horizontal installation on request

UPA 150C - 60 / ..., number of stages 14 - 20

The characteristic curves shown are for preliminary selection only. Exact selection data will be provided in our quotation.

Selection

The pressure losses H_v in the check valve are not considered in the pump characteristic curves.

Legend ...

H_v : Head losses in the check valve

η_p : Pump efficiency (not considering check valve)

NPSH: Net positive suction head required by the pump

Pump End G 3"

The information given below is based on the model with check valve and threaded end.

The changes in the main dimensions resulting from different threaded or flanged ends are specified in the table below.

	Overall length (mm)	D_{max} (mm)
G 3"	48	see page 54
G 4"	93	

Threaded end to DIN ISO 228, Part 1.
Flanged end to DIN 2501, Part 1

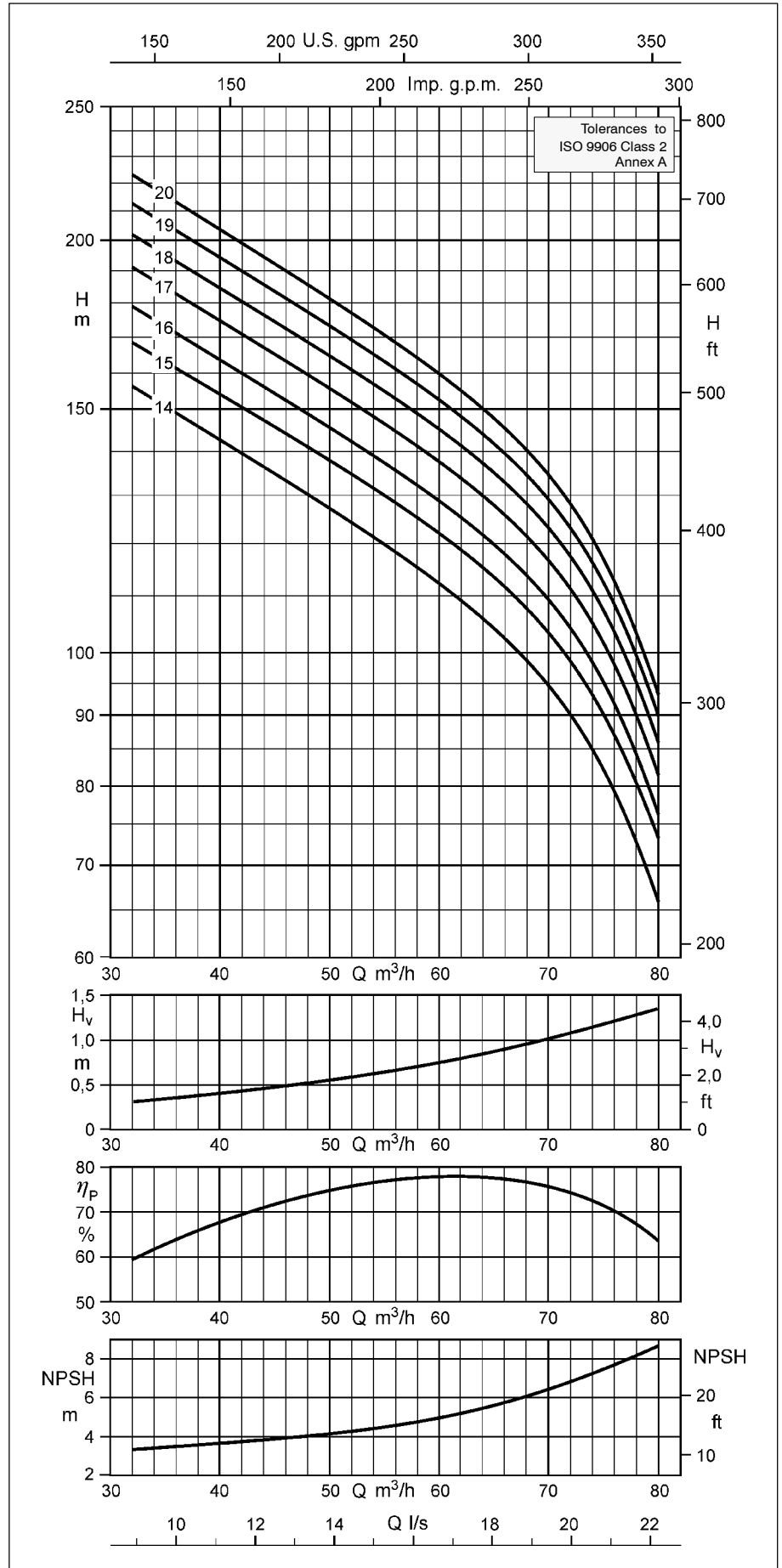
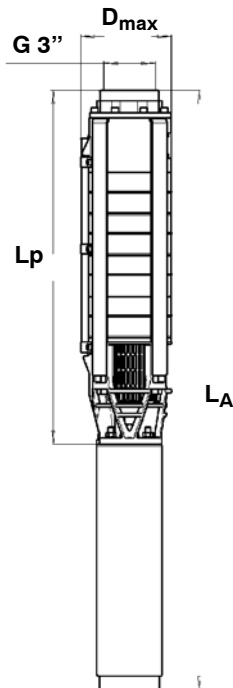

Applications

Handling clean or slightly contaminated water ...

- in general water supply systems,
- in irrigation and spray irrigation systems,
- in pressure boosting systems,
- in emergency water supply systems,
- in installations for lowering and maintaining ground water levels.

Also used in ...

- mining,
- sprinkler installations,
- fountains, etc.

Permissible sand content in the fluid handled: 50 g/m³.

Also suitable for aggressive seawater if supplied in material variant C3 (duplex).

Operating Data

Capacity	Q up to 330 m ³ /h (92 l/s)
Head	H up to 460 m
Temperature of fluid handled	t up to +50 °C
Speed	n ≈ 2900 rpm

Design

Single or multistage, single-entry centrifugal pumps in ring-section design. Mixed flow hydraulic systems with impellers that can be turned down. Stage casings connected by means of studs. Suction casing fitted between pump and motor. Suction casing equipped with strainer to protect the pump from coarse particles in the fluid.

Pumps with non-return valve or connection branch on option. Both models available with either threaded or flanged end. Particularly suitable for vertical installation in narrow deep wells.

Designation (Example)

UPA 200 B - 80 B / 5 d

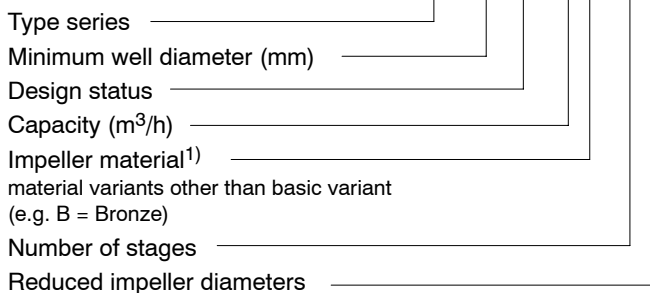

¹⁾ Applies to UPA 200B only.

Certification

Quality management certified to ISO 9001

Submersible Borehole Pumps for Well Diameters of 200 mm (8 inches) and of 250 mm (10 inches)



Product Features

- Very sturdy design
- Suitable for installation in narrow deep wells
- High efficiency
- Motor designed for maximum pump output
- Low noise level
- For vertical or horizontal installation
- Check valve protected against blocking
- Pre-filled motor; no risk of contamination of the pumped water

Selection Chart (Ranges on Offer)

n ≈ 2900 rpm

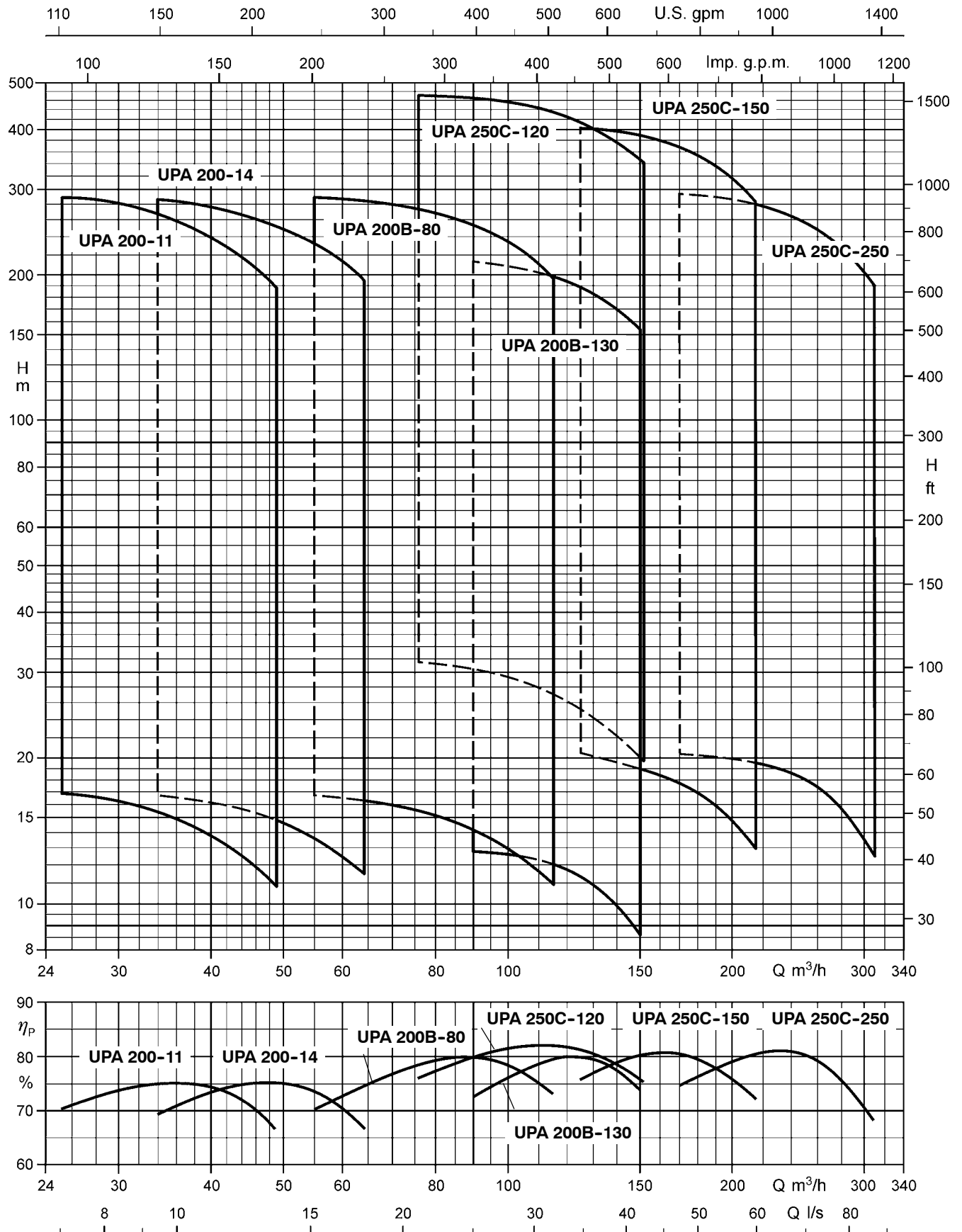

Note:

The diagram shows the ΔQ_A range on offer. The pumps can be offered for any duty point within this range. The ΔQ_B operating ranges of the individual pump sizes are given in the characteristic curves for different stage numbers on the following pages.

Selection charts or performance curves for UPA in material variant C3 (duplex) on request only.

UPA 200 - 11 / ..

The characteristic curves shown are for preliminary selection only. Exact selection data will be provided in our quotation.

Selection

The pressure losses H_v in the check valve are not considered in the pump characteristic curves. For more details and a selection example refer to page 8.

Legend ...

- H_v : Head losses in the check valve
- η_p : Pump efficiency (not considering check valve)
- NPSH: Net positive suction head required by the pump

Pump End G 3" / DN 80

The information is based on the model "with check valve / connection branch and threaded end".

The changes in the main dimensions of the "flanged end" model are specified in the table below.

Check valve / connection branch with:

Threaded end G 3"	Flanged end DN 80	
Length mm	Length mm	Outside diameter mm
200	200 (PN 10/16)	200
	200 (PN 25/40)	200

Threaded end to DIN ISO 228, Part 1

Flange mating dimensions to DIN 2501, Part 1

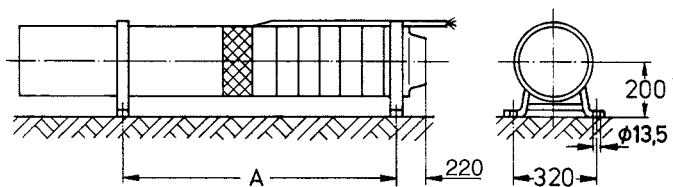
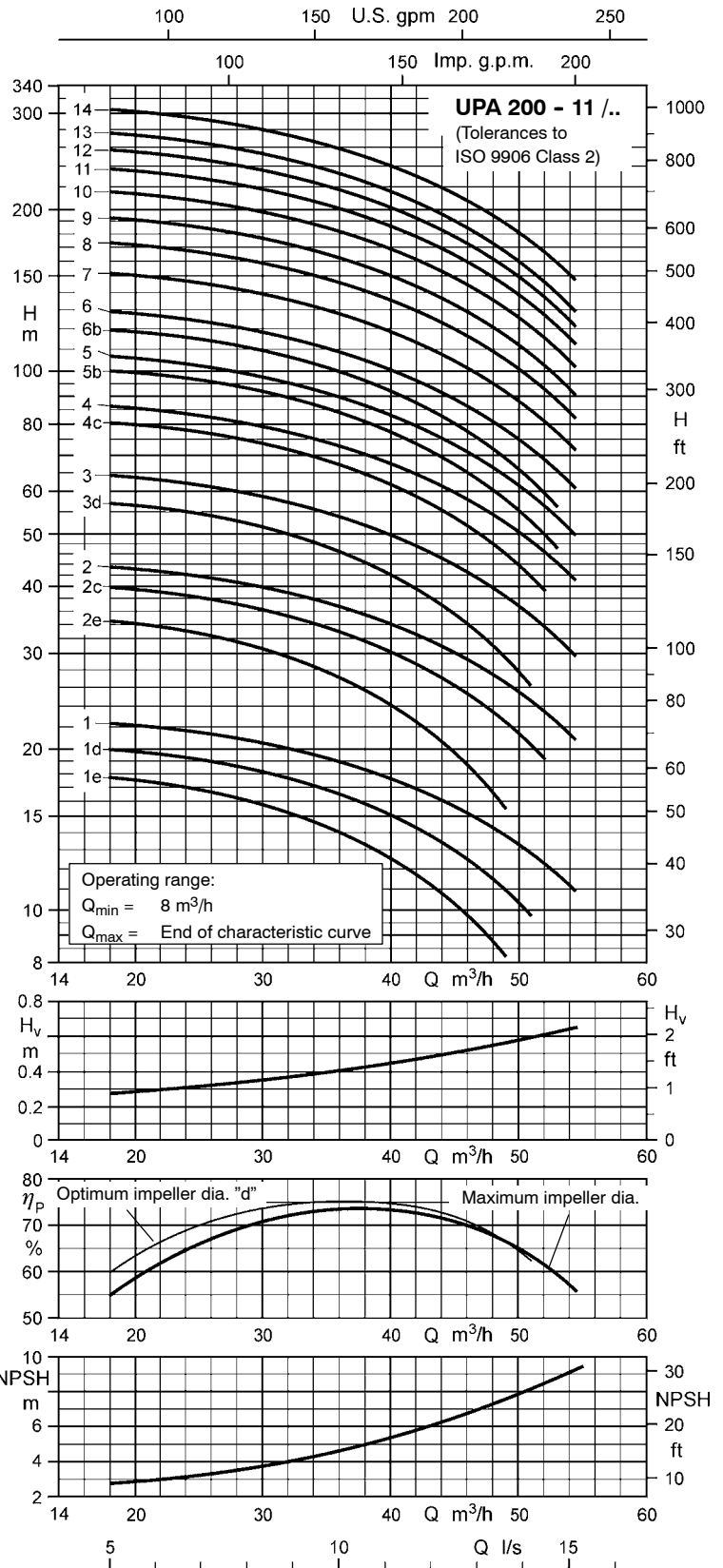
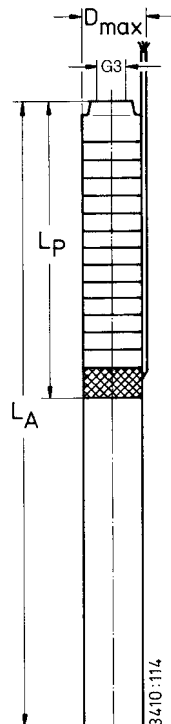

UPA 200 -14 for Well Diameters of 200 mm (8 inches) and above

 Pumps with submersible motors for **three-phase current (3~) / 400 V / d.o.l. (D) or star-delta (Y-Δ) starting**

Pump + motor	Pump	Motor					Motor lead ²⁾ , flat	
	Discharge head Q = 0 m ³ /h H ₀ m	Rated power P _N kW	Max. temperature of the fluid pumped v ≥ 0.2 m/s (= 0 m/s) t _{max} ¹⁾ °C	Rated current I _N A	Efficiency η _M %	Power factor cos φ --	Number x cross-section of conductors (use under water, 400 V and ≤ +30 °C) D.o.l. mm ² Y-Δ mm ²	
UPA 200 - 14/ ... + ...								
1e + UMA 150D 5/21	18	3.0	45 (42)	10.0	73.4	0.62	4 x 2.5	3/4 x 2.5
1d + UMA 150D 5/21	21	3.5	44 (41)	10.6	75.2	0.67	4 x 2.5	3/4 x 2.5
1 + UMA 150D 5/21	25	4.5	42 (39)	12.0	76.4	0.74	4 x 2.5	3/4 x 2.5
2e + UMA 150D 7/21	35	6.0	39 (35)	15.1	77.6	0.77	4 x 2.5	3/4 x 2.5
2d + UMA 150D 7/11	42	7.0	35 (31)	16.8	76.9	0.81	4 x 2.5	3/4 x 2.5
2 + UMA 150D 9/21	50	8.5	34 (29)	20.0	78.3	0.81	4 x 2.5	3/4 x 2.5
3d + UMA 150D 13/21	65	10.5	36 (32)	25.0	80.8	0.76	4 x 2.5	3/4 x 2.5
3 + UMA 150D 13/21	75	12.5	31 (25)	28.0	80.4	0.80	4 x 2.5	3/4 x 2.5
4c + UMA 150D 15/21	90	14.5	32 (27)	31.5	81.9	0.82	4 x 4.0	3/4 x 2.5
4 + UMA 150D 18/21	101	17.0	31 (25)	38.0	82.1	0.79	4 x 4.0	3/4 x 2.5
5c + UMA 150D 18/21	113	18.0	28 (21)	39.5	81.8	0.81	4 x 4.0	3/4 x 2.5
5 + UMA 150D 22/21	126	21.0	31 (26)	46.0	83.5	0.80	4 x 4.0	3/4 x 2.5
6c + UMA 150D 22/21	136	22.0	30 (24)	47.5	83.3	0.81	4 x 4.0	3/4 x 2.5
6 + UMA 150D 26/21	151	25.0	33 (28)	53.0	84.8	0.81	4 x 6.0	3/4 x 4.0
7c + UMA 150D 26/21	159	26.0	33 (28)	55.0	84.6	0.82	4 x 6.0	3/4 x 4.0
7 + UMA 150D 30/21	177	30.0	32 (26)	65.0	84.5	0.80	4 x 6.0	3/4 x 4.0
8 + UMA 150D 37/22	202	34.0	43 (38)	74.0	84.0	0.80	3/4 x 4.0 ⁴⁾	3/4 x 4.0
9 + UMA 150D 37/22	225	37.0	39 (33)	79.0	83.6	0.82	3/4 x 4.0 ⁴⁾	3/4 x 4.0
10 + UMA 200D 45/21	255	44.0	30 (24)	89.0	86.0	0.84	3/4 x 6.0 ³⁾	3/4 x 6.0
11 + UMA 200D 55/21	283	48.0	33 (27)	98.0	87.2	0.82	3/4 x 6.0 ³⁾	3/4 x 6.0
12 + UMA 200D 55/21	307	52.0	30 (24)	104.0	87.1	0.83	3/4 x 6.0 ³⁾	3/4 x 6.0
13 + UMA 200D 55/21	331	55.0	27 (21)	109.0	86.9	0.84	3/4 x 6.0 ³⁾	3/4 x 6.0

1) Also see pages 3 and 60.

2) 3/4 = 1 x 3-core + 1 x 4-core, 90° spacing.

3) Delta wiring in the cable connector or control cabinet.

4) cable parallel

Dimensions / Weights / Horizontal Installation ¹⁾

Pump unit	L _p mm	L _A ≈ mm		m _A ≈ kg		D _{max} ≈ mm		Installation ²⁾	A ≈ mm
		G (Standard)	B (Special)	G (Standard)	B (Special)	D.o.l.	Y-Δ		
UPA 200 - 14/ ..									
1e	530	1230	1240	67	70	192	195	v + h	660
1d	530	1230	1240	67	70	192	195	v + h	660
1	530	1230	1240	67	70	192	195	v + h	660
2e	610	1330	1340	73	77	192	195	v + h	750
2d	610	1330	1340	73	77	192	195	v + h	750
2	610	1360	1370	76	80	192	195	v + h	765
3d	690	1520	1530	87	91	192	195	v + h	885
3	690	1520	1530	87	91	192	195	v + h	885
4c	770	1645	1655	95	100	193	195	v + h	985
4	770	1690	1700	99	104	193	195	v + h	1010
5c	850	1770	1780	106	111	193	195	v + h	1090
5	850	1860	1870	114	119	193	195	v + h	1135
6c	930	1940	1950	117	123	193	195	v + h	1215
6	930	2045	2055	126	132	194	196	v + h	1265
7c	1010	2125	2135	130	136	194	196	v + h	1345
7	1010	2225	2235	139	145	194	196	v + h	1395
8	1090	2385	2395	150	157	196	196	v ³⁾	-
9	1170	2465	2475	151	158	196	196	v ³⁾	-
10	1250	2480	2480	213	221	199	199	v + h	1645
11	1330	2670	2670	237	245	199	199	v + h	1780
12	1410	2750	2750	241	250	199	199	v + h	1860
13	1490	2830	2830	245	254	199	199	v + h	1940

1) Including check valve with threaded end and standard motor leads.

2) v = vertical and h = horizontal.

3) Horizontal installation on request.

UPA 200 - 14 / ..

The characteristic curves shown are for preliminary selection only. Exact selection data will be provided in our quotation.

Selection

The pressure losses H_v in the check valve are not considered in the pump characteristic curves. For more details and a selection example refer to page 8.

Legend ...

- H_v : Head losses in the check valve.
- η_p : Pump efficiency (not considering check valve).
- NPSH: Net positive suction head required by the pump.

Pump End G 3" / DN 80

The information is based on the model "with check valve / connection branch and threaded end.

The changes in the main dimensions of the "flanged end" model are specified in the table below.

Check valve / connection branch with

Threaded end G 3"		Flanged end DN 80	
Length mm	Length mm	Outside diameter mm	
200	200 (PN 10/16) 200 (PN 25/40)	200	

Threaded end to DIN ISO 228, Part 1

Flange mating dimensions to DIN 2501, Part 1

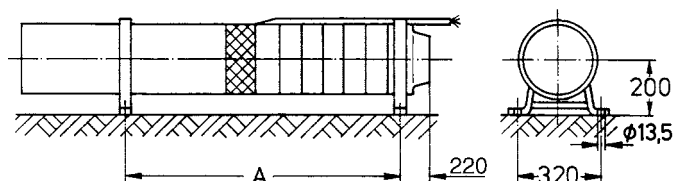
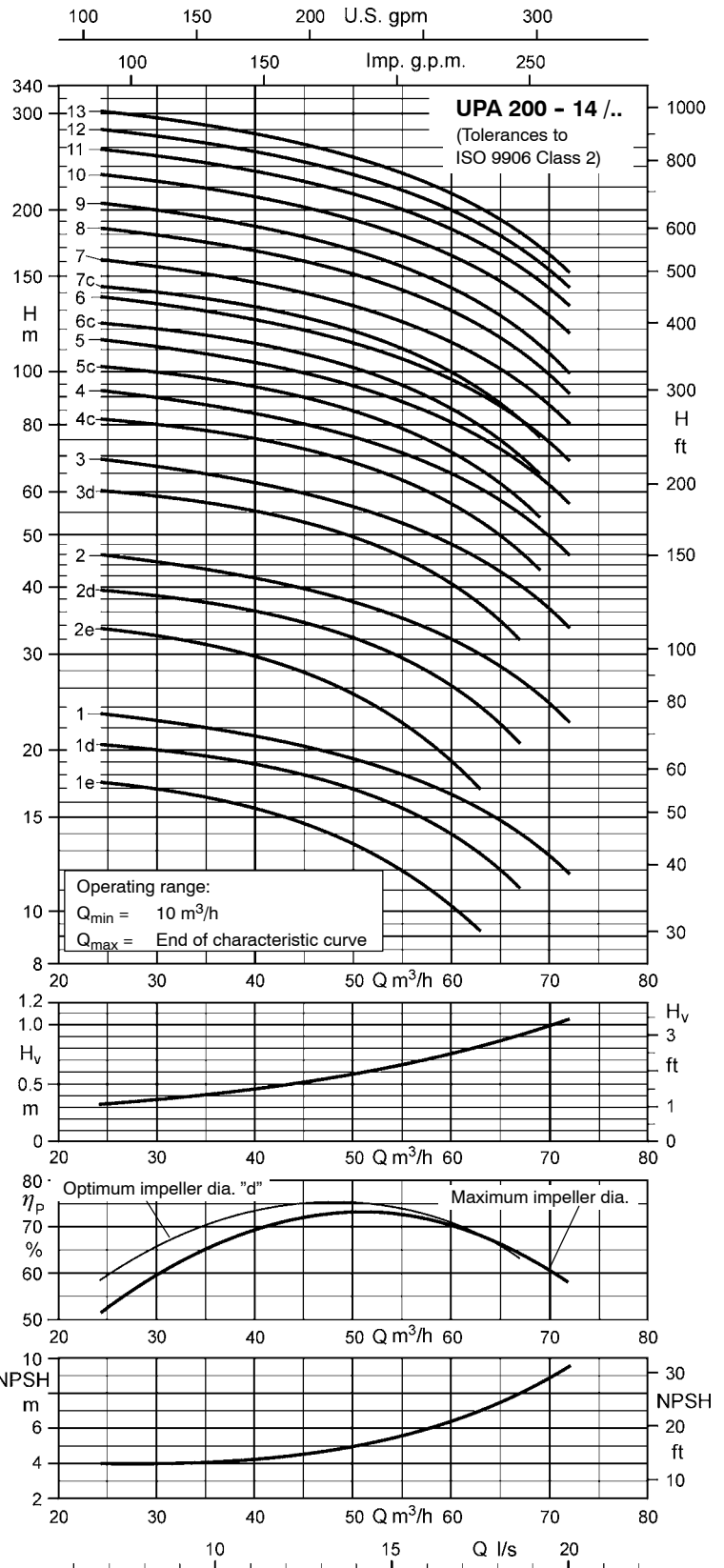
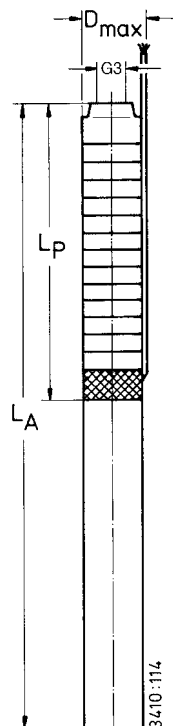

UPA 200B - 80 for Well Diameters of 200 mm (8 inches) and above

 Pumps with submersible motors for **three-phase current (3~) / 400 V / d.o.l. (D) or star-delta (Y-Δ) starting**

Pump + motor	Pump		Motor				Motor lead ²⁾ , flat	
	Discharge head Q = 0 m ³ /h	Rated power	Max. temperature of the fluid pumped v ≥ 0.2 m/s (= 0 m/s)	Rated current	Efficiency	Power factor	Number x cross-section of conductors (use under water, 400 V and ≤ +30 °C)	
UPA 200B - 80/.. + ...	H ₀ m	P _N kW	t _{max} ¹⁾ °C	I _N A	η _M %	cos φ --	D.o.l. mm ²	Y-Δ mm ²
1g + UMA 150D 5/21	20	5.5	37 (33)	13.6	75.7	0.80	4 x 2.5	3/4 x 2.5
1f + UMA 150D 7/21	24	6.0	38 (34)	15.1	77.6	0.77	4 x 2.5	3/4 x 2.5
1d + UMA 150D 7/21	25	7.5	33 (28)	17.8	76.4	0.82	4 x 2.5	3/4 x 2.5
1 + UMA 150D 9/21	27	8.0	34 (30)	19.0	78.6	0.80	4 x 2.5	3/4 x 2.5
2g + UMA 150D 13/21	39	10.5	37 (33)	25.0	80.8	0.76	4 x 2.5	3/4 x 2.5
2f + UMA 150D 13/21	44	12.0	33 (27)	27.0	80.5	0.80	4 x 2.5	3/4 x 2.5
2d + UMA 150D 15/21	48	14.5	33 (28)	31.5	81.9	0.82	4 x 4.0	3/4 x 2.5
2 + UMA 150D 18/21	53	16.0	32 (26)	36.5	82.3	0.78	4 x 4.0	3/4 x 2.5
3f + UMA 150D 18/21	67	16.0	32 (26)	36.5	82.3	0.78	4 x 4.0	3/4 x 2.5
3e + UMA 150D 18/21	70	18.0	28 (22)	39.5	81.8	0.81	4 x 4.0	3/4 x 2.5
3d + UMA 150D 22/21	73	20.0	33 (28)	44.0	83.6	0.79	4 x 4.0	3/4 x 2.5
3 + UMA 150D 22/21	78	22.0	29 (22)	47.5	83.3	0.81	4 x 4.0	3/4 x 2.5
4e + UMA 150D 26/21	94	24.0	35 (30)	52.0	84.9	0.80	4 x 6.0	3/4 x 4.0
4c + UMA 150D 30/21	99	28.0	33 (28)	61.0	84.7	0.79	4 x 6.0	3/4 x 4.0
4 + UMA 150D 30/21	104	30.0	31 (25)	65.0	84.5	0.80	4 x 6.0	3/4 x 4.0
5d + UMA 150D 37/22	122	33.0	44 (39)	72.0	84.1	0.79	3/4 x 4.0 ⁴⁾	3/4 x 4.0
5 + UMA 150D 37/22	129	37.0	39 (33)	79.0	83.6	0.82	3/4 x 4.0 ⁴⁾	3/4 x 4.0
6c + UMA 200D 45/21	150	44.0	30 (24)	89.0	86.0	0.84	3/4 x 6.0 ³⁾	3/4 x 6.0
6 + UMA 200D 45/21	158	45.0	27 (20)	90.0	86.0	0.84	3/4 x 6.0 ³⁾	3/4 x 6.0
7c + UMA 200D 55/21	176	50.0	31 (25)	101.0	87.2	0.83	3/4 x 6.0 ³⁾	3/4 x 6.0
7 + UMA 200D 55/21	185	54.0	28 (22)	108.0	87.0	0.84	3/4 x 6.0 ³⁾	3/4 x 6.0
8c + UMA 200D 55/21	200	55.0	26 (20)	190.0	86.9	0.84	3/4 x 6.0 ³⁾	3/4 x 6.0
8 + UMA 200D 65/21	213	62.0	30 (23)	123.0	87.7	0.83	3/4 x 10 ³⁾	3/4 x 10
9 + UMA 200D 75/21	239	70.0	27 (20)	143.0	87.4	0.81	3/4 x 10 ³⁾	3/4 x 10
10 + UMA 200D 75/21	264	75.0	22 (15)	151.0	87.3	0.83	3/4 x 10 ³⁾	3/4 x 10
11 + UMA 200D 90/21	292	86.0	27 (20)	173.0	88.1	0.82	3/4 x 16 ³⁾	3/4 x 16
12 + UMA 200D 90/21	317	90.0	23 (16)	181.0	88.0	0.82	3/4 x 16 ³⁾	3/4 x 16

1) also see pages 3 and 60.

2) 3/4 = 1 x 3-core + 1 x 4-core, 90° spacing.

3) Delta wiring in the cable connector or control cabinet.

4) Parallel cable

Dimensions / Weights / Horizontal Installation ¹⁾

UPA 200B- 80/..	L _p mm	L _A ≈ mm		m _A ≈ kg		D _{max} ≈ mm		Installation ²⁾	A ≈ mm
		G (Standard)	B (Special)	G (Standard)	B (Special)	D.o.l.	Y-Δ		
1g	582	1280	1295	86	93	193	196	v + h	620
1f	582	1300	1315	88	95	193	196	v + h	630
1d	582	1300	1315	88	95	193	196	v + h	630
1	582	1330	1345	91	98	193	196	v + h	645
2g	714	1545	1555	108	118	193	196	v + h	820
2f	714	1545	1555	108	118	193	196	v + h	820
2d	714	1590	1600	112	122	194	196	v + h	840
2	714	1635	1645	116	126	194	196	v + h	865
3f	846	1765	1780	127	138	194	196	v + h	995
3e	846	1765	1780	127	138	194	196	v + h	995
3d	846	1855	1870	135	146	194	196	v + h	1040
3	846	1855	1870	135	146	194	196	v + h	1040
4e	978	2090	2105	154	168	195	198	v + h	1225
4c	978	2190	2205	163	176	195	198	v + h	1275
4	978	2190	2205	163	176	195	198	v + h	1275
5d	1110	2405	2415	181	195	198	198	v ³⁾	-
5	1110	2405	2415	181	195	198	198	v ³⁾	-
6c	1242	2475	2475	246	264	201	201	v + h	1550
6	1242	2475	2475	246	264	201	201	v + h	1550
7c	1374	2715	2715	277	296	201	201	v + h	1735
7	1374	2715	2715	277	296	201	201	v + h	1735
8c	1506	2845	2845	287	308	201	201	v + h	1865
8	1506	2975	2975	310	331	205	205	v + h	1930
9	1638	3200	3200	337	359	205	205	v ⁴⁾	-
10	1770	3330	3330	347	371	205	205	v ⁴⁾	-
11	1902	3645	3645	390	415	211	211	v ^{3) 4)}	-
12	2034	3775	3775	400	427	211	211	v ^{3) 4)}	-

1) Including check valve with threaded end and standard motor leads.

2) v = vertical and h = horizontal.

3) Horizontal installation on request.

4) Horizontal installation only with bearing pedestals of special design.

UPA 200B - 80 / ..

The characteristic curves shown are for preliminary selection only. Exact selection data will be provided in our quotation.

Selection

The characteristic curves shown apply to the standard impeller material, i.e. Noryl.

The performance data for the full impeller diameter and impeller diameter "b" for the given number of stages will only be achieved when the impellers are made of Noryl (PPO).

For the special impeller material (bronze), please select the next higher number of stages.

In this case, please refer to the characteristic curves individually prepared for the quotation.

The pressure losses H_v in the check valve are not considered in the pump characteristic curves.

For more details and a selection example refer to pages 8.

Legend ...

- H_v : Head losses in the check valve.
- η_p : Pump efficiency (not considering check valve).
- NPSH: Net positive suction head required by the pump.

Pump End G 5" / DN 125

The information is based on the model "with check valve / connection branch and threaded end".

The changes in the main dimensions of the "flanged end" model are specified in the table below.

Check valve / connection branch with

Threaded end G 5"	Flanged end DN 125	
	Length mm	Outside diameter mm
200	150 (PN 10/16) 150 (PN 25/40)	250 270

Threaded end to DIN ISO 228, Part 1.
Flange mating dimensions to DIN 2501, Part 1

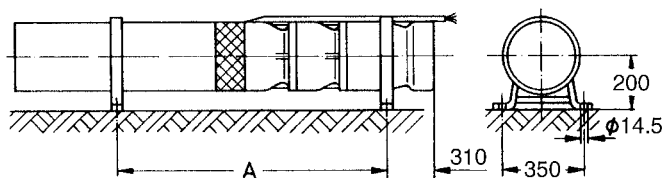
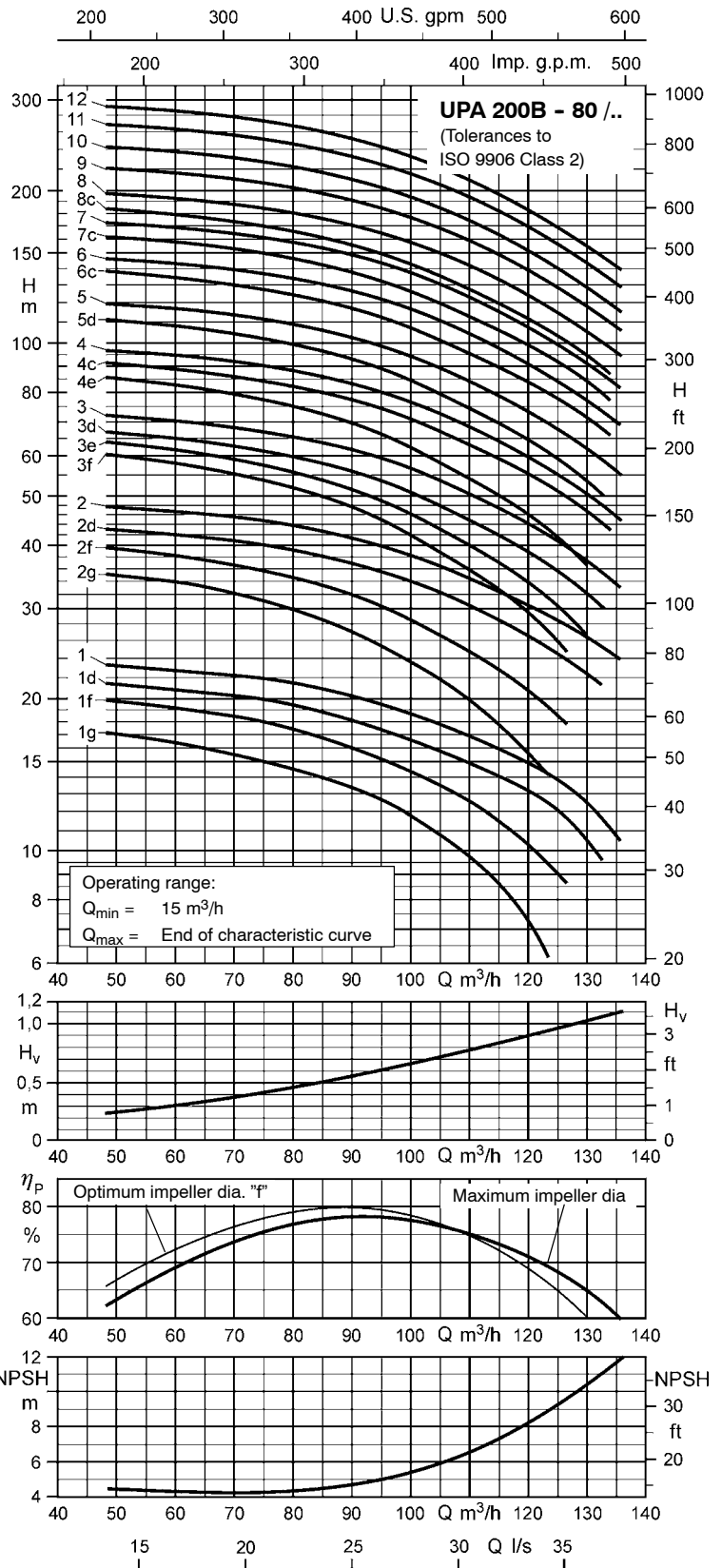
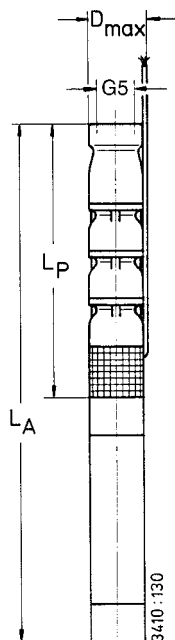

UPA 200B - 130 for Well Diameters of 200 mm (8 inches) and above

Pumps with submersible motors for **three-phase current (3~) / 400 V / d.o.l. (D) or star-delta (Y-Δ) starting**

Pump + motor	Pump		Motor				Motor lead ²⁾ , flat	
	Discharge head Q = 0 m ³ /h	Rated power	Max. temperature of the fluid pumped v ≥ 0.2 m/s (= 0 m/s)	Rated current	Efficiency	Power factor	Number x cross-section of conductors (use under water, 400 V and ≤ +30 °C)	
UPA 200B - 130/.. + ...	H ₀ m	P _N kW	t _{max} ¹⁾ °C	I _N A	η _M %	cos φ --	D.o.l. mm ²	Y-Δ mm ²
1g + UMA 150D 5/21	17	5.5	37 (33)	13.6	75.7	0.80	4 x 2.5	3/4 x 2.5
1e + UMA 150D 7/21	20	6.5	36 (32)	16.0	77.3	0.79	4 x 2.5	3/4 x 2.5
1c + UMA 150D 7/21	23	7.5	31 (25)	17.8	76.4	0.82	4 x 2.5	3/4 x 2.5
1 + UMA 150D 9/21	25	9.0	32 (26)	20.5	77.9	0.82	4 x 2.5	3/4 x 2.5
2g + UMA 150D 13/21	34	11.0	36 (31)	25.5	80.7	0.78	4 x 2.5	3/4 x 2.5
2f + UMA 150D 13/21	37	11.5	33 (28)	26.5	80.6	0.79	4 x 2.5	3/4 x 2.5
2e + UMA 150D 13/21	39	13.0	30 (24)	29.0	80.2	0.81	4 x 2.5	3/4 x 2.5
2d + UMA 150D 15/21	42	14.0	34 (29)	30.5	82.1	0.82	4 x 4.0	3/4 x 2.5
2c + UMA 150D 15/21	44	15.0	31 (26)	32.5	81.7	0.83	4 x 4.0	3/4 x 2.5
2 + UMA 150D 18/21	48	17.0	30 (24)	38.0	82.1	0.79	4 x 4.0	3/4 x 2.5
3e + UMA 150D 18/21	58	18.5	26 (20)	40.5	81.7	0.81	4 x 4.0	3/4 x 2.5
3d + UMA 150D 22/21	63	21.0	32 (27)	46.0	83.5	0.80	4 x 4.0	3/4 x 2.5
3c + UMA 150D 22/21	66	22.0	30 (23)	47.5	83.3	0.81	4 x 4.0	3/4 x 2.5
3b + UMA 150D 26/21	70	24.0	36 (31)	52.0	84.9	0.80	4 x 6.0	3/4 x 4.0
3 + UMA 150D 26/21	72	25.0	33 (28)	53.0	84.8	0.81	4 x 6.0	3/4 x 4.0
4d + UMA 150D 30/21	84	28.0	34 (29)	61.0	84.7	0.79	4 x 6.0	3/4 x 4.0
4c + UMA 150D 30/21	89	30.0	32 (26)	65.0	84.5	0.80	4 x 6.0	3/4 x 4.0
4b + UMA 150D 30/21	92	30.0	30 (24)	65.0	84.5	0.80	4 x 6.0	3/4 x 4.0
4 + UMA 150D 37/22	96	34.0	44 (38)	74.0	84.0	0.80	3/4 x 4.0 ⁴⁾	3/4 x 4.0
5c + UMA 150D 37/22	110	37.0	40 (34)	79.0	83.6	0.82	3/4 x 4.0 ⁴⁾	3/4 x 4.0
5b + UMA 150D 37/22	114	37.0	38 (32)	79.0	83.6	0.82	3/4 x 4.0 ⁴⁾	3/4 x 4.0
5 + UMA 200D 45/21	122	44.0	30 (24)	89.0	86.0	0.84	3/4 x 6.0 ³⁾	3/4 x 6.0
6c + UMA 200D 45/21	135	45.0	28 (21)	90.0	86.0	0.84	3/4 x 6.0 ³⁾	3/4 x 6.0
6b + UMA 200D 55/21	142	48.0	32 (27)	98.0	87.2	0.82	3/4 x 6.0 ³⁾	3/4 x 6.0
6 + UMA 200D 55/21	146	52.0	30 (24)	104.0	87.1	0.83	3/4 x 6.0 ³⁾	3/4 x 6.0
7b + UMA 200D 55/21	164	55.0	27 (21)	109.0	86.9	0.84	3/4 x 6.0 ³⁾	3/4 x 6.0
7 + UMA 200D 65/21	171	60.0	31 (25)	120.0	87.8	0.83	3/4 x 10.0 ³⁾	3/4 x 10.0
8 + UMA 200D 75/21	196	70.0	27 (21)	143.0	87.4	0.81	3/4 x 10.0 ³⁾	3/4 x 10.0
9 + UMA 200D 75/21	219	75.0	23 (15)	151.0	87.3	0.83	3/4 x 10.0 ³⁾	3/4 x 10.0
10 + UMA 200D 90/21	245	86.0	27 (20)	173.0	88.1	0.82	3/4 x 16.0 ³⁾	3/4 x 16.0
11 + UMA 200D 90/21	267	90.0	23 (16)	181.0	88.0	0.82	3/4 x 16.0 ³⁾	3/4 x 16.0

¹⁾ also see pages 3 and 60. ²⁾ 3/4 = 1 x 3-core + 1 x 4-core, 90° spacing. ³⁾ Delta wiring in the cable connector or control cabinet. ⁴⁾ Parallel cable

Dimensions / Weights / Horizontal Installation ¹⁾

UPA 200B - 130/..	L _P mm	L _A ≈ mm		m _A ≈ kg		D _{max} ≈ mm		Installation ²⁾	A ≈ mm
		G (Standard)	B (Special)	G (Standard)	B (Special)	D.o.l.	Y-Δ		
1g	595	1295	1305	86	94	193	196	v + h	625
1e, 1c	595	1315	1325	88	96	193	196	v + h	635
1	595	1345	1355	91	99	193	196	v + h	650
2g, 2f, 2e	740	1570	1580	108	118	193	196	v + h	835
2d, 2c	740	1615	1625	112	122	194	196	v + h	855
2	740	1660	1670	116	126	194	196	v + h	880
3e	885	1805	1815	127	138	194	196	v + h	1025
3d, 3c	885	1895	1905	135	146	194	196	v + h	1070
3b, 3	885	2000	2010	144	156	195	198	v + h	1120
4d, 4c, 4b	1030	2245	2255	163	176	195	198	v + h	1315
4	1030	2325	2335	170	183	198	198	v ³⁾	-
5c, 5b	1175	2470	2480	181	195	198	198	v ³⁾	-
5	1175	2405	2405	236	252	201	201	v + h	1470
6c	1320	2550	2550	246	264	201	201	v + h	1615
6b, 6	1320	2660	2660	266	284	201	201	v + h	1670
7b	1465	2805	2805	277	296	201	201	v + h	1815
7	1465	2935	2935	300	319	205	205	v + h	1880
8	1610	3170	3170	326	347	205	205	v ⁴⁾	-
9	1755	3315	3315	337	359	205	205	v ⁴⁾	-
10	1900	3640	3640	380	403	211	211	v ^{3) 4)}	-
11	2045	3785	3785	390	415	211	211	v ^{3) 4)}	-

¹⁾ Including check valve with threaded end and standard motor leads. ²⁾ v = vertical and h = horizontal.
³⁾ Horizontal installation on request. ⁴⁾ Horizontal installation only with bearing pedestals of special design.

UPA 200B - 130 / ..

The characteristic curves shown are for preliminary selection only. Exact selection data will be provided in our quotation.

Selection

The characteristic curves shown apply to the standard impeller material, i.e. Noryl.

The performance data for the full impeller diameter for the given number of stages will only be achieved when the impellers are made of Noryl (PPO).

For the special impeller material (bronze), please select the next higher number of stages.

In this case, please refer to the characteristic curves individually prepared for the quotation.

The pressure losses H_v in the check valve are not considered in the pump characteristic curves.

For more details and a selection example refer to page 8.

Legend ...

- H_v : Head losses in the check valve
- η_p : Pump efficiency (not considering check valve)
- NPSH: Net positive suction head required by the pump

Pump End G 5" / DN 125

The information is based on the model "with check valve / connection branch and threaded end".

The changes in the main dimensions of the "flanged end" model are specified in the table below.

Check valve / connection branch with:

Threaded end G5"		Flanged end DN 125	
Length mm	Length mm	Outside diameter mm	
200	150 (PN 10/16) 150 (PN 25/40)	250 270	

Threaded end to DIN ISO 228, Part 1

Flange mating dimensions to DIN 2501, Part 1

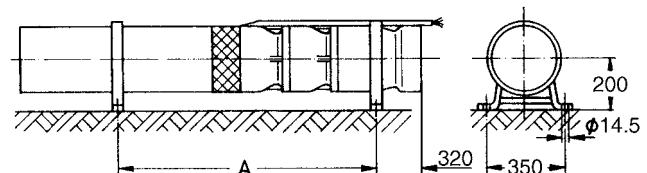
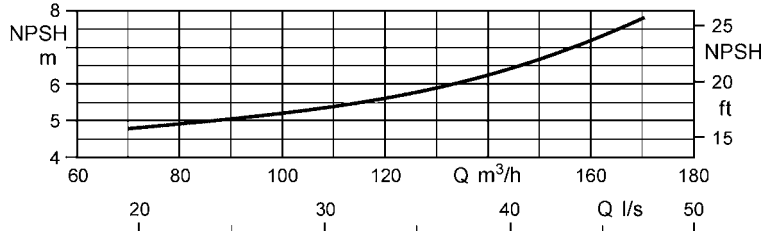
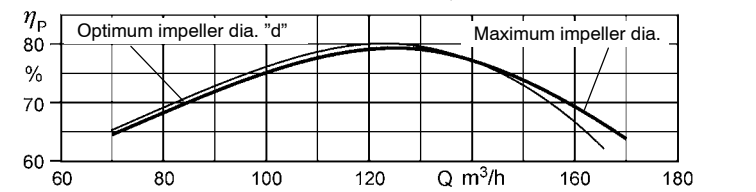
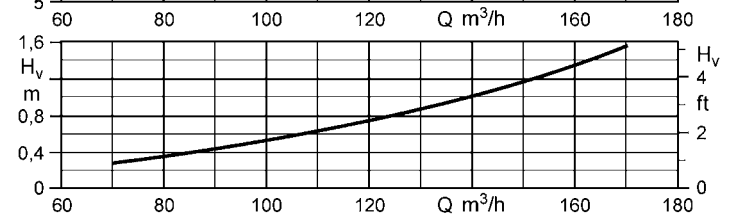
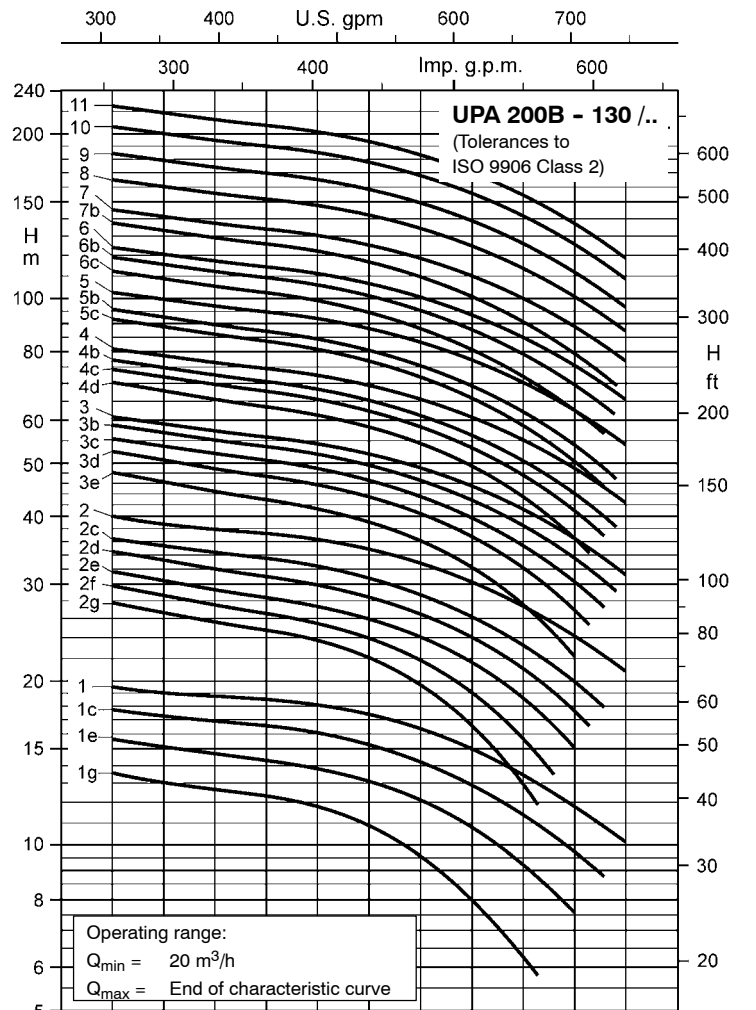
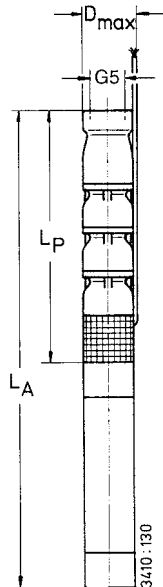

UPA 250C - 120 for Well Diameters of 250 mm (10 inches) and above

Pumps with submersible motors for **three-phase current (3~) / 400 V / d.o.l. (D) or star-delta (Y-Δ) starting**

Pump + motor	Pump		Motor				Motor lead ²⁾ , flat	
	Discharge head Q = 0 m ³ /h	Rated power	Max. temperature of the fluid pumped v ≥ 0.2 m/s (= 0 m/s)	Rated current	Efficiency	Power factor	Number x cross-section of conductors (use under water, 400 V and ≤ +30 °C)	
UPA 250C - 120/.. + ...	H _o m	P _N kW	t _{max} ¹⁾ °C	I _N A	η _M %	cos φ --	D.o.l. mm ²	Y-Δ mm ²
1l + UMA 150D 9/21	29	9.0	31 (26)	20.5	77.9	0.82	4 x 2.5	3/4 x 2.5
1k + UMA 150D 13/21	32	10.5	36 (32)	25.0	80.8	0.76	4 x 2.5	3/4 x 2.5
1g + UMA 150D 13/21	36	12.0	32 (27)	27.0	80.5	0.80	4 x 2.5	3/4 x 2.5
1d + UMA 150D 15/21	40	14.0	33 (28)	30.5	82.1	0.82	4 x 4.0	3/4 x 2.5
1 + UMA 150D 18/21	43	16.5	32 (26)	37.0	82.2	0.79	4 x 4.0	3/4 x 2.5
2l + UMA 150D 18/21	57	18.0	28 (21)	39.5	81.8	0.81	4 x 4.0	3/4 x 2.5
2k + UMA 150D 22/21	62	21.0	32 (26)	46.0	83.5	0.80	4 x 4.0	3/4 x 2.5
2h + UMA 150D 26/21	68	24.0	35 (30)	52.0	84.9	0.80	4 x 6.0	3/4 x 4.0
2f + UMA 150D 26/21	72	26.0	32 (27)	55.0	84.6	0.82	4 x 6.0	3/4 x 4.0
2d + UMA 150D 30/21	79	29.0	32 (26)	63.0	84.6	0.80	4 x 6.0	3/4 x 4.0
2 + UMA 150D 37/22	84	34.0	43 (38)	74.0	84.0	0.80	3/4 x 4.0 ⁴⁾	3/4 x 4.0
3h + UMA 150D 37/22	99	35.0	42 (36)	76.0	83.9	0.80	3/4 x 4.0 ⁴⁾	3/4 x 4.0
3f + UMA 150D 37/22	106	37.0	38 (32)	79.0	83.6	0.82	3/4 x 4.0 ⁴⁾	3/4 x 4.0
3e + UMA 200D 45/21	113	42.0	31 (25)	85.0	86.1	0.83	3/4 x 6.0 ³⁾	3/4 x 6.0
3c + UMA 200D 45/21	122	45.0	27 (20)	90.0	86.0	0.84	3/4 x 6.0 ³⁾	3/4 x 6.0
3 + UMA 200D 55/21	125	52.0	30 (24)	104.0	87.1	0.83	3/4 x 6.0 ³⁾	3/4 x 6.0
4f + UMA 200D 55/21	145	54.0	29 (23)	108.0	87.0	0.84	3/4 x 6.0 ³⁾	3/4 x 6.0
4d + UMA 200D 65/21	158	60.0	31 (25)	120.0	87.8	0.83	3/4 x 10.0 ³⁾	3/4 x 10.0
4 + UMA 200D 75/21	168	70.0	27 (21)	143.0	87.4	0.81	3/4 x 10.0 ³⁾	3/4 x 10.0
5e + UMA 200D 75/21	189	70.0	27 (21)	143.0	87.4	0.81	3/4 x 10.0 ³⁾	3/4 x 10.0
5c + UMA 200D 75/21	203	75.0	22 (14)	151.0	87.3	0.83	3/4 x 10.0 ³⁾	3/4 x 10.0
5 + UMA 200D 90/21	209	86.0	27 (20)	173.0	88.1	0.82	3/4 x 16.0 ³⁾	3/4 x 16.0
6c + UMA 250D 110/21	247	95.0	27 (20)	191.0	88.7	0.81	3/4 x 25.0 ³⁾	3/4 x 25.0
6 + UMA 250D 110/21	251	105.0	23 (15)	208.0	88.6	0.83	3/4 x 25.0 ³⁾	3/4 x 25.0
7 + UMA 250D 132/21	293	120.0	24 (16)	229.0	89.2	0.85	3/4 x 25.0 ³⁾	3/4 x 25.0
8 + UMA 250D 160/21	335	140.0	24 (16)	268.0	89.5	0.85	3/4 x 25.0 ⁴⁾	3/4 x 35.0 ⁵⁾
9 + UMA 250D 190/21	380	155.0	25 (17)	309.0	90.0	0.81	3/4 x 35.0 ⁴⁾ 5)	3/4 x 50.0 ⁵⁾
10 + UMA 250D 190/21	420	175.0	20 (11)	341.0	89.9	0.83	3/4 x 35.0 ⁴⁾ 5)	3/4 x 50.0 ⁵⁾
11 + UMA 300D 250/22	471	195.0	58 (52)	366.0	90.6	0.85	2x3x70 + 1x35 ⁴⁾ 6)	2x3x70 + 1x35 ⁶⁾
12 + UMA 300D 250/22	513	215.0	56 (50)	398.0	90.7	0.86	2x3x70 + 1x35 ⁴⁾ 6)	2x3x70 + 1x35 ⁶⁾

1) also see pages 3 and 60. 3) Delta wiring in the cable connector or control cabinet. 5) 1 x 3-core, flat and 1 x 4-core, round
 2) 3/4 = 1 x 3-core + 1 x 4-core, 90° spacing. 4) Parallel cable 6) 2 x 3-core, flat and 1 x 1-core, round

Dimensions / Weights / Horizontal Installation ¹⁾

UPA 250C - 120/..	L _p mm	L _A ≈ mm		m _A ≈ kg		D _{max} ≈ mm		Installation ²⁾	A ≈ mm
		G (Standard)	B (Special)	G (Standard)	B (Special)	D.o.l.	Y-Δ		
1l	681	1430	1445	115	128	230	232	v + h	710
1k, 1g	681	1510	1525	122	135	230	232	v + h	750
1d	681	1555	1570	126	139	230	232	v + h	775
1	681	1600	1615	130	143	230	232	v + h	795
2l	828	1745	1760	150	167	230	232	v + h	945
2k	828	1835	1850	158	175	230	232	v + h	990
2h, 2f	828	1940	1955	167	185	232	233	v + h	1040
2d	828	2040	2055	176	193	232	233	v + h	1090
2	828	2120	2135	183	200	233	233	v ³⁾	-
3h, 3f	975	2270	2280	203	225	233	233	v ³⁾	-
3e, 3c	975	2205	2205	258	282	235	235	v + h	1245
3	975	2315	2315	278	302	235	235	v + h	1300
4f	1122	2465	2465	298	326	235	235	v + h	1450
4d	1122	2595	2595	321	349	239	239	v + h	1515
4	1122	2685	2685	337	365	239	239	v + h	1560
5e, 5c	1269	2830	2830	357	389	239	239	v + h	1705
5	1269	3010	3010	389	421	244	244	v ³⁾ 4)	-
6c, 6	1416	2945	2945	479	514	257	257	v + h	1835
7	1563	3220	3220	544	583	257	257	v ⁴⁾	-
8	1710	3480	3480	601	644	257	266	v ⁴⁾	-
9	1857	3775	3775	672	719	266	280	v ³⁾ 4)	-
10	2004	3925	3925	692	744	266	280	v ³⁾ 4)	-
11	2151	4225	4225	837	891	304	304	v ⁴⁾	-
12	2298	4370	4370	857	915	304	304	v ⁴⁾	-

1) Including check valve with threaded end and standard motor leads. 2) v = vertical and h = horizontal.
 3) Horizontal installation on request. 4) Horizontal installation only with bearing pedestals of special design.

UPA 250C - 120 / ..

The characteristic curves shown are for preliminary selection only. Exact selection data will be provided in our quotation.

Selection

The pressure losses H_v in the check valve are not considered in the pump characteristic curves.

For more details and a selection example refer to page 8.

Legend ...

- H_v : Head losses in the check valve
- η_p : Pump efficiency (not considering check valve)
- NPSH: Net positive suction head required by the pump

Pump End G 6" / DN 150

The information is based on the model "with check valve / connection branch and threaded end".

The changes in the main dimensions of the "flanged end" model are specified in the table below.

Check valve / connection branch with:

Threaded end G6"	Flanged end DN 150	
	Length mm	Outside diameter mm
229	179 (PN 10/16) 179 (PN 25/40)	285 300

Threaded end to DIN ISO 228, Part 1
Flange mating dimensions to DIN 2501, Part 1

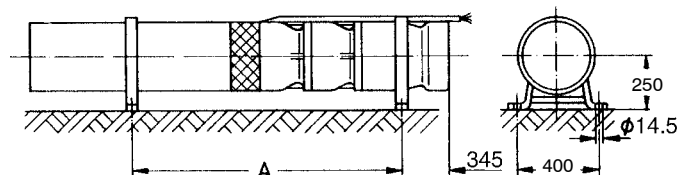
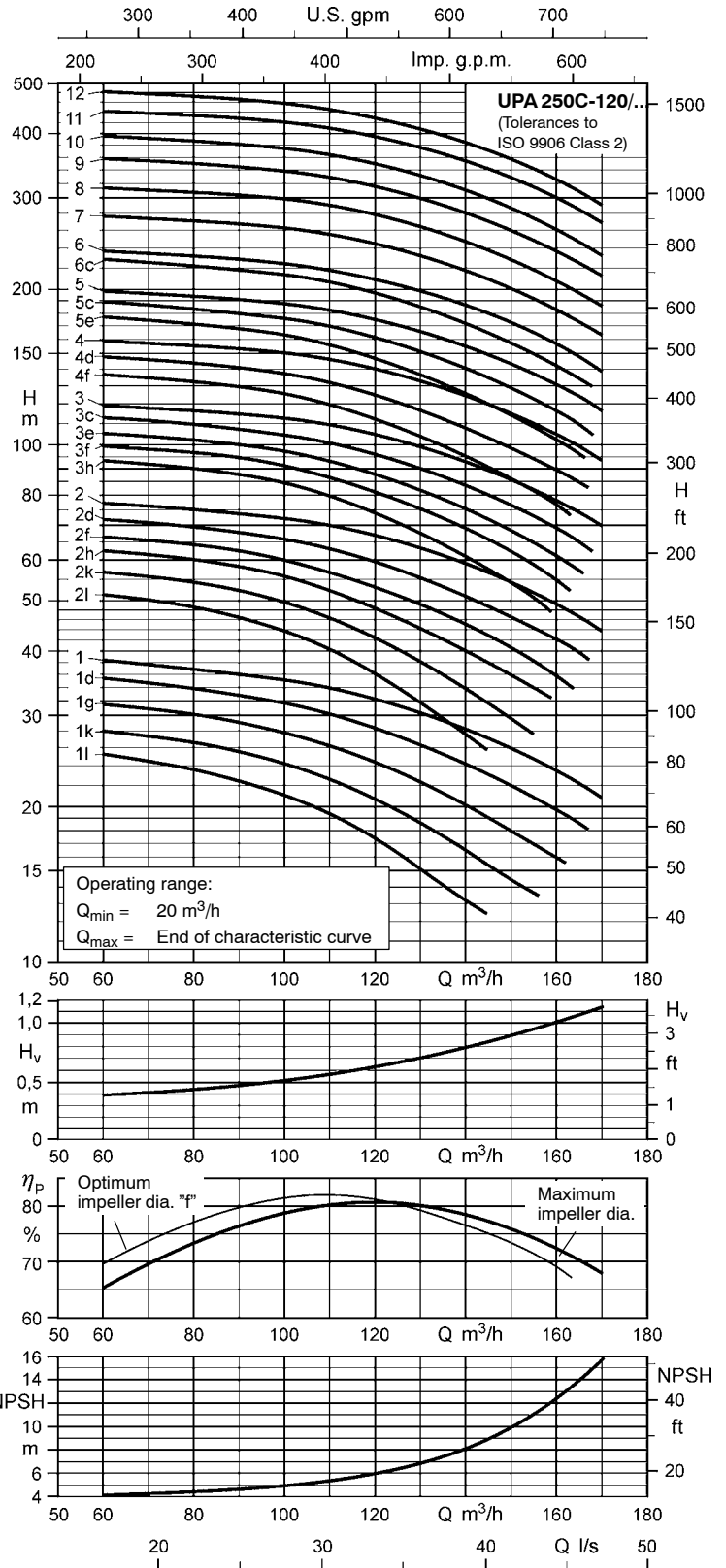
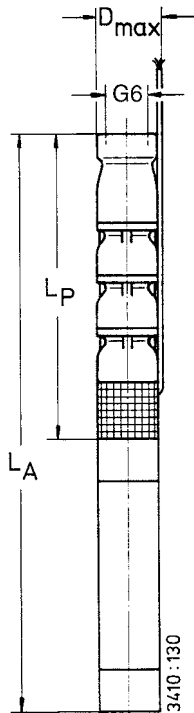

UPA 250C -150 for Well Diameters of 250 mm (10 inches) and above

Pumps with submersible motors for **three-phase current (3~) / 400 V / d.o.l. (D) or star-delta (Y-Δ) starting**

Pump + motor	Pump		Motor				Motor lead ²⁾ , flat	
	Discharge head Q = 0 m ³ /h	Rated power	Max. temperature of the fluid pumped v ≥ 0.2 m/s (= 0 m/s)	Rated current	Efficiency	Power factor	Number x cross-section of conductors (use under water, 400 V and ≤ +30 °C)	
UPA 250C - 150/.. + ...	H ₀ m	P _N kW	t _{max} ¹⁾ °C	I _N A	η _M %	cos φ --	D.o.l. mm ²	Y-Δ mm ²
1l + UMA 150D 13/21	27	11.0	35 (30)	25.5	80.7	0.78	4 x 2.5	3/4 x 2.5
1k + UMA 150D 15/21	32	14.0	34 (29)	30.5	82.1	0.82	4 x 4.0	3/4 x 2.5
1d + UMA 150D 18/21	38	18.5	27 (20)	40.5	81.7	0.81	4 x 4.0	3/4 x 2.5
1 + UMA 150D 22/21	41	22.0	30 (24)	47.5	83.3	0.81	4 x 4.0	3/4 x 2.5
2k + UMA 150D 30/21	64	28.0	34 (28)	61.0	84.7	0.79	4 x 6.0	3/4 x 4.0
2h + UMA 150D 30/21	68	30.0	30 (24)	65.0	84.5	0.80	4 x 6.0	3/4 x 4.0
2f + UMA 150D 37/22	73	34.0	43 (37)	74.0	84.0	0.80	3/4 x 4.0 ⁴⁾	3/4 x 4.0
2c + UMA 150D 37/22	77	37.0	39 (32)	79.0	83.6	0.82	3/4 x 4.0 ⁴⁾	3/4 x 4.0
2 + UMA 200D 45/21	82	44.0	28 (22)	89.0	86.0	0.84	3/4 x 6.0 ³⁾	3/4 x 6.0
3h + UMA 200D 45/21	99	45.0	27 (20)	90.0	86.0	0.84	3/4 x 6.0 ³⁾	3/4 x 6.0
3g + UMA 200D 55/21	105	50.0	31 (25)	101.0	87.2	0.83	3/4 x 6.0 ³⁾	3/4 x 6.0
3d + UMA 200D 55/21	112	55.0	27 (20)	109.0	86.9	0.84	3/4 x 6.0 ³⁾	3/4 x 6.0
3b + UMA 200D 65/21	118	62.0	30 (24)	123.0	87.7	0.83	3/4 x 10.0 ³⁾	3/4 x 10.0
3 + UMA 200D 65/21	121	65.0	27 (20)	129.0	87.7	0.84	3/4 x 10.0 ³⁾	3/4 x 10.0
4e + UMA 200D 75/21	146	72.0	26 (19)	146.0	87.4	0.82	3/4 x 10.0 ³⁾	3/4 x 10.0
4c + UMA 200D 75/21	152	75.0	22 (15)	151.0	87.3	0.83	3/4 x 10.0 ³⁾	3/4 x 10.0
4b + UMA 200D 90/21	158	82.0	28 (21)	167.0	88.2	0.81	3/4 x 16.0 ³⁾	3/4 x 16.0
4 + UMA 200D 90/21	162	88.0	25 (18)	177.0	88.1	0.82	3/4 x 16.0 ³⁾	3/4 x 16.0
5c + UMA 250D 110/21	192	100.0	25 (18)	199.0	88.6	0.82	3/4 x 25.0 ³⁾	3/4 x 25.0
5b + UMA 250D 110/21	197	105.0	23 (15)	208.0	88.6	0.83	3/4 x 25.0 ³⁾	3/4 x 25.0
5 + UMA 250D 110/21	202	110.0	19 (10)	215.0	88.5	0.84	3/4 x 25.0 ³⁾	3/4 x 25.0
6c + UMA 250D 132/21	230	120.0	25 (18)	229.0	89.2	0.85	3/4 x 25.0 ³⁾	3/4 x 25.0
6b + UMA 250D 132/21	236	125.0	23 (14)	237.0	89.1	0.86	3/4 x 25.0 ³⁾	3/4 x 25.0
6 + UMA 250D 132/21	241	132.0	19 (10)	249.0	89.0	0.86	3/4 x 25.0 ³⁾	3/4 x 25.0
7b + UMA 250D 160/21	275	145.0	21 (12)	276.0	89.4	0.85	3/4 x 25.0 ⁴⁾	3/4 x 35.0 ⁵⁾
7 + UMA 250D 190/21	286	160.0	24 (16)	317.0	90.0	0.81	3/4 x 35.0 ^{4) 5)}	3/4 x 50.0 ⁵⁾
8 + UMA 250D 190/21	325	180.0	18 (8)	349.0	89.8	0.83	3/4 x 35.0 ^{4) 5)}	3/4 x 50.0 ⁵⁾
9 + UMA 300D 250/22	373	210.0	57 (51)	389.0	90.7	0.86	2x3x70 + 1x35 ^{4) 6)}	2x3x70 + 1x35 ⁶⁾
10 + UMA 300D 250/22	413	230.0	55 (48)	424.0	90.7	0.87	2x3x70 + 1x35 ^{4) 6)}	2x3x70 + 1x35 ⁶⁾
11 + UMA 300D 250/22	453	250.0	52 (45)	458.0	90.7	0.87	2x3x70 + 1x35 ^{4) 6)}	2x3x70 + 1x35 ⁶⁾

1) also see pages 3 and 60.

2) 3/4 = 1 x 3-core + 1 x 4-core, 90° spacing.

3) Delta wiring in the cable connector or control cabinet.

4) Parallel cable

5) 1 x 3-core, flat and 1 x 4-core, round

6) 2 x 3-core, flat and 1 x 1-core, round

Dimensions / Weights / Horizontal Installation ¹⁾

UPA 250C - 150/..	L _p mm	L _A ≈ mm		m _A ≈ kg		D _{max} ≈ mm		Installation ²⁾	A ≈ mm
		G (Standard)	B (Special)	G (Standard)	B (Special)	D.o.l.	Y-Δ		
1l	690	1520	1530	120	133	230	232	v + h	755
1k	690	1565	1575	124	137	230	232	v + h	775
1d	690	1610	1620	128	141	230	232	v + h	800
1	690	1700	1710	136	149	230	232	v + h	845
2k, 2h	846	2060	2075	173	189	232	233	v + h	1105
2f, 2c	846	2140	2155	180	196	233	233	v ³⁾	-
2	846	2075	2075	235	253	235	235	v + h	1110
3h	1002	2235	2235	254	275	235	235	v + h	1270
3g, 3d	1002	2345	2345	274	295	235	235	v + h	1325
3b, 3	1002	2475	2475	297	318	239	239	v + h	1390
4e, 4c	1158	2720	2720	332	356	239	239	v + h	1590
4b, 4	1158	2900	2900	364	388	244	244	v ³⁾	-
5c, 5b, 5	1314	2845	2845	452	479	257	257	v + h	1730
6c, 6b, 6	1470	3130	3130	515	546	257	257	v ⁴⁾	-
7b	1626	3395	3395	571	605	257	266	v ⁴⁾	-
7	1626	3545	3545	622	656	266	280	v ^{3) 4)}	-
8	1782	3700	3700	641	678	266	280	v ^{3) 4)}	-
9	1938	4010	4010	785	823	304	304	v ⁴⁾	-
10	2094	4165	4165	804	845	304	304	v ⁴⁾	-
11	2250	4325	4325	822	867	304	304	v ⁴⁾	-

1) Including check valve with threaded end and standard motor leads.

2) v = vertical and h = horizontal.

3) Horizontal installation on request.

4) Horizontal installation only with bearing pedestals of special design.

UPA 250C - 150 / ..

The characteristic curves shown are for preliminary selection only. Exact selection data will be provided in our quotation.

Selection

The pressure losses H_v in the check valve are not considered in the pump characteristic curves. For more details and a selection example refer to page 8.

Legend ...

- H_v : Head losses in the check valve
- η_p : Pump efficiency (not considering check valve)
- NPSH: Net positive suction head required by the pump

Pump End G 6" / DN 150

The information is based on the model "with check valve / connection branch and threaded end".

The changes in the main dimensions of the "flanged end" model are specified in the table below.

Check valve / connection branch with:

Threaded end G 6"		Flanged end DN 150	
Length mm	Length mm	Outside diameter mm	
229	179 (PN 10/16)	285	
	179 (PN 25/40)	300	

Threaded end to DIN ISO 228, Part 1.

Flange mating dimensions to DIN 2501, Part 1

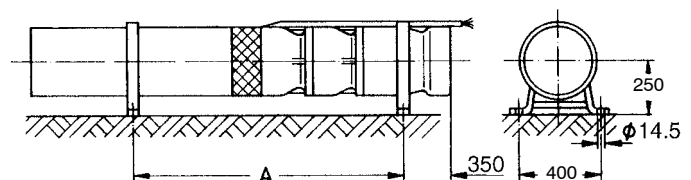
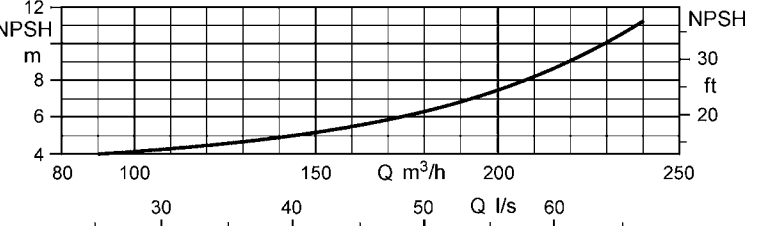
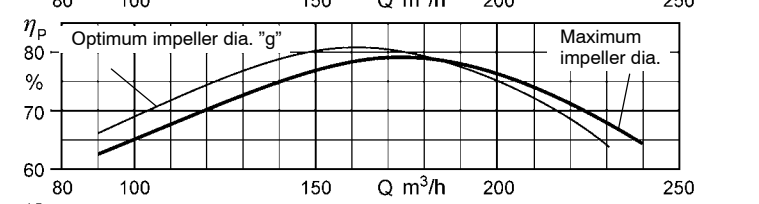
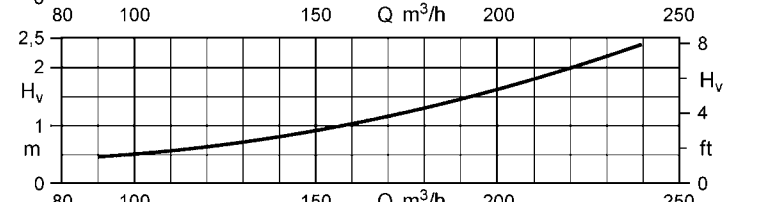
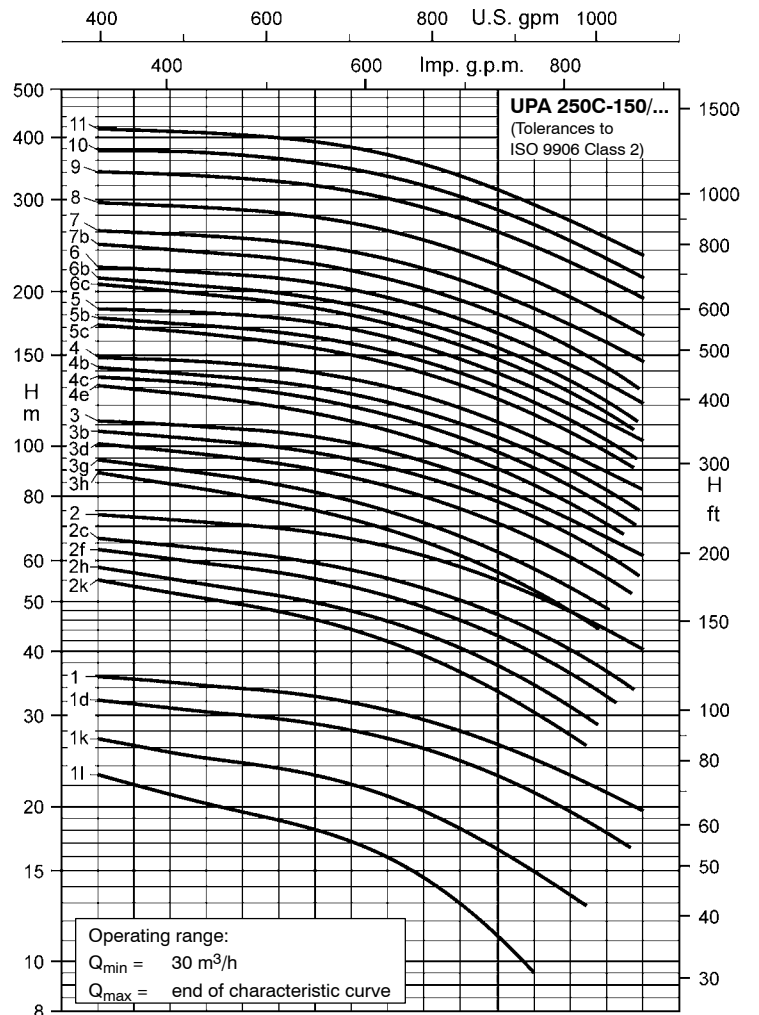
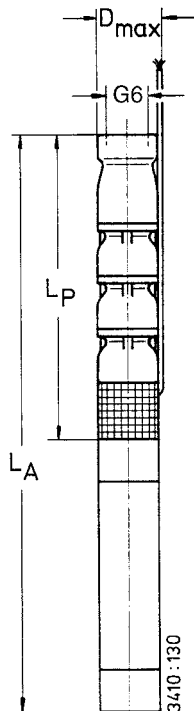

UPA 250C - 250 for Well Diameters of 250 mm (10 inches) and above

Pumps with submersible motors for **three-phase current (3~) / 400 V / d.o.l. (D) or star-delta (Y-Δ) starting**

Pump + motor	Pump		Motor				Motor lead ²⁾ , flat	
	Discharge head Q = 0 m ³ /h	Rated power	Max. temperature of the fluid pumped v ≥ 0.2 m/s (= 0 m/s)	Rated current	Efficiency	Power factor	Number x cross-section of conductors (use under water, 400 V and ≤ +30 °C)	
UPA 250C - 250/.. + ...	H ₀ m	P _N kW	t _{max} ¹⁾ °C	I _N A	η _M %	cos φ --	D.o.l. mm ²	Y-Δ mm ²
1m + UMA 150D 18/21	26	17.0	31 (25)	38.0	82.1	0.79	4 x 4.0	3/4 x 2.5
1k + UMA 150D 18/21	29	18.5	27 (20)	40.5	81.7	0.81	4 x 4.0	3/4 x 2.5
1f + UMA 150D 22/21	32	21.0	32 (26)	46.0	83.5	0.80	4 x 4.0	3/4 x 2.5
1 + UMA 150D 26/21	38	26.0	33 (27)	55.0	84.6	0.82	4 x 6.0	3/4 x 4.0
2m + UMA 150D 37/22	51	33.0	45 (39)	72.0	84.1	0.79	3/4 x 4.0 ⁴⁾	3/4 x 4.0
2l + UMA 150D 37/22	55	35.0	42 (36)	76.0	83.9	0.80	3/4 x 4.0 ⁴⁾	3/4 x 4.0
2g + UMA 150D 37/22	60	37.0	38 (32)	79.0	83.6	0.82	3/4 x 4.0 ⁴⁾	3/4 x 4.0
2d + UMA 200D 45/21	70	45.0	27 (20)	90.0	86.0	0.84	3/4 x 6.0 ³⁾	3/4 x 6.0
2 + UMA 200D 55/21	75	52.0	30 (24)	104.0	87.1	0.83	3/4 x 6.0 ³⁾	3/4 x 6.0
3h + UMA 200D 55/21	87	55.0	27 (20)	109.0	86.9	0.84	3/4 x 6.0 ³⁾	3/4 x 6.0
3f + UMA 200D 65/21	94	62.0	30 (24)	123.0	87.7	0.83	3/4 x 10.0 ³⁾	3/4 x 10.0
3d + UMA 200D 75/21	103	68.0	28 (21)	140.0	87.5	0.81	3/4 x 10.0 ³⁾	3/4 x 10.0
3 + UMA 200D 75/21	109	75.0	24 (16)	151.0	87.3	0.83	3/4 x 10.0 ³⁾	3/4 x 10.0
4g + UMA 200D 75/21	120	75.0	22 (15)	151.0	87.3	0.83	3/4 x 10.0 ³⁾	3/4 x 10.0
4e + UMA 200D 90/21	131	86.0	27 (20)	173.0	88.1	0.82	3/4 x 16.0 ³⁾	3/4 x 16.0
4c + UMA 250D 110/21	142	95.0	26 (19)	191.0	88.7	0.81	3/4 x 25.0 ³⁾	3/4 x 25.0
4 + UMA 250D 110/21	147	105.0	24 (16)	208.0	88.6	0.83	3/4 x 25.0 ³⁾	3/4 x 25.0
5e + UMA 250D 110/21	164	110.0	21 (12)	215.0	88.5	0.84	3/4 x 25.0 ³⁾	3/4 x 25.0
5c + UMA 250D 132/21	176	120.0	25 (17)	229.0	89.2	0.85	3/4 x 25.0 ³⁾	3/4 x 25.0
5 + UMA 250D 132/21	182	125.0	22 (13)	237.0	89.1	0.86	3/4 x 25.0 ³⁾	3/4 x 25.0
6d + UMA 250D 132/21	204	132.0	18 (8)	249.0	89.0	0.86	3/4 x 25.0 ³⁾	3/4 x 25.0
6 + UMA 250D 160/21	218	150.0	19 (9)	284.0	89.3	0.86	3/4 x 25.0 ⁴⁾	3/4 x 35 ⁵⁾
7c + UMA 250D 190/21	248	170.0	22 (13)	333.0	89.9	0.82	3/4 x 35 ⁴⁾ ⁵⁾	3/4 x 50 ⁵⁾
7 + UMA 250D 190/21	256	180.0	19 (9)	349.0	89.8	0.83	3/4 x 35 ⁴⁾ ⁵⁾	3/4 x 50 ⁵⁾
8c + UMA 300D 250/22	288	195.0	58 (52)	366.0	90.6	0.85	2x3x70 + 1x35 ⁴⁾ ⁶⁾	2x3x70 + 1x35 ⁶⁾
8 + UMA 300D 250/22	299	210.0	57 (51)	389.0	90.7	0.86	2x3x70 + 1x35 ⁴⁾ ⁶⁾	2x3x70 + 1x35 ⁶⁾
9 + UMA 300D 250/22	335	235.0	54 (48)	430.0	90.7	0.87	2x3x70 + 1x35 ⁴⁾ ⁶⁾	2x3x70 + 1x35 ⁶⁾
10 + UMA 300D 300/22	374	260.0	56 (50)	482.0	91.2	0.86	6x1x95 + 1x95 ⁴⁾ ⁷⁾	6x1x95 + 1x95 ⁷⁾

¹⁾ also see pages 3 and 60.

³⁾ Delta wiring in the cable connector or control cabinet..

⁵⁾ 1 x 3-core, flat and 1 x 4-core, round

²⁾ 3/4 = 1 x 3-core + 1 x 4-core, 90° spacing.

⁴⁾ Parallel cable

⁶⁾ 2 x 3-core, flat and 1 x 1-core, round

⁷⁾ 7 x 1-core, round

Dimensions / Weights / Horizontal Installation ¹⁾

UPA 250C- 250/..	L _p mm	L _A ≈ mm		m _A ≈ kg		D _{max} ≈ mm		Installation ²⁾	A ≈ mm
		G (Standard)	B (Special)	G (Standard)	B (Special)	D.o.l.	Y-Δ		
1m, 1k	709	1630	1640	128	137	230	232	v + h	800
1f	709	1720	1730	136	145	230	232	v + h	845
1	709	1825	1835	145	155	232	233	v + h	895
2m, 2l, 2g	884	2180	2190	180	192	233	233	v ³⁾	-
2d	884	2115	2115	235	249	235	235	v + h	1130
2	884	2225	2225	255	269	235	235	v + h	1185
3h	1059	2400	2400	274	291	235	235	v + h	1360
3f	1059	2530	2530	297	314	239	239	v + h	1425
3d, 3	1059	2620	2620	313	330	239	239	v + h	1470
4g	1234	2795	2795	332	353	239	239	v + h	1645
4e	1234	2975	2975	364	385	244	244	v ³⁾	-
4c, 4	1234	2765	2765	434	454	257	257	v + h	1630
5e	1409	2940	2940	453	476	257	257	v + h	1805
5c, 5	1409	3070	3070	497	520	257	257	v ⁴⁾	-
6d	1584	3245	3245	516	542	257	257	v ⁴⁾	-
6	1584	3355	3355	553	579	257	266	v ⁴⁾	-
7c, 7	1759	3680	3680	623	652	266	280	v ³⁾ ⁴⁾	-
8c, 8	1934	4005	4005	767	798	304	304	v ⁴⁾	-
9	2109	4180	4180	786	820	304	304	v ⁴⁾	-
10	2284	4535	4535	883	920	282	282	v ⁴⁾	-

¹⁾ Including check valve with threaded end and standard motor leads.

³⁾ Horizontal installation on request.

²⁾ v = vertical and h = horizontal.

⁴⁾ Horizontal installation only with bearing pedestals of special design.

UPA 250C - 250 / ..

The characteristic curves shown are for preliminary selection only. Exact selection data will be provided in our quotation.

Selection

The pressure losses H_v in the check valve are not considered in the pump characteristic curves. For more details and a selection example refer to page 8.

Legend ...

- H_v : Head losses in the check valve.
- η_p : Pump efficiency (not considering check valve)
- NPSH: Net positive suction head required by the pump.

Pump End G 6" / DN 150

The information is based on the model "with check valve / connection branch and threaded end".

The changes in the main dimensions of the "flanged end" model are specified in the table below.

Check valve / connection branch with:

Threaded end G 6"		Flanged end DN 150	
Length mm	Length mm	Outside diameter mm	
229	179 (PN 10/16) 179 (PN 25/40)	285	300

Threaded end to DIN ISO 228, Part 1

Flange mating dimensions to DIN 2501, Part 1

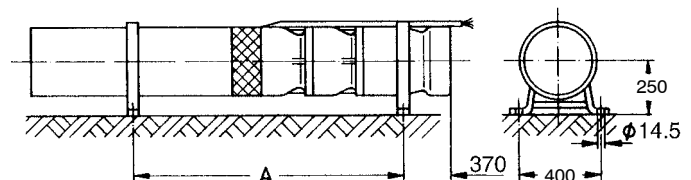
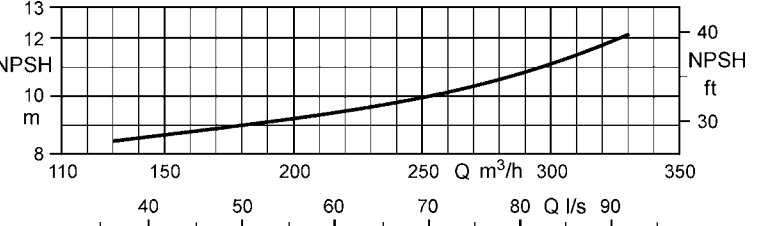
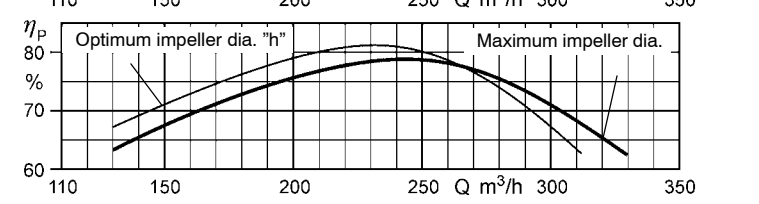
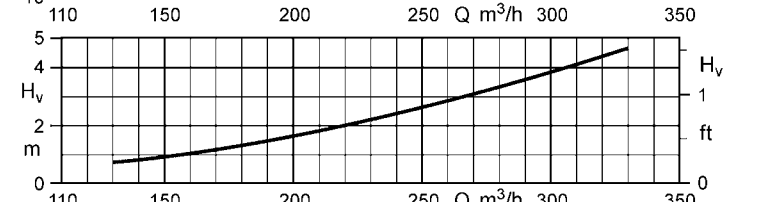
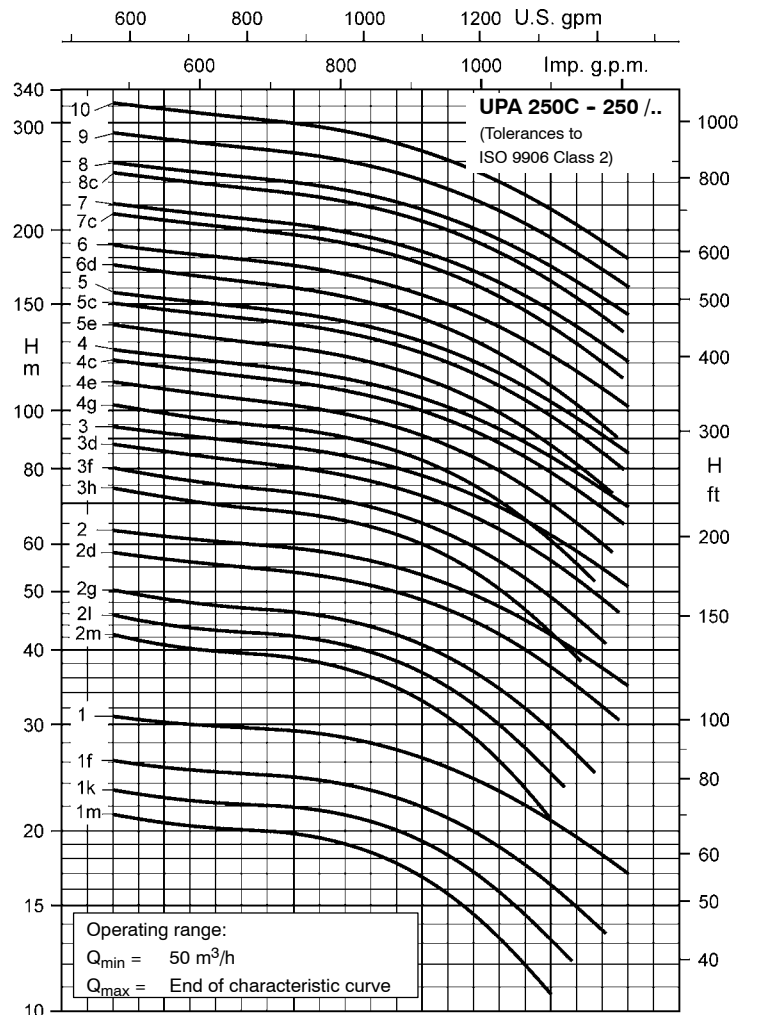
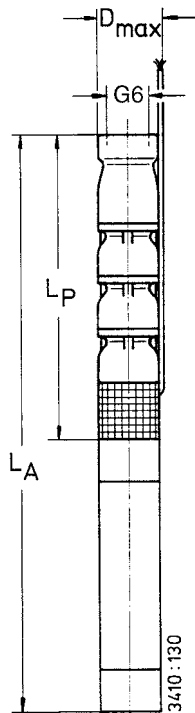

Fields of Application

Handling clean or slightly contaminated water in applications such as:

- general water supply,
- irrigation and spray irrigation,
- pressure boosting,
- lowering and maintaining ground water levels as well as
- drainage.

Also used in mining, sprinkler installations, fountains etc.

Permissible sand content in the fluid handled: 50 g/m³.

Also suitable for aggressive seawater if supplied in material variant C3 (duplex).

Operating Data

Capacity	Q up to 840 m ³ /h (234 l/s)
Head	H up to 480 m
Temperature of fluid handled	t up to +50 °C
Speed	n ≈ 2900 rpm

Design

Single or multistage, single-entry centrifugal pump in ring-section design. For vertical and horizontal installation. Mixed flow hydraulic systems with impellers that can be turned down. Stage casings are connected by means of stud bolts.

Suction casing fitted between pump and motor. Suction casing equipped with strainer to protect the pump from coarse particles in the fluid.

Pumps with check valve or connection branch on option. Both models with threaded or flanged end.

Particularly suitable for vertical installation in narrow deep wells.

Designation (Example)

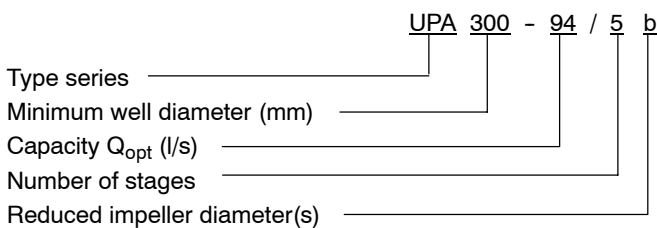

Certification

Quality management certified to ISO 9001

Submersible Borehole Pumps for well diameters of 300 mm (12 inches) and above and of 350 mm (14 inches) and above



Available automation products:

- Hyamaster
 - hyatronic
 - switch gear
- (for UPA 350)

Product Features

- Very sturdy design
- Suitable for installation in narrow deep wells
- High efficiency
- Motor designed for maximum pump output
- Low noise level
- For vertical or horizontal installation
- Check valve protected against blocking
- Pre-filled motor; no risk of contamination of the pumped water

Selection Charts (Ranges on Offer)

$n \approx 2900$ rpm

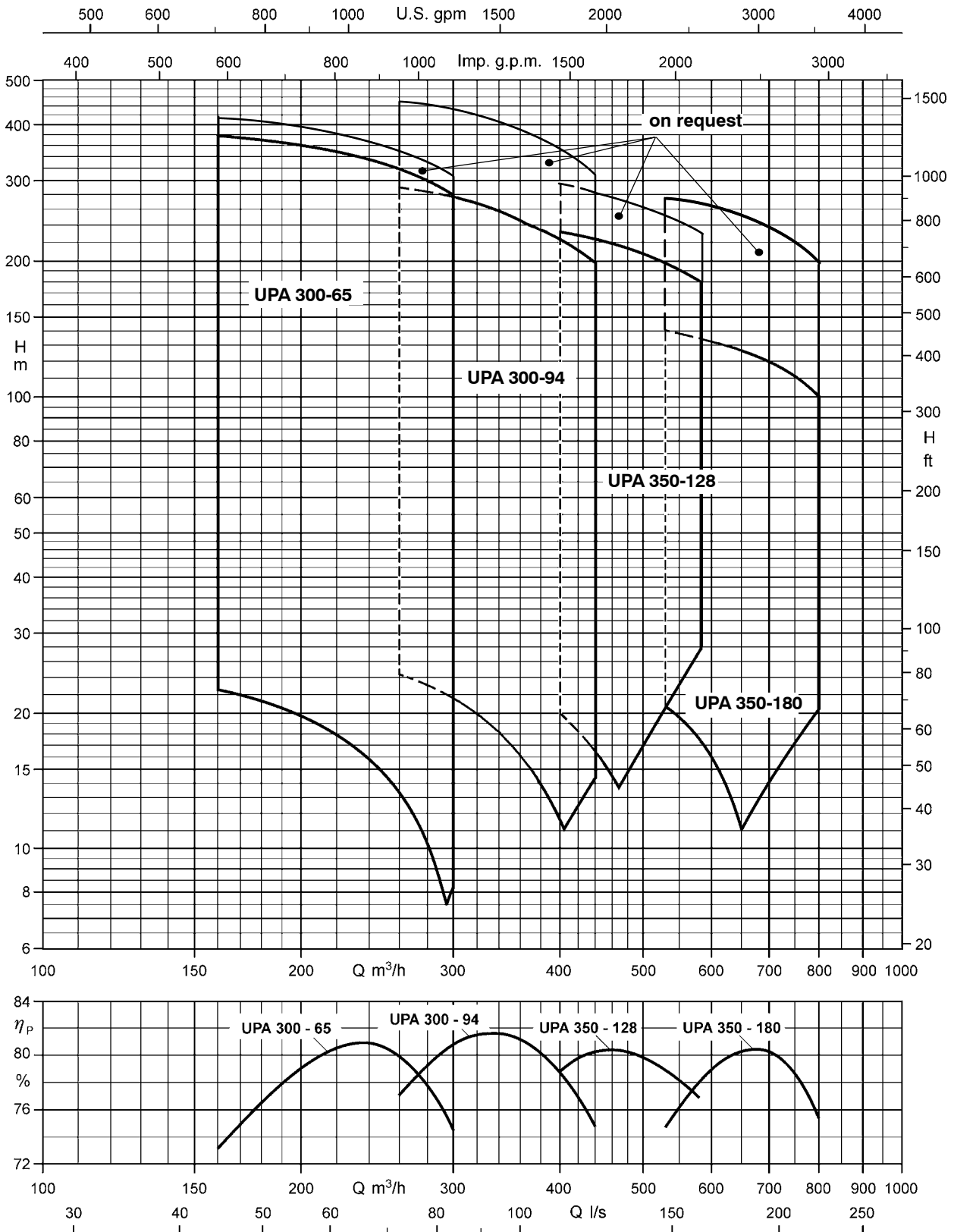

Note: The diagram shows the ΔQ_A range on offer. The pumps can be offered for any duty point within this range. The ΔQ_B operating ranges of the individual pump sizes are given in the characteristic curves for different stage numbers on the following pages. **Selection charts or performance curves for UPA in material variant C3 (duplex) in request only.**

UPA 300 - 65 / ..

The characteristic curves shown are for preliminary selection only. Exact selection data will be provided in our quotation.

Selection

The pressure losses H_v in the check valve are not considered in the pump characteristic curves. For more details and a selection example refer to page 8.

Legend ...

H_v : Head losses in the check valve

η_p : Pump efficiency (not considering check valve)

NPSH: Net positive suction head required by the pump

Pump End G 6" / DN 150

The information is based on the model "with check valve and threaded end".

The changes in the main dimensions of the "flanged end" model or the model "with connection branch" are specified in the table below.

a) Check valve with:

Threaded end G 6"		Flanged end DN 150	
Length mm	Length mm	Outside dia. mm	
255	220 (PN 10/16) 228 (PN 25/40)	285	300

b) Connection branch with:

Threaded end G 6"		Flanged end DN 150	
Length mm	Length mm	Outside dia. mm	
150	140 (PN 10/16) 148 (PN 25/40)	285	300

Threaded end to DIN ISO 228, Part 1.

Flange mating dimensions to DIN 2501, Part 1

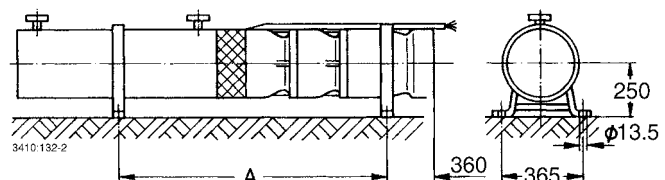
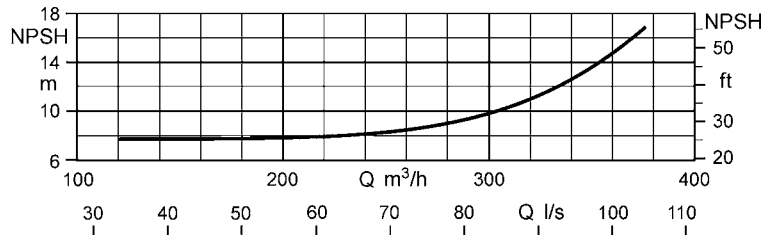
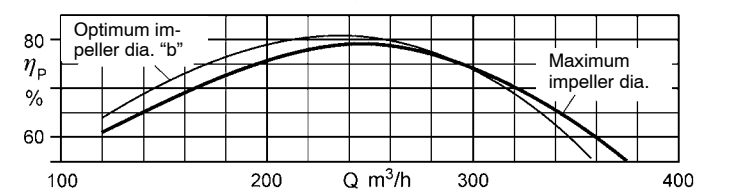
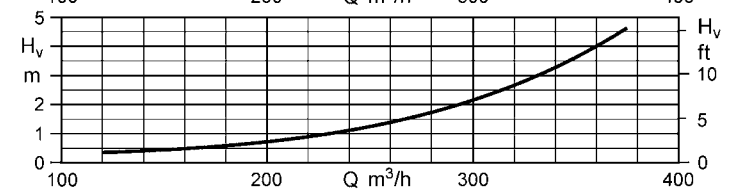
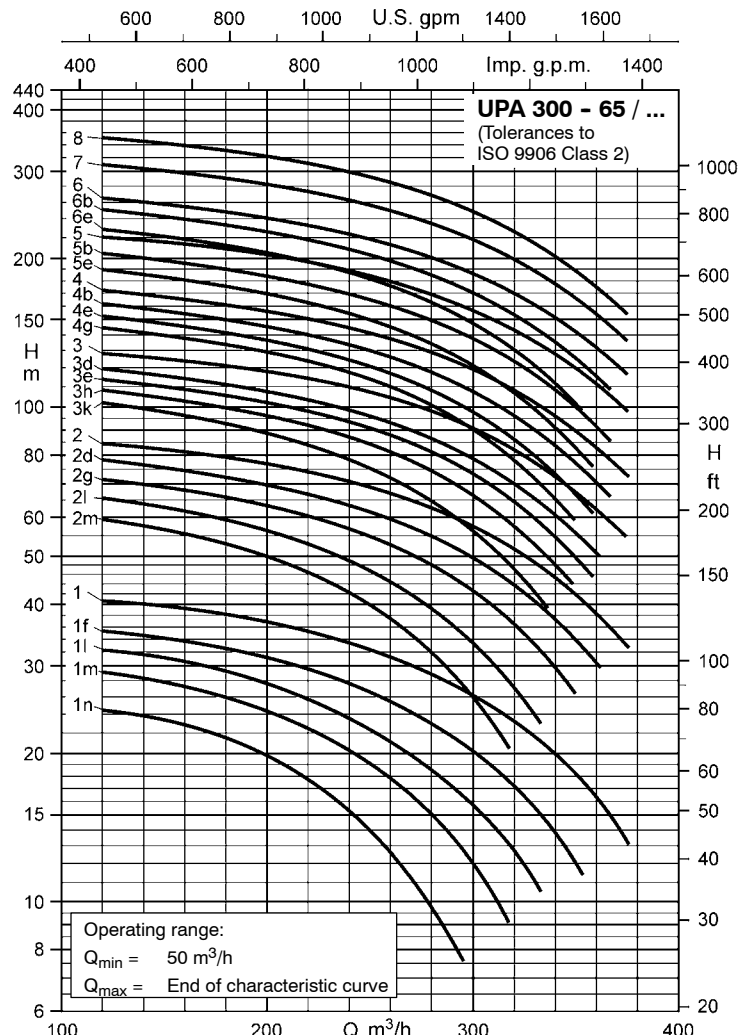
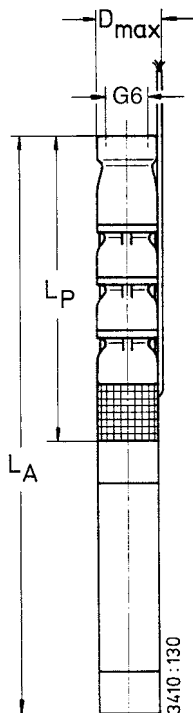

UPA 300 - 94 for Well Diameters of 300 mm (12 inches) and above

Pumps with submersible motors for **three-phase current (3 ~) / 400 V and d.o.l. (D) or star-delta (Y-Δ) starting**

Pump + motor	Pump		Motor				Motor lead ²⁾ , flat	
	Discharge head Q = 0 m³/h	Rated power	Max. temperature of the fluid pumped v ≥ 0.2 m/s (= 0 m/s)	Rated current	Efficiency	Power factor	Number x cross-section of conductors (use under water, 400 V and ≤ +30 °C)	
UPA 300 - 94/ ... + ...	H _o m	P _N kW	t _{max} ¹⁾ °C	I _N A	η _M %	cos φ --	D.o.l. mm²	Y-Δ mm²
1n + UMA 200D 37/21	34	29.0	37 (32)	62	85.6	0.80	3/4 x 6.0 ³⁾	3/4 x 6.0
1m + UMA 200D 37/21	38	32.0	34 (29)	67	85.5	0.82	3/4 x 6.0 ³⁾	3/4 x 6.0
1k + UMA 200D 37/21	43	36.0	30 (25)	73	85.3	0.84	3/4 x 6.0 ³⁾	3/4 x 6.0
1g + UMA 200D 45/21	47	42.0	31 (25)	85	86.1	0.83	3/4 x 6.0 ³⁾	3/4 x 6.0
1d + UMA 200D 45/21	51	45.0	27 (20)	90	86.0	0.84	3/4 x 6.0 ³⁾	3/4 x 6.0
1 + UMA 200D 55/21	54	54.0	29 (23)	108	87.0	0.84	3/4 x 6.0 ³⁾	3/4 x 6.0
2m + UMA 200D 65/21	78	62.0	29 (23)	123	87.7	0.83	3/4 x 10.0 ³⁾	3/4 x 10.0
2k + UMA 200D 75/21	90	74.0	25 (18)	149	87.3	0.83	3/4 x 10.0 ³⁾	3/4 x 10.0
2h + UMA 200D 90/21	96	82.0	28 (22)	167	88.2	0.81	3/4 x 16.0 ³⁾	3/4 x 16.0
2d + UMA 250D 110/21	105	95.0	26 (19)	191	88.7	0.81	3/4 x 25.0 ³⁾	3/4 x 25.0
2 + UMA 250D 110/21	112	110.0	20 (10)	215	88.5	0.84	3/4 x 25.0 ³⁾	3/4 x 25.0
3k + UMA 250D 110/21	138	110.0	20 (10)	215	88.5	0.84	3/4 x 25.0 ³⁾	3/4 x 25.0
3h + UMA 250D 132/21	146	125.0	24 (15)	237	89.1	0.86	3/4 x 25.0 ³⁾	3/4 x 25.0
3e + UMA 250D 132/21	155	130.0	20 (11)	245	89.1	0.86	3/4 x 25.0 ³⁾	3/4 x 25.0
3c + UMA 250D 160/21	162	145.0	20 (11)	276	89.4	0.85	3/4 x 25.0 ⁴⁾	3/4 x 35 ⁵⁾
3 + UMA 250D 190/21	172	165.0	22 (14)	325	90.0	0.82	3/4 x 35 ⁴⁾ 5)	3/4 x 50 ⁵⁾
4f + UMA 250D 190/21	204	175.0	19 (10)	341	89.9	0.83	3/4 x 35 ⁴⁾ 5)	3/4 x 50 ⁵⁾
4c + UMA 300D 250/22	222	205.0	57 (52)	382	90.6	0.86	2x3x70 + 1x35 ⁴⁾ 6)	2x3x70 + 1x35 ⁶⁾
4 + UMA 300D 250/22	232	225.0	55 (49)	414	90.7	0.87	2x3x70 + 1x35 ⁴⁾ 6)	2x3x70 + 1x35 ⁶⁾
5 + UMA 300D 300/22	290	280.0	54 (48)	516	91.2	0.86	6x1x95 + 1x95 ⁴⁾ 7)	6x1x95 + 1x95 ⁷⁾
6 + UMA 300D 400/22	348	335.0	52 (45)	619	91.4	0.86	6x1x95 + 1x95 ⁴⁾ 7)	6x1x95 + 1x95 ⁷⁾
7e + UMA 300D 400/22	371	315.0	54 (47)	586	91.4	0.85	6x1x95 + 1x95 ⁴⁾ 7)	6x1x95 + 1x95 ⁷⁾

1) also see pages 3 and 79.

2) 3/4 = 1 x 3-core and 1 x 4-core, 90° spacing.

3) Δ wiring in the cable connector or control cabinet.

4) Parallel cable

5) 1 x 3-core, flat and 1 x 4-core, round.

6) 2 x 3-core, flat and 1 x 1-core, round

7) 7 x 1-core, round

Dimensions / Weights / Horizontal Installation ¹⁾

UPA 300 - 94/ ..	L _p ≈ mm	L _A ≈ mm	D _{max} ≈ mm		m _A ≈ kg		Installation ²⁾	A ≈ mm
			D.o.l.	Y-Δ	G (Standard)	B (Special)		
1n	775	1915	286	286	227	245	v + h	960
1m	775	1915	286	286	227	245	v + h	960
1k	775	1915	286	286	227	245	v + h	960
1g	775	2005	286	286	253	271	v + h	1005
1d	775	2005	286	286	253	271	v + h	1005
1	775	2115	286	286	273	291	v + h	1060
2m	950	2420	285	285	329	352	v + h	1300
2k	950	2510	285	285	345	368	v + h	1345
2h	950	2690	288	288	377	400	v ³⁾	-
2d	980	2510	299	299	450	473	v + h	1360
2	980	2510	299	299	450	473	v + h	1360
3k	1155	2685	299	299	483	511	v + h	1535
3h	1155	2815	299	299	527	555	v + h	1600
3e	1155	2815	299	299	527	555	v + h	1600
3c	1155	2925	299	308	564	592	v + h	1655
3	1155	3075	308	321	615	643	v ³⁾ 4)	-
4f	1330	3250	308	321	648	681	v ³⁾ 4)	-
4c	1330	3405	331	331	797	831	v ⁴⁾	-
4	1330	3405	331	331	797	831	v ⁴⁾	-
5	1505	3760	311	311	908	947	v ⁴⁾	-
6	1680	4055	311	311	993	1037	v ³⁾ 4)	-
7e	1855	4230	311	311	1026	1075	v ³⁾ 4)	-

Including check valve with threaded end and standard motor leads.
v = vertical / h = horizontal.

3) Horizontal installation on request.

4) Horizontal installation only with bearing pedestals of special design.

UPA 300 - 94 / ..

The characteristic curves shown are for preliminary selection only. Exact selection data will be provided in our quotation.

Selection

The pressure losses H_v in the check valve are not considered in the pump characteristic curves. For more details and a selection example refer to page 8.

Legend ...

H_v : Head losses in the check valve

η_p : Pump efficiency (not considering check valve)

NPSH: Net positive suction head required by the pump

Pump End G 8" / DN 200

The information is based on the model "with check valve and threaded end".

The changes in the main dimensions of the "flanged end" model or the model "with connection branch" are specified in the table below.

a) Check valve with:

Threaded end G 8"		Flanged end DN 200	
Length mm	Length mm	Outside dia. mm	
290	240 (PN 10)	340	
	240 (PN 16)	340	
	244 (PN 25)	360	

b) Connection branch with:

Threaded end G 8"		Flanged end DN 200	
Length mm	Length mm	Outside dia. mm	
200	134 (PN 10)	340	
	134 (PN 16)	340	
	138 (PN 25)	360	

Threaded end to DIN ISO 228, Part 1.

Flange mating dimensions to DIN 2501, Part 1

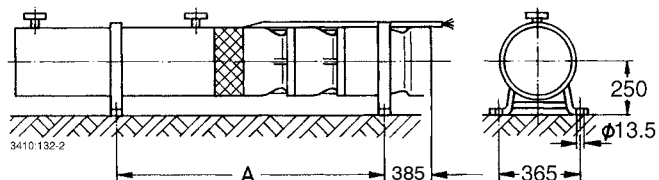
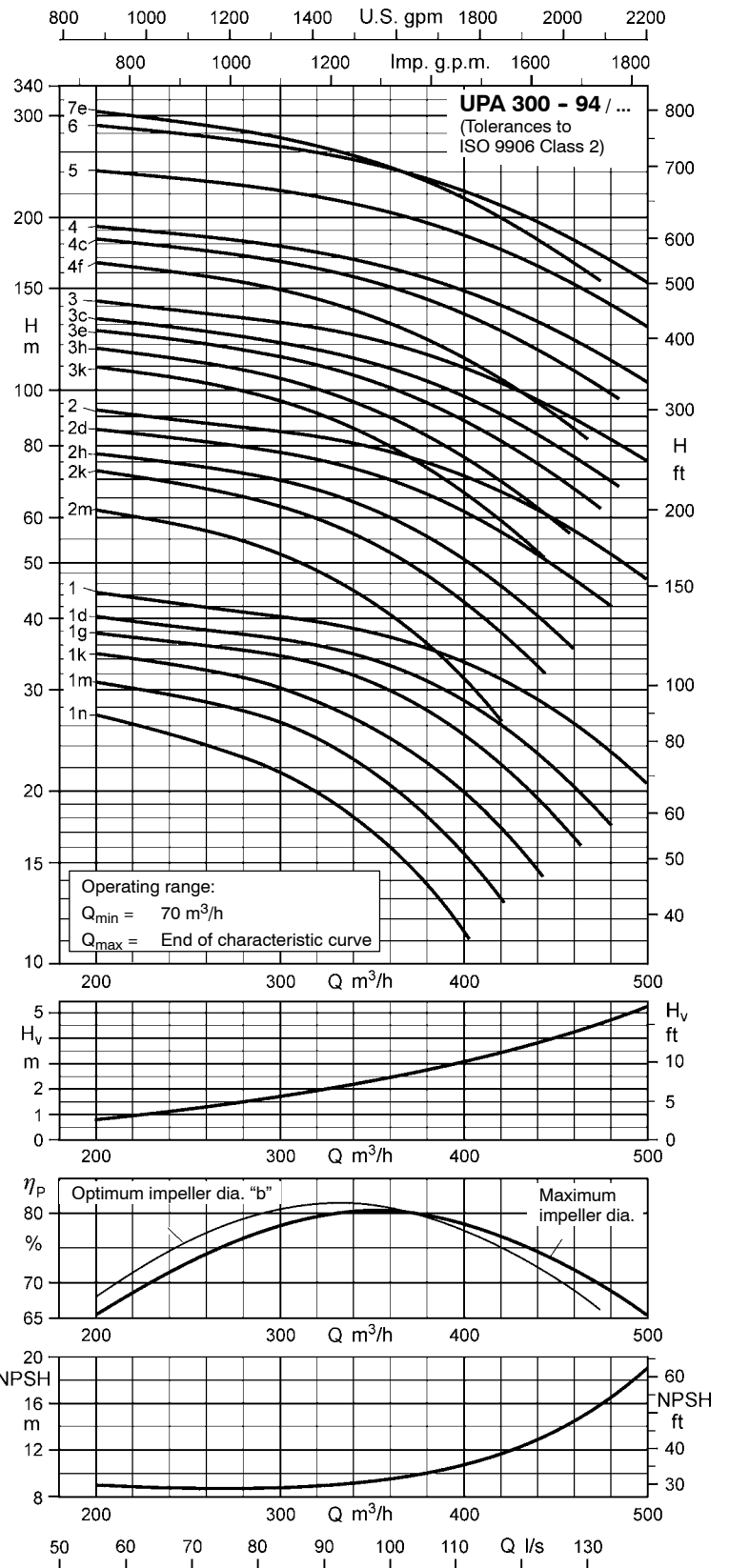
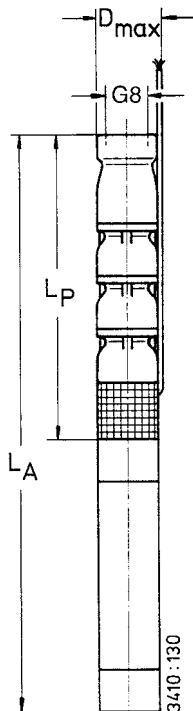

UPA 350 - 128 for Well Diameters of 350 mm (14 inches) and above

 Pumps with submersible motors for **three-phase current (3~) / 400 V** and **d.o.l. (D)** or **star-delta (Y-Δ)** starting

Pump + motor	Pump	Motor					Motor lead ²⁾ , flat	
	Discharge head Q = 0 m ³ /h	Rated power	Max. temperature of the fluid pumped v ≥ 0.2 m/s (= 0 m/s)	Rated current	Efficiency	Power factor	Number x cross-section of conductors (use under water, 400 V and ≤ +30 °C)	
UPA 350 - 128/ ... + ...	H _o m	P _N kW	t _{max} ¹⁾ °C	I _N A	η _M %	cos φ --	D.o.l. mm ²	Y-Δ mm ²
1l + UMA 200D 37/21	40	35.0	31 (25)	72	85.3	0.83	3/4 x 6.0 ³⁾	3/4 x 6.0
1k + UMA 200D 45/21	45	44.0	28 (22)	89	86.0	0.84	3/4 x 6.0 ³⁾	3/4 x 6.0
1h + UMA 200D 55/21	52	55.0	27 (20)	109	86.9	0.84	3/4 x 6.0 ³⁾	3/4 x 6.0
1f + UMA 200D 65/21	57	64.0	28 (22)	127	87.7	0.84	3/4 x 10.0 ³⁾	3/4 x 10.0
1d + UMA 200D 75/21	63	75.0	23 (15)	151	87.3	0.83	3/4 x 10.0 ³⁾	3/4 x 10.0
1b + UMA 200D 90/21	69	88.0	25 (18)	177	88.1	0.82	3/4 x 16.0 ³⁾	3/4 x 16.0
1 + UMA 250D 110/21	75	105.0	22 (14)	208	88.6	0.83	3/4 x 25.0 ³⁾	3/4 x 25.0
2h + UMA 250D 110/21	104	110.0	19 (10)	215	88.5	0.84	3/4 x 25.0 ³⁾	3/4 x 25.0
2g + UMA 250D 132/21	109	120.0	24 (16)	229	89.2	0.85	3/4 x 25.0 ³⁾	3/4 x 25.0
2e + UMA 250D 132/21	117	132.0	18 (9)	249	89.0	0.86	3/4 x 25.0 ³⁾	3/4 x 25.0
2d + UMA 250D 160/21	126	150.0	18 (9)	284	89.3	0.86	3/4 x 25.0 ⁴⁾	3/4 x 35 ⁵⁾
2b + UMA 250D 190/21	138	175.0	19 (10)	341	89.9	0.83	3/4 x 35 ⁴⁾ ⁵⁾	3/4 x 50 ⁵⁾
2 + UMA 300D 250/22	153	210.0	57 (51)	389	90.7	0.86	2x3x70 + 1x35 ⁴⁾ ⁶⁾	2x3x70 + 1x35 ⁶⁾
3c + UMA 300D 250/22	196	240.0	54 (47)	439	90.7	0.87	2x3x70 + 1x35 ⁴⁾ ⁶⁾	2x3x70 + 1x35 ⁶⁾
3 + UMA 300D 300/22	228	300.0	52 (45)	546	91.2	0.87	6x1x95 + 1x95 ⁴⁾ ⁷⁾	6x1x95 + 1x95 ⁷⁾
4b + UMA 300D 400/22	280	355.0	50 (42)	652	91.4	0.86	6x1x95 + 1x95 ⁴⁾ ⁷⁾	6x1x95 + 1x95 ⁷⁾
4 + UMA 300D 400/22	302	400.0	45 (35)	728	91.2	0.87	6x1x95 + 1x95 ⁴⁾ ⁷⁾	6x1x95 + 1x95 ⁷⁾

1) also see pages 3 and 79.

2) 3/4 = 1 x 3-core and 1 x 4-core, 90° spacing.

3) Δ wiring in the cable connector or control cabinet.

4) Parallel cable

5) 1 x 3-core, flat and 1 x 4-core, round.

6) 2 x 3-core, flat and 1 x 1-core, round

7) 7 x 1-core, round

Dimensions / Weights / Horizontal Installation ¹⁾

UPA 350 - 128/ ..	L _p ≈ mm	L _A ≈ mm	D _{max} ≈ mm		m _A ≈ kg		Installation ²⁾	A ≈ mm
			D.o.l	Y-Δ	G (Standard)	B (Special)		
1l	898	2040	322	322	243	265	v + h	1020
1k	898	2130	322	322	269	291	v + h	1065
1h	898	2240	322	322	289	311	v + h	1120
1f	898	2370	320	320	312	334	v + h	1185
1d	898	2460	320	320	328	350	v + h	1230
1b	898	2640	324	324	360	382	v ³⁾	-
1	898	2425	334	334	432	454	v + h	1215
2h	1098	2625	334	334	474	502	v + h	1415
2g	1098	2755	334	334	518	546	v + h	1480
2e	1098	2755	334	334	518	546	v + h	1480
2d	1098	2865	334	343	555	583	v + h	1535
2b	1098	3015	343	357	606	634	v ³⁾ ⁴⁾	-
2	1108	3180	360	360	764	793	v ⁴⁾	-
3c	1308	3380	360	360	806	840	v ⁴⁾	-
3	1308	3560	341	341	884	918	v ⁴⁾	-
4b	1508	3880	341	341	978	1018	v ³⁾ ⁴⁾	-
4	1508	3880	341	341	978	1018	v ³⁾ ⁴⁾	-

1) Including check valve with threaded end and standard motor leads.

2) v = vertical / h = horizontal.

3) Horizontal installation on request.

4) Horizontal installation only with bearing pedestals of special design.

UPA 350 - 128 / ..

The characteristic curves shown are for preliminary selection only. Exact selection data will be provided in our quotation.

Selection

The pressure losses H_v in the check valve are not considered in the pump characteristic curves. For more details and a selection example refer to page 8.

Legend ...

- H_v : Head losses in the check valve
- η_p : Pump efficiency (not considering check valve)
- NPSH: Net positive suction head required by the pump

Pump End G 8" / DN 200 1)

The information is based on the model "with check valve and threaded end". The changes in the main dimensions of the "flanged end" model or the model "with connection branch" are specified in the table below.

a) Check valve with:

Threaded end G 8"		Flanged end DN 200	
Length mm	Length mm	Outside dia. mm	
328	278 (PN 10) 278 (PN 16)	340	

b) Connection branch with:

Threaded end G 8"		Flanged end DN 200	
Length mm	Length mm	Outside dia. mm	
169	123 (PN 10) 123 (PN 16)	340	

Threaded end to DIN ISO 228, Part 1

Flange mating dimensions to DIN 2501, Part 1

1) DN 250 check valve (with flanged end only) on request. For relevant head losses see H_v curve plotted over Q.

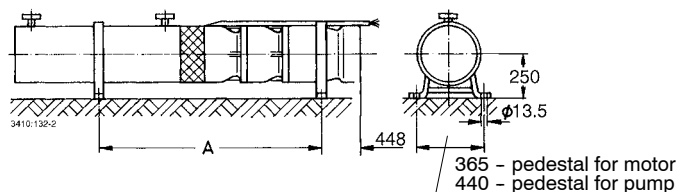
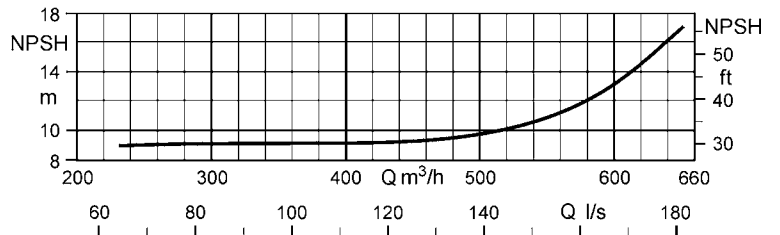
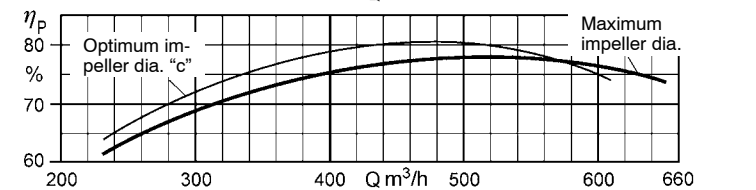
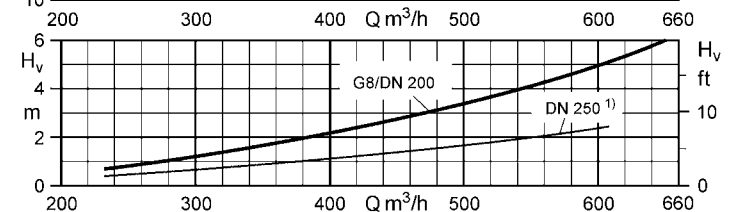
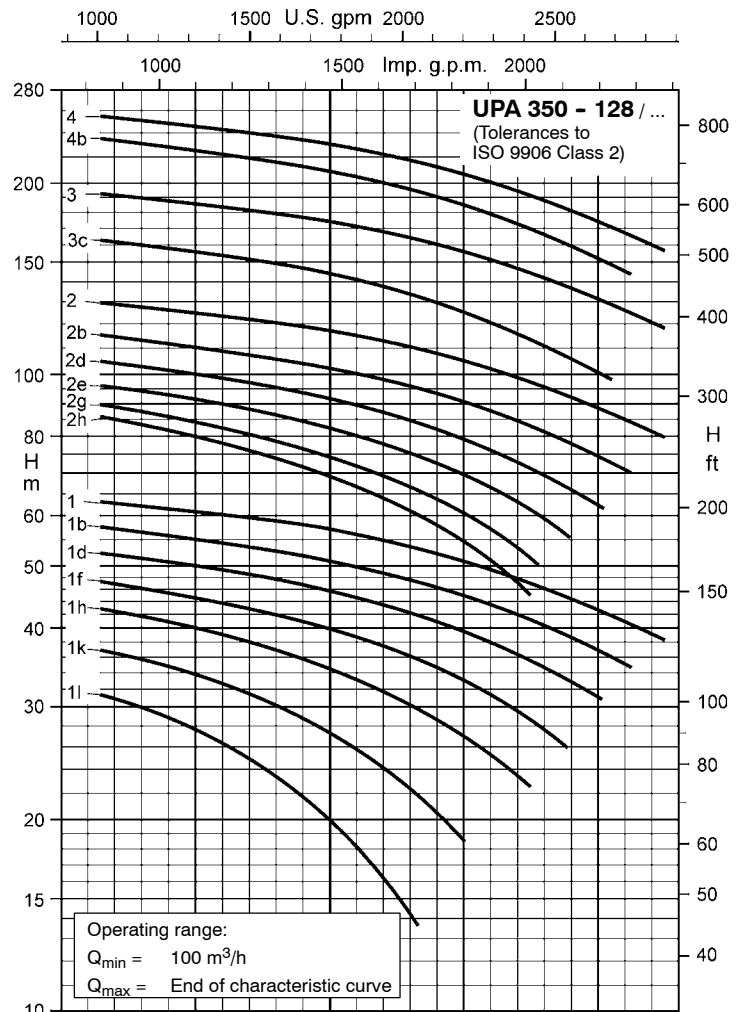
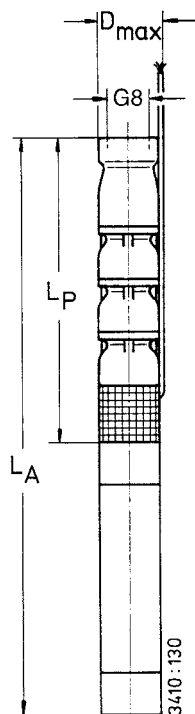

UPA 350 - 180 for Well Diameters of 350 mm (14 inches) and above

 Pumps with submersible motors for **three-phase current (3~) / 400 V** and **d.o.l. (D)** or **star-delta (Y-Δ)** starting

Pump + motor	Pump	Motor					Motor lead ²⁾ , flat	
	Discharge head Q = 0 m ³ /h	Rated power	Max. temperature of the fluid pumped v ≥ 0.2 m/s (= 0 m/s)	Rated current	Efficiency	Power factor	Number x cross-section of conductors (use under water, 400 V and ≤ +30°C)	
UPA 350 - 180/ ... + ...	H ₀ m	P _N kW	t _{max} ¹⁾ °C	I _N A	η _M %	cos φ --	D.o.l. mm ²	Y-Δ mm ²
1m + UMA 200D 55/21	41	54.0	29 (23)	108	87.0	0.84	3/4 x 6.0 ³⁾	3/4 x 6.0
1l + UMA 200D 65/21	45	62.0	30 (24)	123	87.7	0.83	3/4 x 10.0 ³⁾	3/4 x 10.0
1h + UMA 200D 65/21	49	65.0	28 (21)	129	87.7	0.84	3/4 x 10.0 ³⁾	3/4 x 10.0
1e + UMA 200D 75/21	55	75.0	24 (16)	151	87.3	0.83	3/4 x 10.0 ³⁾	3/4 x 10.0
1c + UMA 200D 90/21	62	86.0	27 (20)	173	88.1	0.82	3/4 x 16.0 ³⁾	3/4 x 16.0
1 + UMA 250D 110/21	66	100.0	25 (17)	199	88.6	0.82	3/4 x 25.0 ³⁾	3/4 x 25.0
2k + UMA 250D 132/21	95	130.0	22 (13)	245	89.1	0.86	3/4 x 25.0 ³⁾	3/4 x 25.0
2g + UMA 250D 132/21	100	132.0	18 (9)	249	89.0	0.86	3/4 x 25.0 ³⁾	3/4 x 25.0
2f + UMA 250D 160/21	111	150.0	20 (11)	284	89.3	0.86	3/4 x 25.0 ⁴⁾	3/4 x 35 ⁵⁾
2d + UMA 250D 190/21	121	165.0	22 (14)	325	90.0	0.82	3/4 x 35 ⁴⁾ ⁵⁾	3/4 x 50 ⁵⁾
2b + UMA 250D 190/21	128	180.0	18 (9)	349	89.8	0.83	3/4 x 35 ⁴⁾ ⁵⁾	3/4 x 50 ⁵⁾
2 + UMA 300D 250/22	137	210.0	57 (51)	389	90.7	0.86	2x3x70 + 1x35 ⁴⁾ ⁶⁾	2x3x70 + 1x35 ⁶⁾
3e + UMA 300D 250/22	173	240.0	53 (47)	439	90.7	0.87	2x3x70 + 1x35 ⁴⁾ ⁶⁾	2x3x70 + 1x35 ⁶⁾
3 + UMA 300D 400/22	205	320.0	54 (47)	595	91.4	0.85	6x1x95 + 1x95 ⁴⁾ ⁷⁾	6x1x95 + 1x95 ⁷⁾
4f + UMA 300D 400/22	226	310.0	54 (47)	580	91.4	0.85	6x1x95 + 1x95 ⁴⁾ ⁷⁾	6x1x95 + 1x95 ⁷⁾
4d + UMA 300D 400/22	245	345.0	51 (44)	634	91.4	0.86	6x1x95 + 1x95 ⁴⁾ ⁷⁾	6x1x95 + 1x95 ⁷⁾

¹⁾ also see pages 3 and 79.

²⁾ 3/4 = 1 x 3-core and 1 x 4-core, 90° spacing

³⁾ Δ-wiring in the cable connector or control cabinet.

⁴⁾ Parallel

⁵⁾ 1 x 3-core, flat and 1 x 4-core, round.

⁶⁾ 2 x 3-core, flat and 1 x 1-core, round

⁷⁾ 7 x 1-core, round

Dimensions / Weights / Horizontal Installation ¹⁾

UPA 350 - 180/ ..	L _p ≈ mm	L _A ≈ mm	D _{max} ≈ mm		m _A = kg		Installation ²⁾	A ≈ mm
			D.o.l	Y-Δ	G (Standard)	B (Special)		
1m	898	2240	322	322	289	311	v + h	1120
1l	898	2370	320	320	312	334	v + h	1185
1h	898	2370	320	320	312	334	v + h	1185
1e	898	2460	320	320	328	350	v + h	1230
1c	898	2640	324	324	360	382	v ³⁾	-
1	898	2425	334	334	432	454	v + h	1215
2k	1098	2755	334	334	518	546	v + h	1480
2g	1098	2755	334	334	518	546	v + h	1480
2f	1098	2865	334	343	555	583	v + h	1535
2d	1098	3015	343	357	606	634	v ³⁾ ⁴⁾	-
2b	1098	3015	343	357	606	634	v ³⁾ ⁴⁾	-
2	1108	3180	360	360	764	793	v ⁴⁾	-
3e	1308	3380	360	360	806	840	v ⁴⁾	-
3	1308	3680	341	341	936	970	v ³⁾ ⁴⁾	-
4f	1508	3880	341	341	978	1018	v ³⁾ ⁴⁾	-
4d	1508	3880	341	341	978	1018	v ³⁾ ⁴⁾	-

¹⁾ Including check valve with threaded end and standard motor leads.

²⁾ v = vertical / h = horizontal.

³⁾ Horizontal installation on request.

⁴⁾ Horizontal installation only with bearing pedestals of special design.

UPA 350 - 180 /..

The characteristic curves shown are for preliminary selection only. Exact selection data will be provided in our quotation.

Larger discharge heads (units with UMA 300D motors) on request.

Selection

The pressure losses H_v in the check valve are not considered in the pump characteristic curves. For more details and a selection example refer to page 8.

Legend ...

H_v : Head losses in the check valve

η_p : Pump efficiency (not considering check valve)

NPSH: Net positive suction head required by the pump

Pump End G 8" / DN 200 1)

The information is based on the model "with check valve and threaded end".

The changes in the main dimensions of the "flanged end" model or the model "with connection branch" are specified in the table below.

a) Check valve with:

Threaded end G 8"		Flanged end DN 200	
Length mm	Length mm	Outside dia. mm	
328	278 (PN 10) 278 (PN 16)	340	

b) Connection branch with:

Threaded end G 8"		Flanged end DN 200	
Length mm	Length mm	Outside dia. mm	
169	123 (PN 10) 123 (PN 16)	340	

Threaded end to DIN ISO 228, Part 1.

Flange mating dimensions to DIN 2501, Part 1

1) DN 250 check valve (with flanged end only) on request. For relevant head losses see H_v curve plotted over Q.

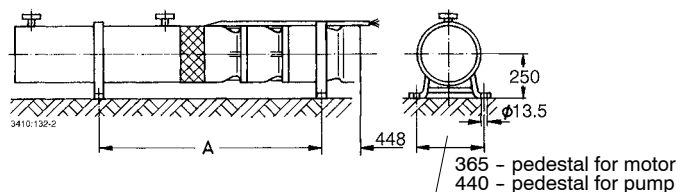
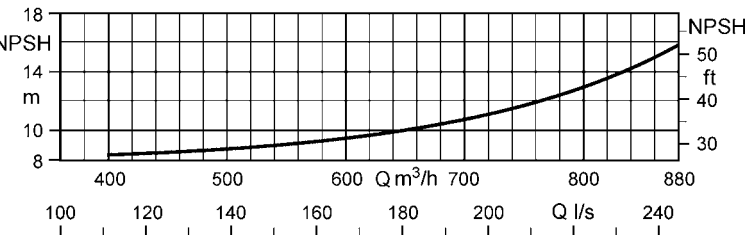
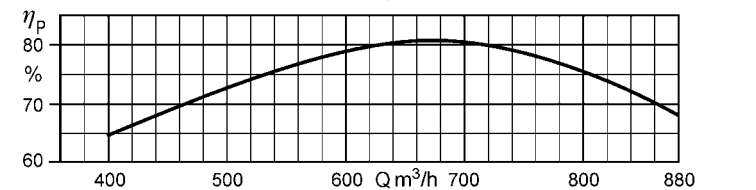
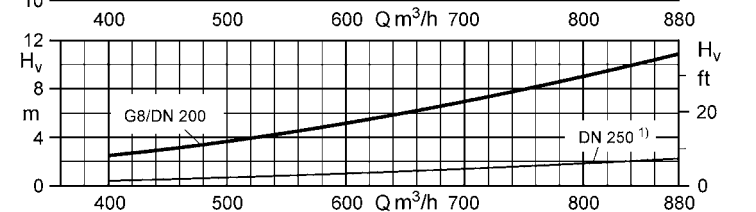
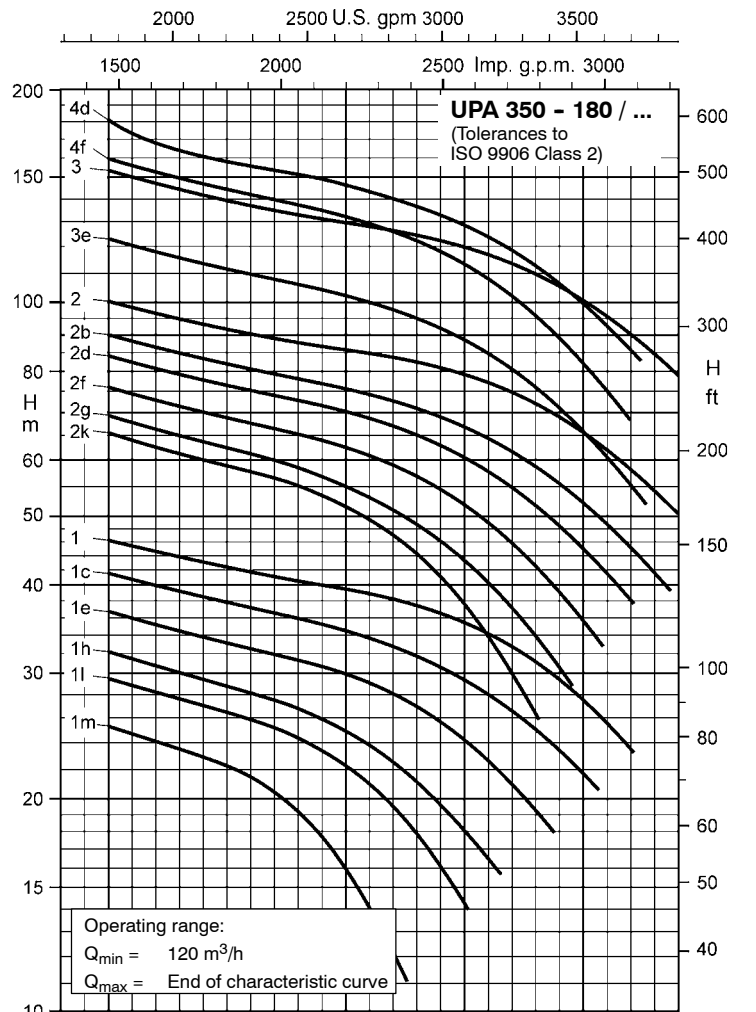
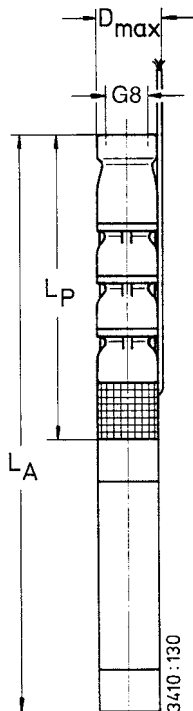

Applications

Handling clean and raw water in applications such as:

- general water extraction / supply,
- irrigation and spray irrigation,
- lowering and maintaining ground water levels in open-cast mines,
- dewatering and gallery drainage in underground mines.

Use in pressure-boosting as well as for offshore and cavern applications, etc.

Permissible sand content in the fluid handled: 50 g/m³.

Operating Data

Capacity	Q up to 2200 m ³ /h (610 l/s)
Head	H up to 240 m
Temperature of fluid handled	t up to + 50 °C
Speed	n ≈ 1450 rpm

Design

Single- or multi-stage, single-entry centrifugal pumps in ring-section design. For vertical and horizontal installation. Mixed flow hydraulic systems, also available with reduced impeller diameters. Stage casings connected by means of studs.

Suction casing between pump and motor equipped with strainer to protect the pump from coarse particles in the fluid.

Pumps with check valve or connection branch on option. Both models with flanged end.

Particularly suitable for installation in narrow deep wells.

Designation (Example)

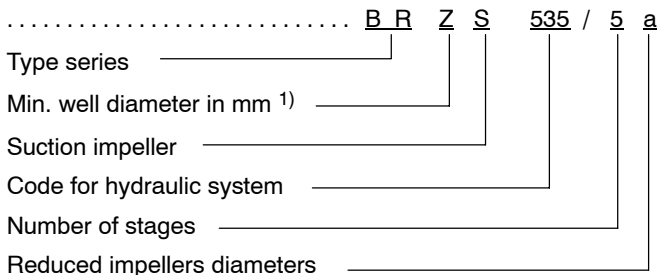

¹⁾ X = 400 mm (16 inches), Y = 450 mm (18 inches),
 Z = 500 mm (20 inches), E = 600 mm (24 inches),
 F = 650 mm (26 inches)

Certification

Quality management certified to ISO 9001

Submersible Borehole Pumps for Well Diameters of 400 mm (16 inches) and above



Product Features

- Very sturdy design
- Suitable for installation in narrow deep wells
- High efficiency
- Motor designed for maximum pump output
- Low noise level
- For vertical or horizontal installation
- Check valve protected against blocking
- Pre-filled motor; no risk of contamination of the handled water

Selection Chart (Ranges on Offer)

$n \approx 1450$ rpm

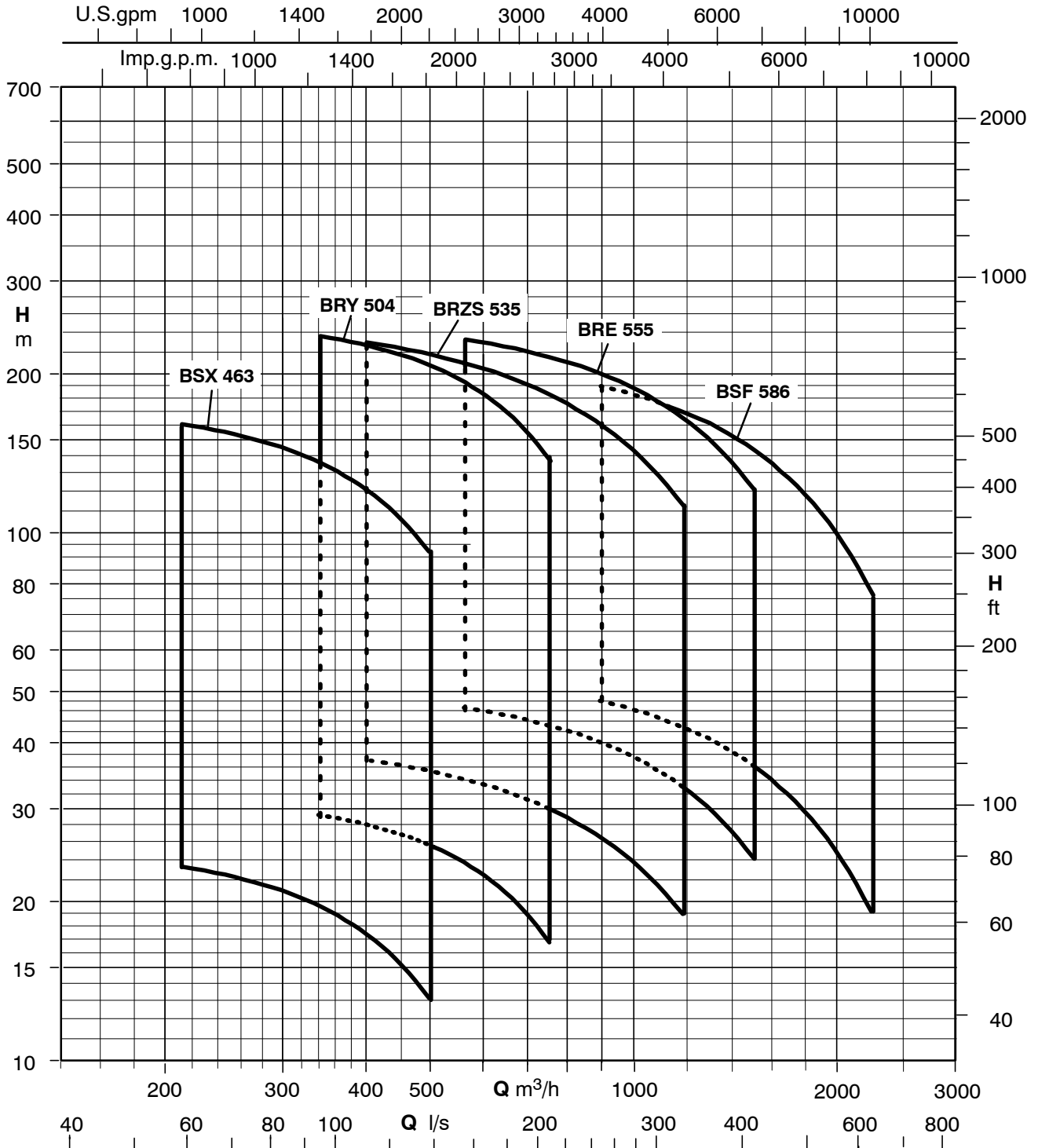

3430:80

Note: The diagram shows the ΔQA range on offer. The pumps can be offered for any duty point within this flow range.

Applications

Handling clean and raw water in applications such as:

- general water extraction / supply,
- irrigation and spray irrigation,
- lowering and maintaining ground water levels in open-cast mines,
- dewatering and gallery drainage in underground mines.

Use in pressure-boosting as well as for offshore and cavern applications, etc.

Permissible sand content in the fluid handled: 50 g/m³.

Operating Data

Capacity	Q	up to 2,200 m ³ /h (612 l/s)
Head	H	up to 1,500 m
Supply voltage	U	up to 6,600 V
Temperature of fluid handled	t	up to +40 °C
Speed	n	2900 rpm and 1450 rpm

Design

Multistage, double-entry ring-section pump with back-to-back impeller arrangement. For vertical installation. Radial and mixed-flow hydraulic systems with impellers that can be turned down.

Half the flow enters the pump through the lower suction casing, the other half through the upper suction casing. The upper half of the pump unit is surrounded by a pressure shroud (outer shell). The two flows are collected by the channel created by the shroud and carried into the upper suction casing, which is equipped with two discharge branches. This configuration is designed to ensure full axial thrust balancing. The casing components (stage casings) are connected by means of round tie bolts. The two suction casings are equipped with strainers to protect the pump from coarse particles in the fluid. Flanged pump end. Check valve with flanged end available on request.

Particularly suitable for installation in narrow deep wells.

Pump Designation (Example)

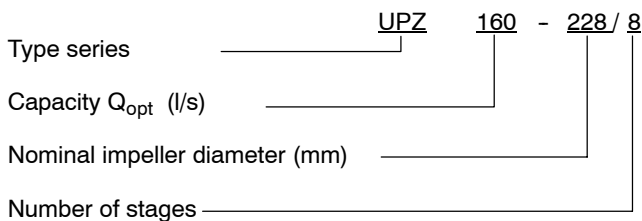

Certification

Quality management certified to ISO 9001

Submersible Borehole Pumps for Well Diameters of 500 mm (20 inches) and above



Selection Chart (Ranges on Offer)

$n \approx 2900$ rpm and $n \approx 1450$ rpm

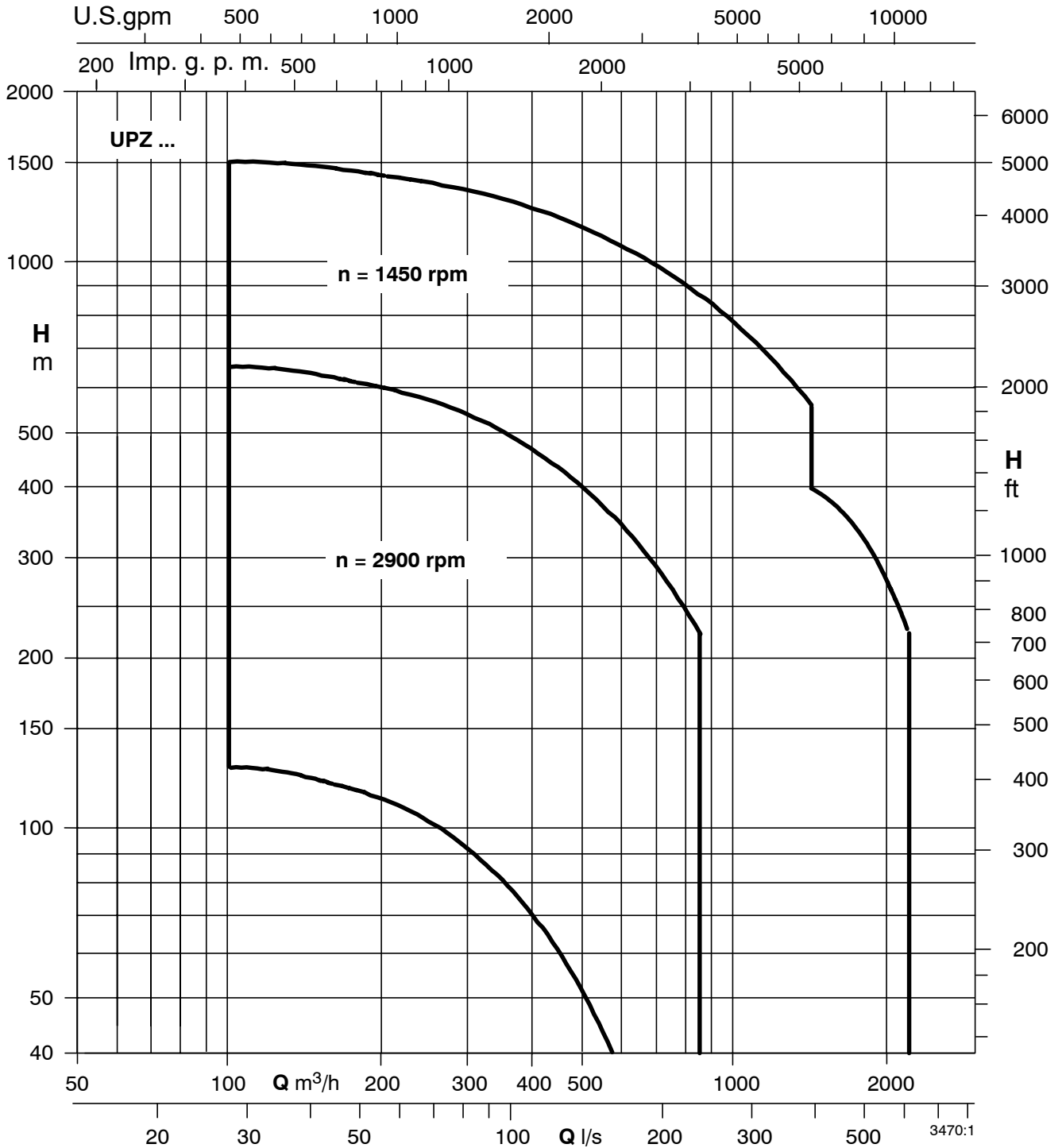

Note: The diagram shows the ΔQ_A range on offer. The pumps can be offered for any duty point within this flow range.