

Water treatment and water disinfection

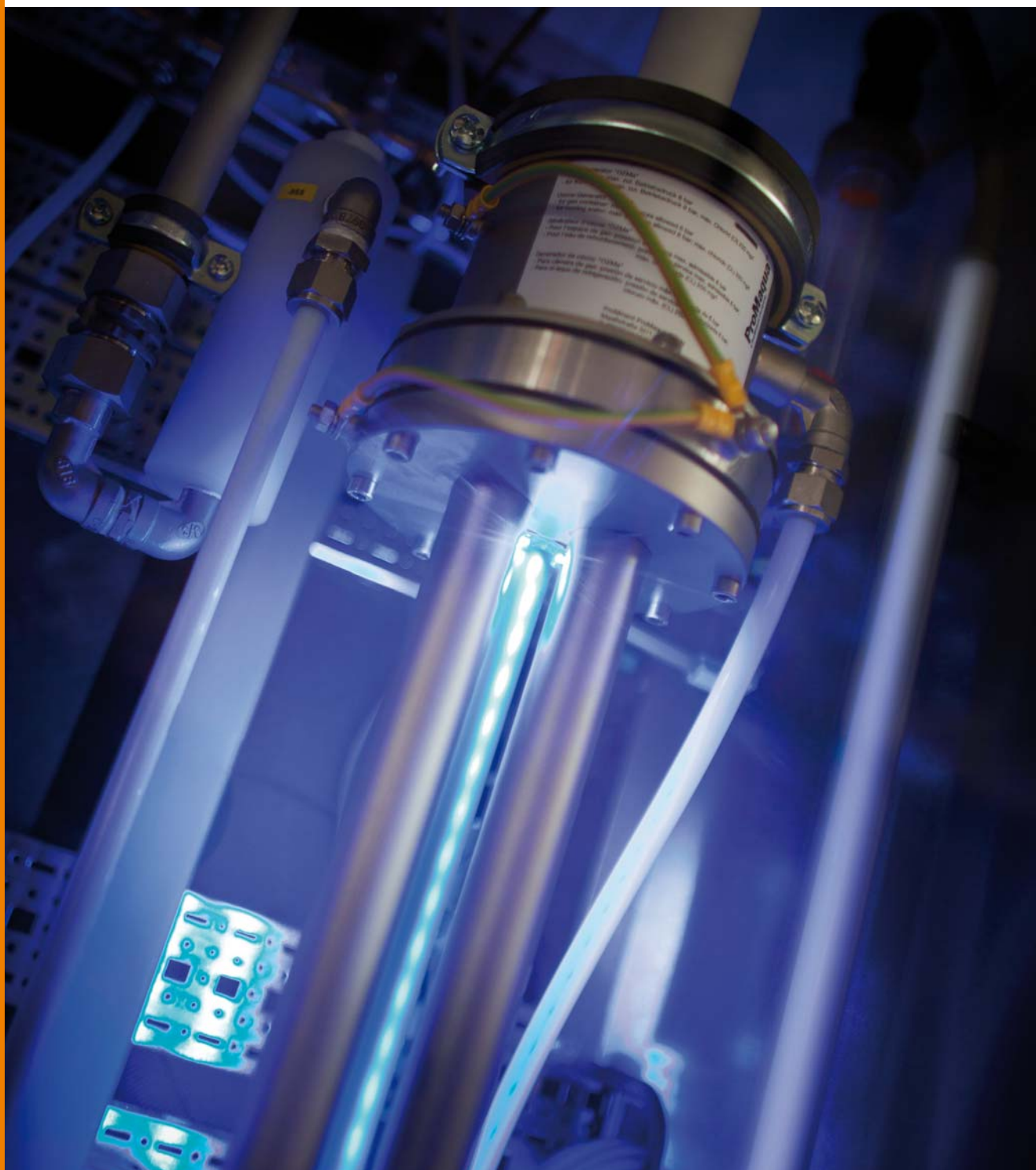

2 OZONFILT® and Bono Zon® Ozone Plants

2.1 Ozone in Water Treatment

As the most powerful oxidant that can be used in water treatment, ozone permits a broad spectrum of possible applications:

Outstanding disinfection efficiency against

- Bacteria and viruses
- Fungi and parasites

Oxidation of undesirable inorganic substances in the water

- Iron and manganese
- Arsenic
- Nitrite and sulfide

Oxidation of undesirable organic substances in the water

- Strong-smelling and strong-tasting compounds
- Humic substances and other compounds which affect the colour of the water
- Cyclic hydrocarbons
- Trihalomethanes, chloramines and other chlorine compounds

Microflocculating action

- After oxidation with ozone, substances and colloids dissolved in the water become insoluble and can be filtered

Significantly less environmentally-harmful by-products occur in the production and use of ozone, than with other comparable oxidants and disinfectants. As a highly reactive gas, ozone is produced on site, and introduced to the water directly, without interim storage. Because of its high reactivity, ozone decomposes into oxygen again in the water, with a half-life of several minutes. All components of an ozone handling system should be perfectly coordinated to each other and the planned application, to achieve an optimum relationship between ozone production and its effect.

With every new project, our engineers can draw on experience that we have accumulated since 1971, in the following applications:

Potable water supply

- Oxidation of iron, manganese or arsenic
- Improvement in appearance and taste
- Disinfection

Food and beverage industry

- Disinfection of mineral water
- Disinfection of rinsers in the beverage industry
- Disinfection of production water

Swimming pools

- Reduction of chloramines and trihalomethanes, avoiding typical swimming pool odours
- Crystal-clear water thanks to micro-flocculating action
- Reliable microbiological barriers in therapy pools
- Reduction of investment and operating costs by the possibility of reducing the circulating power and throttling the fresh water inlet

Industry

- Cooling water treatment
- Combating legionella in cooling water circuits
- Disinfection of process water
- Removal of odorous substances in air scrubbers

2 OZONFILT® and Bono Zon® Ozone Plants

2.2 Performance Overview of Ozone Plants

ProMaqua® ozone plants function according to the proven principle of dielectric barrier discharge. By applying a high voltage of several thousands of Volts, ozone is produced from oxygen between two electrodes separated by an insulating dielectric. Depending on the plant type, either dried ambient air or concentrated oxygen is used as oxygen source. ProMaqua® ozone plants are optimised to ensure maximum profitability and operating safety. They meet the German standard for ozone generation plants DIN 19627 and are characterised by low energy and cooling water consumption.

Medium-frequency pressure systems

With the OZONFILT® OZVa and OZMa range, the operating gas air or oxygen is fed to the ozone generator under pressure. Ozone is generated using medium-frequency high voltage.

The use of an integrated variable pressure swing dryer and a dielectric with optimum thermal conductivity results in the extraordinarily compact design of the plant.

Thanks to operation under pressure, the ozone generated can be directly fed to water systems with a backpressure of up to 2 bar. Additional pressure-boosting pumps and injectors thus become superfluous in many applications.

Vacuum systems

With the Bono Zon® BONa range, the operating gas air is suctioned through the air dryer and the ozone generator with the help of a pressure-boosting pump and an injector system. The ozone itself is generated under mains frequency and is controlled by changing the high voltage. Operation in a vacuum ensures very safe operation.

ProMaqua® offers a number of ozone plants for diverse applications. The overview below shows the capacity ranges of our series types:

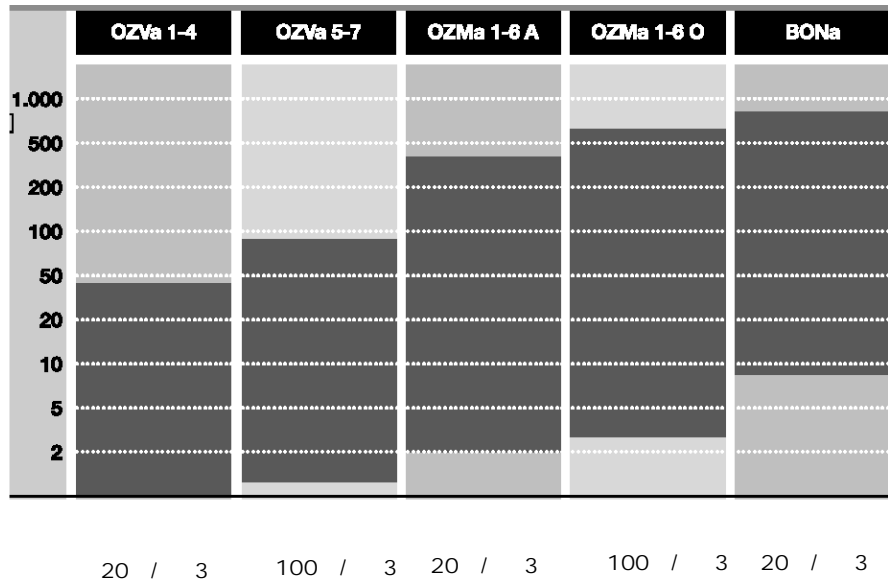

larger systems available on request

ProMaqua provides all the advice needed for the safe operation of an ozone plant:

- Evaluation of the situation on site by trained, expert field sales staff.
- In our water laboratory, we can measure all of the key water parameters required for an optimum plant design.
- Planning of the plant.
- Commissioning and plant service by our trained service technicians.

2 OZONFILT® and Bono Zon® Ozone Plants

2.3 Questionnaire on the Design of an Ozone Plant

Use of the ozone system:

- for treatment of
 - Drinking water
 - Product water in the food and beverages industry, cosmetics or pharmaceutical industry
 - Industrial water
 - Cooling water
 - Swimming pool water
 - Zoo
 - _____
- for oxidation of
 - Iron, manganese, nitrite, sulphide etc.
 - Organic matter
 - Discolouration
 - _____
- _____

Water values:

- | | | | |
|----------------------|-----------------------------------|---|--|
| Max. water flow rate | _____ m ³ /h | Maximum water pressure | _____ bar |
| Water flow rate | <input type="checkbox"/> constant | <input type="checkbox"/> fluctuating from | _____ m ³ /h to _____ m ³ /h |
| pH value | _____ | Iron (Fe ²⁺) | _____ mg/l |
| Temperature | _____ °C | Manganese (Mn ²⁺) | _____ mg/l |
| Solid fraction | _____ mg/l | Nitrite (NO ₂ ⁻) | _____ mg/l |
| | | Sulphide (S ²⁻) | _____ mg/l |
| | | TOC (total organic carbon) | _____ mg/l |

Response time to application:

_____ m³ volume reaction tank or _____ minutes residence time in entire system.

Type of metering:

- constant
- flow-proportional
- depending on measured value

Desired amount of metering: _____ mg/l

Other requirements:

2 OZONFILT® and Bono Zon® Ozone Plants

2.4 OZONFILT® OZVa

OZONFILT® OZVa ozone plants have been designed as pressurised plants, in which the operating gas – air or oxygen – is fed into the ozone generator under pressure. The ozone is generated using medium-frequency high voltage and is primary current controlled. The introduction of PCC (primary current controlled) technology, specially developed in-house by ProMaqua, provides complete protection for the electrical components (high-voltage transformer and power stage) and also permits the correct digital display of the ozone feed rate in “grams/hour”. As a result, any required ozone volume between 3 and 100 % of the nominal capacity can be set reproducibly, and largely independently of voltage and pressure fluctuations.

The use of an integrated pressure swing dryer and a dielectric with optimum thermal conductivity makes the plant extremely compact. The unique design of the generator ensures outstanding cooling performance with low cooling water consumption and removes the heat produced quickly before the ozone produced can decompose due to excessive heat.

Operation under pressure means that the ozone generated can be introduced directly into water systems with back pressures of up to 2 bar. Additional booster pumps and injectors can therefore be dispensed with in many applications.

Combined with DULCOMETER® measuring and control technology and DULCOTEST® OZE ozone sensors, these systems are especially suitable for use where the operation is dependent on, and is controlled, by the measured data.

Features

- Simple operation
- Fully equipped
- High efficiency
- Low consumption of energy and cooling water
- High ozone concentration thanks to operation with oxygen
- PCC technology ensures complete protection of electrical components
- Correct digital display of ozone output in g/h
- Reproducible setting of the desired ozone quantity between 3 and 100 % of nominal capacity

2 OZONFILT® and Bono Zon® Ozone Plants

2.4.1

OZONFILT® Ozone Production Plants OZVa 1-4 (Operating Gas - Air)

Under nominal conditions, the OZVa 1-4 range produces up to 40 g/h of ozone from oxygen in the surrounding air at a concentration of 20 g/Nm³. Using the designated mixing devices, ozone concentrations of between 3 and 12 ppm can be achieved in the water to be treated, depending on the temperature (theoretical value at 30 or 0 °C).

OZVa 1 and 2 are installed in a control cabinet for wall mounting; OZVa 3 and 4 are installed in a free-standing cabinet.

An adequate supply of compressed air and a mixing device designed for the operating conditions should be provided for operation of the ozone plant.

Compressed air requirements

- Oil- and dust-free, non-corrosive
- Constant upstream pressure of 6 - 10 bar
- Required air quantities:
 - OZVa 1: 6.2l/min
 - OZVa 2: 17 l/min
 - OZVa 3: 38 l/min
 - OZVa 4: 42 l/min

Mixing device

OZVa 1 can be ordered in the following versions:

- Transparent mixing system with flow monitor mounted at the side of the plant (see fig. pk_7_001_1_V2)
- Static helical mixer mounted directly below the plant, made of PVC, with 4 helical blades (pressure drop approx. 0.4 bar at maximum throughput) (see fig. pk_7_042_V2)
- Without mixing system for connection of 12/10 mm stainless steel pipes or 12/9 mm PTFE pipes

OZVa 2 can be ordered in the following versions:

- Static helical mixer mounted directly below the plant, made of PVC, with 4 helical blades (pressure drop approx. 0.4 bar at maximum throughput) (see fig. pk_7_042_V2)
- Without mixing system for connection of 12/10 mm stainless steel pipes or 12/9 mm PTFE pipes

OZVa 3 and 4 are in principle delivered without mixing system; a suitable mixing system should be ordered separately (see Fig. pk_07_043_V2).

Static Helical Mixer Made of PVC or Stainless Steel see p. → 2-26

Notes

- The length of ozone gas-transporting pipes and the number of joints should be kept to a minimum. All rooms with a removable joint are to be monitored with a gas detector according to applicable German accident prevention regulations. All OZONFILT® plants are equipped for fitting a gas detector, such as a GMA 36 Ozon (see Accessories).
- The ozone generator must be interlocked with the water flow into the metering on all installations.
- A non-return valve should be installed upstream of the OZVa.

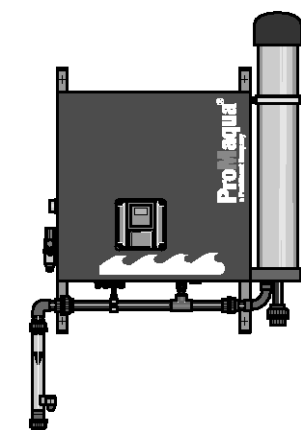

pk_7_001_1_V2

OZONFILT® OZVa 1; capacity: 5 g/h

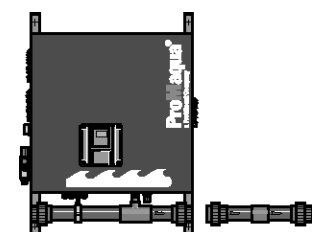

pk_7_042_V2

OZONFILT® OZVa 2; capacity: 15 g/h

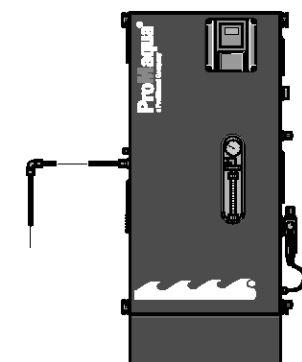

pk_7_043_V2

OZONFILT® OZVa 3; capacity: 35 g/h

2 OZONFILT® and Bono Zon® Ozone Plants

Technical Data

OZONFILT® OZVa 1-4 Ozone production plants (operating gas - air)

Environmental parameters

Max. humidity of the surrounding air 85 %, non-condensing, non-corrosive, dust-free,
 max. ambient temperature: 40 °C

| | | OZVa 1 | OZVa 2 | OZVa 3 | OZVa 4 |
|--|---------------------|--|--|-----------------|-----------------|
| Number of generator modules | | 1 | 1 | 2 | 2 |
| Ozone capacity, measured in accordance with DIN with air at 20 °C, cooling water at 15 °C | g/h | 5 | 15 | 35 | 40 |
| Air consumption (only ozone generation) | Nm ³ /h | 0.25 | 0.75 | 1.75 | 2.00 |
| Ozone concentration in the gas phase referenced to nominal conditions | g/Nm ³ * | 20 | 20 | 20 | 20 |
| Specific energy requirement at nominal capacity | Wh/g | 30 | 30 | 21 | 20 |
| Power factor at full capacity | cos φ | 0.70 | 0.98 | 0.98 | 0.98 |
| Ozone connection | | integrated in mixing device or G 1/4" internal | integrated in mixing device or G 1/4" internal | G 1/4" internal | G 1/4" internal |

* with air at 20 °C, cooling water at 15 °C

** Nm³ = m³ under standard conditions (p = 1.013x10⁵ Pa, T = 273 K)

Electrical connection

| | | OZVa 1 | OZVa 2 | OZVa 3 | OZVa 4 |
|-------------------------|--------|---------------|-------------|-------------|-------------|
| Connected load | V/Hz/A | 230/50;60/1,2 | 230/50;60/3 | 230/50;60/6 | 230/50;60/6 |
| Enclosure rating | | IP 43 | IP 43 | IP 43 | IP 43 |

Overall dimensions (without mixer)

| | | OZVa 1 | OZVa 2 | OZVa 3 | OZVa 4 |
|---------------|----|--------|--------|--------|--------|
| Width | mm | 840 | 840 | 710 | 710 |
| Height | mm | 840 | 805 | 1,400 | 1,400 |
| Depth | mm | 310 | 310 | 310 | 310 |

Weight

| | | OZVa 1 | OZVa 2 | OZVa 3 | OZVa 4 |
|---------------|----|--------|--------|--------|--------|
| Weight | kg | 70 | 75 | 121 | 121 |

Ozone mixing

| | | OZVa 1 | OZVa 2 | OZVa 3 | OZVa 4 |
|---|-----|---------|---------|---------|---------|
| Max. raw water temperature | °C | 35 | 35 | 35 | 35 |
| Permissible pressure at ozone outlet | bar | 0.8–2.0 | 0.8–2.0 | 0.8–2.0 | 0.8–1.5 |

Air supply

| | | OZVa 1 | OZVa 2 | OZVa 3 | OZVa 4 |
|----------------------------|--------|--------|--------|--------|--------|
| Required air volume | Nl/min | 6.2 | 17 | 38 | 42 |

Air quality oil and dust-free, non-corrosive, constant upstream pressure of 6-10 bar

Cooling water

| | | OZVa 1 | OZVa 2 | OZVa 3 | OZVa 4 |
|--|-----|--------|--------|--------|--------|
| Cooling water requirement | l/h | 10–60 | 20–60 | 50–100 | 70–100 |
| Cooling water inlet pressure | bar | 1–5 | 1–5 | 1–5 | 1–5 |
| Cooling water inlet, PE pressure hose | mm | 6 x 4 | 6 x 4 | 6 x 4 | 6 x 4 |
| Cooling water outlet, open discharge | mm | 6 x 4 | 6 x 4 | 6 x 4 | 6 x 4 |
| Cooling water temperature at ambient temp. max. 35 °C | °C | <30 | <30 | <30 | <30 |
| Cooling water temperature at ambient temp. 35–40 °C | °C | <25 | <25 | <25 | <25 |

Cooling water quality No tendency to form lime scale; Removable substances: < 0.1 ml/l ; Iron: < 0.2 mg/l; Manganese: < 0.05 mg/l; no corrosive components; Conductivity: > 100 µS/cm

2 OZONFILT® and Bono Zon® Ozone Plants

2.4.2 OZONFILT® OZVa 5-7 (Operating Gas - Oxygen)

The OZONFILT® OZVa 5-7 range is a new development based on proven PSG technology producing ozone concentrations of up to 150 g/Nm³ by the use of oxygen as operating gas. Using the designated mixing devices, ozone concentrations in the water to be treated of up to 90 ppm can be achieved (theoretical value at 0 °C).

Depending on the plant type, ozone is produced in 1-3 generators from oxygen provided from special oxygen generators or bottles. The rated output of the individual generators is 30 g/h at 100 g/Nm³.

Type 5 is installed in a wall cabinet similar to OZVa 2; types 6 and 7 are installed in a free-standing cabinet similar to OZVa 4. In all three plants, ozone is transported to the mixing device through a separate 12/10 mm stainless steel pipe or 12/9 mm PTFE pipe.

Operating gas specification

- Oxygen
- Concentration: > 90 vol%
- Dew point: < -50 °C
- Pressure: 3-6 bar

Mixing device

Because of the high ozone concentrations, we recommend mixing systems made of stainless steel. PVC mixing systems may have a reduced service life, depending on the operating conditions.

Notes

- Keep the length of ozone gas transporting pipes and the number of joints to a minimum. Monitor all adjoining rooms with a gas detector in line with the applicable valid German accident prevention regulations. All OZONFILT® plants are equipped for fitting a gas detector such as GMA 36 Ozon.
- Depending on the operating and installation conditions, it might also be necessary to monitor the room air for excessive oxygen content. The GMA 36 Oxygen gas detector can be used for this purpose.
- The ozone generator should be interlocked with the water flow into the metering point on all installations.
- A non-return valve is to be installed upstream of the OZVa to prevent any return of ozonised water into the ozone-transporting pipe.
- All gas-transporting accessories must be resistant to ozone and oxygen (e.g. fat-free).
- Because of the high ozone concentrations, only catalytic residual ozone destructors can be used. Active carbon-based residual ozone destructors ignite spontaneously if subjected to increased ozone concentrations.

Room Air Monitoring see p. → 2-31

2 OZONFILT® and Bono Zon® Ozone Plants

Technical Data

OZONFILT® OZVa 5-7 (operating gas - oxygen)

| | | OZVa 5 | OZVa 6 | OZVa 7 |
|---|-------|-----------------|-----------------|-----------------|
| Number of generator modules | | 1 | 2 | 3 |
| Nominal ozone capacity at 100 g/Nm ³ ** and cooling water at 15 °C | g/h | 30 | 60 | 90 |
| Ozone capacity at 150 g/Nm ³ * | g/h | 17.5 | 35.0 | 52.0 |
| Ozone capacity at 80 g/Nm ³ | g/h | 35 | 70 | 105 |
| Specific energy requirement at nominal capacity | Wh/g | 10 | 10 | 10 |
| Power factor at full capacity | cos φ | 0.98 | 0.98 | 0.98 |
| Ozone connection | | G 1/4" internal | G 1/4" internal | G 1/4" internal |

Electrical connection

| | | OZVa 5 | OZVa 6 | OZVa 7 |
|------------------|--------|-------------|-------------|--------------|
| Connected load | V/Hz/A | 230/50;60/3 | 230/50;60/6 | 230/50;60/10 |
| Enclosure rating | | IP 43 | IP 43 | IP 43 |

Overall dimensions (without mixer)

| | | OZVa 5 | OZVa 6 | OZVa 7 |
|--------|----|--------|--------|--------|
| Width | mm | 865 | 705 | 705 |
| Height | mm | 804 | 1,400 | 1,400 |
| Depth | mm | 310 | 345 | 345 |

Weight

| | | OZVa 5 | OZVa 6 | OZVa 7 |
|--------|----|--------|--------|--------|
| Weight | kg | 75 | 109 | 114 |

Ozone mixing

| | | OZVa 5 | OZVa 6 | OZVa 7 |
|--------------------------------------|-----|---------|---------|---------|
| Max. raw water temperature | °C | 35 | 35 | 35 |
| Permissible pressure at ozone outlet | bar | 0.8–2.0 | 0.8–2.0 | 0.8–2.0 |

Specification of operating gas: oxygen

| | | OZVa 5 | OZVa 6 | OZVa 7 |
|--|------|--------|--------|--------|
| Gas volume at nominal capacity 100 g/Nm ³ | NI/h | 300 | 600 | 900 |
| Gas volume at capacity 150 g/Nm ³ | NI/h | 117* | 234* | 347* |
| Gas volume at capacity 80 g/Nm ³ | NI/h | 438 | 875 | 1,313 |
| Concentration min. | vol% | 90 | 90 | 90 |
| Dew point max. | °C | -50 | -50 | -50 |
| Pressure | bar | 3 – 6 | 3 – 6 | 3 – 6 |
| Max. particles | µm | 5 | 5 | 5 |
| Max. hydrocarbons | ppm | 20 | 20 | 20 |
| Max. temperature | °C | 30 | 30 | 30 |

Cooling water

| | | OZVa 5 | OZVa 6 | OZVa 7 |
|---|-----|--------|--------|--------|
| Cooling water requirement | l/h | 30 | 70 | 100 |
| Cooling water inlet pressure | bar | 1–5 | 1–5 | 1–5 |
| Cooling water inlet, PE pressure hose | mm | 6 x 4 | 6 x 4 | 6 x 4 |
| Cooling water outlet, open discharge | mm | 6 x 4 | 6 x 4 | 6 x 4 |
| Cooling water temperature at ambient temp. max. 35 °C | °C | <30 | <30 | <30 |
| Cooling water temperature at ambient temp. 35–40 °C | °C | <25 | <25 | <25 |

Cooling water quality No tendency to form lime scale. ; Removable substances: < 0.1 ml/l; Iron: < 0.2 mg/l; Manganese: < 0.05 mg/l; no corrosive components; Conductivity: > 100 µS/cm

* Capacity 150 g/Nm³ must be factory set as a special version

** Nm³ = m³ under standard conditions (p = 1.013x10⁵ Pa, T = 273 K)

2 OZONFILT® and Bono Zon® Ozone Plants

2.4.3

Ordering Information for OZONFILT® OZVa Plants

OZONFILT® OZVa 1 capacity 5 g/h

| Type | Control cabinet connection | Order no. |
|---|----------------------------|-----------|
| without mixing system | blue painted | 1004239 |
| without mixing system | stainless steel | 1026124 |
| with transparent mixing system with flow monitoring 0.5–3 m ³ /h | blue painted | 1026118 |
| with transparent mixing system with flow monitoring 0.5–3 m ³ /h | stainless steel | 1026125 |
| with transparent mixing system with flow monitor, 3–5 m ³ /h | blue painted | 1004235 |
| with transparent mixing system with flow monitor, 3–5 m ³ /h | stainless steel | 1026126 |
| with PVCstatic mixer, DN 40, 5–10 m ³ /h | blue painted | 1026120 |
| with PVCstatic mixer, DN 40, 5–10 m ³ /h | stainless steel | 1026127 |
| with PVCstatic mixer, DN 50, 10–15 m ³ /h | blue painted | 1026121 |
| with PVCstatic mixer, DN 50, 10–15 m ³ /h | stainless steel | 1026128 |
| with PVCstatic mixer, DN 32, 0.5–2.8 m ³ /h | blue painted | 1026122 |
| with PVCstatic mixer, DN 32, 0.5–2.8 m ³ /h | stainless steel | 1026129 |
| with PVCstatic mixer, DN 32, 2.8–5 m ³ /h | blue painted | 1026123 |
| with PVCstatic mixer, DN 32, 2.8–5 m ³ /h | stainless steel | 1026130 |

OZONFILT® OZVa 2 capacity 15 g/h

| Type | Control cabinet connection | Order no. |
|---|----------------------------|-----------|
| without mixing system | blue painted | 1005129 |
| without mixing system | stainless steel | 1026133 |
| with PVC static mixer, DN 40, 5–10 m ³ /h | blue painted | 1005127 |
| with PVC static mixer, DN 40, 5–10 m ³ /h | stainless steel | 1026134 |
| with PVC static mixer, DN 50, 10–15 m ³ /h | blue painted | 1005806 |
| with PVC static mixer, DN 50, 10–15 m ³ /h | stainless steel | 1026135 |
| with PVC static mixer, DN 32, 0.5–2.8 m ³ /h | blue painted | 1026132 |
| with PVC static mixer, DN 32, 0.5–2.8 m ³ /h | stainless steel | 1026144 |
| with PVC static mixer, DN 32, 2.8–5 m ³ /h | blue painted | 1005125 |
| with PVC static mixer, DN 32, 2.8–5 m ³ /h | stainless steel | 1026145 |

OZONFILT® OZVa 3 capacity 35 g/h

| Type | Control cabinet connection | Order no. |
|-----------------------|----------------------------|-----------|
| without mixing system | blue painted | 1009083 |
| without mixing system | stainless steel | 1026146 |

OZONFILT® OZVa 4 capacity 40 g/h

| Type | Control cabinet connection | Order no. |
|-----------------------|----------------------------|-----------|
| without mixing system | blue painted | 1009105 |
| without mixing system | stainless steel | 1026147 |

2 OZONFILT® and Bono Zon® Ozone Plants

OZONFILT® OZVa 5 capacity 30 g/h operating gas oxygen

| Type | Control cabinet connection | Order no. |
|-----------------------|----------------------------|-----------|
| without mixing system | blue painted | 1026148 |
| without mixing system | stainless steel | 1026149 |

OZONFILT® OZVa 6 capacity 60 g/h operating gas oxygen

| Type | Control cabinet connection | Order no. |
|-----------------------|----------------------------|-----------|
| without mixing system | blue painted | 1023452 |
| without mixing system | stainless steel | 1026150 |

OZONFILT® OZVa 7 capacity 90 g/h operating gas oxygen

| Type | Control cabinet connection | Order no. |
|-----------------------|----------------------------|-----------|
| without mixing system | blue painted | 1026151 |
| without mixing system | stainless steel | 1026152 |

2

2 OZONFILT® and Bono Zon® Ozone Plants

2.4.4 OZONFILT® Compact OMVa

The OZONFILT® Compact OMVa is a complete, fully-assembled, ready for use ozone stage for the treatment of potable water, service water or swimming pool water in the capacity range from 5...40 g ozone/h, and consists of the following modules:

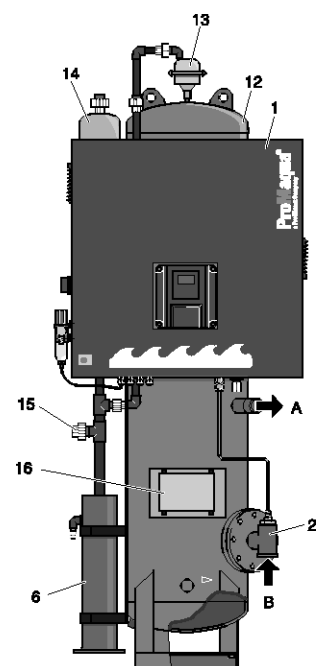

pk_7_024_V2

A to filtration
B Raw water

Ozone generation module (1), built in accordance with DIN 19627:

The ozone is produced with an OZONFILT® OZVa in a pressure-resistant ozone generator using an electronically produced and controlled medium-frequency voltage.

Ozone mixing module (2):

This module consists of an ozone metering point and a downstream mixing section made of stainless steel, with a series of static mixing elements for intensive mixing of the ozone/air mix with the water to be treated. The pipelines carrying the ozone, and the pipeline from the raw water connection to the entry to the reaction tank are fabricated totally in stainless steel and have been factory pressure tested.

With back pressures of up to max. 1.8 bar, no injector is required to suck out the ozone, as the ozone production takes place at positive pressure.

Reaction tank module (12):

The stainless steel reaction tank incorporates all the necessary fittings for water distribution and an automatic bleed valve (13). The ozone generation module (1), the residual ozone gas destructor (14) and room air monitoring (16) are mounted on this tank (12).

Residual ozone gas destruction module (14):

The residual ozone gas destruction module (14) incorporates an integrated water separator, (6) to remove traces of ozone gas in the exhaust air coming from the reaction tank (12). A connection is also available for the exhaust air from any downstream filter plant (15) that may be fitted.

Room air monitoring module (16):

The room air is monitored for traces of ozone gas by a calibrated gas warning device with an electrochemical sensor with good long-term stability.

If the alarm threshold is exceeded, ozone production is stopped and an alarm emitted. A buzzer is activated at the same time.

Technical Data

| Type | | OMVa 5-200 | OMVa 15-500 | OMVa 35-1,000 |
|-------------------------------|-------------------|-------------------|-------------------|-----------------------|
| Ozone capacity | g/h | 5 | 15 | 35 |
| Reaction tank volume | l | 205 | 460 | 1,080 |
| Typical flow rate | m ³ /h | 5 – 10 | 10 – 15 | 25 – 35 |
| Operating pressure | bar | 0.6 – 1.8 | 0.6 – 1.8 | 0.6 – 1.8 |
| Reaction tank connection size | | DN 40 | DN 50 | DN 80 |
| Dimensions H x W x D | mm | 2,000 x 850 x 760 | 2,200 x 850 x 760 | 2,600 x 1,100 x 1,160 |
| Weight | kg | 200 | 250 | 350 |
| Connected load | V/Hz/A | 230/50;60/2 | 230/50;60/3 | 230/50;60/6 |

All features of the three standard versions can be adapted to specific project-related customer requirements.

2 OZONFILT® and Bono Zon® Ozone Plants

2.5

OZONFILT® OZMa

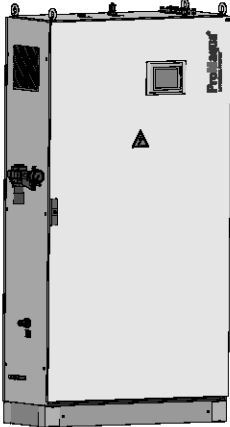

P_PMA_OF_0010_SW

OZMa® ozone systems are designed as pressure systems which generate ozone using compressed air or oxygen through the use of medium-frequency high voltage. The electronic power unit offers complete protection for the electrical components (high-voltage transformer and power stage) and also permits the correct digital display of the ozone output in "gram/hour". As a result, any required ozone volume between 3 and 100 % of the nominal capacity can be set reproducibly and largely independently of voltage and pressure fluctuations.

The use of an integrated, self optimising (dynamic) variable pressure swing dryer ensures minimum compressed air consumption of the air systems. The use of a dielectric with optimum thermal conductivity results in an exceptionally compact system design and minimum energy consumption. The unique construction of the generator ensures outstanding cooling performance with low cooling water consumption whilst quickly removing the heat produced before the ozone produced can decompose due to excessive heat.

Simple and safe operation is ensured by the industry standard programmable logic controller (PLC) and clearly arranged touch panel with data logger and screen recorder. A PROFIBUS® DP communication interface ensures ease of integration into industrial control systems. Remote diagnostics and communication are optionally available via a LAN communication interface.

The automatic control of the gas flow ensures the concentration of the ozone in the gas flow is maintained constant, independently of ozone volume transported. This reduces the quantity of operating gas to a minimum and ensures constant ozone solubility.

An ozone sensor can be directly connected to the ozone measuring and control device integrated in the PLC. Thus, the ozone fed to the water can be monitored and the ozone output directly controlled.

Operation under pressure means that the ozone generated can be introduced directly into water systems with back pressures of up to 2 bar. Additional booster pumps and injectors can therefore be dispensed with in many applications.

Features

- Simple installation thanks to compact design and single-phase power supply
- Low compressed air consumption thanks to a dynamic pressure swing dryer with low priming pressure (air systems) and demand-dependent regeneration matched to the individual conditions in-situ
- Minimum power and cooling water consumption thanks to new, maintenance-free generator concept
- Electronic power unit with automatic ozone generation largely independent of voltage and pressure fluctuations. Thus maximum error tolerance with regard to influences from installation environment
- Infinitely variable adjustment of any desired ozone quantity between 3 and 100 % of rated output
- PLC with integrated ozone measurement and control
- 5.7" touch panel with data logger and screen recorder
- PROFIBUS® DP communications interface (optionally LAN)
- Easy integration of customer-specific control requirements
- Automatic control of the gas volume flow ensures minimum process gas consumption at constant ozone concentration

2 OZONFILT® and Bono Zon® Ozone Plants

2.5.1

OZONFILT® OZMa 1-6 A Ozone Generation Plants (Operating Gas - Air)

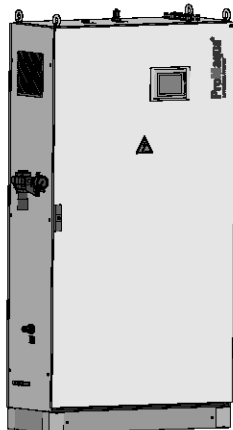

P_PMA_OF_0010_SW

Under nominal conditions, the OZMa 1-6 A range produces up to 420 g/h of ozone from compressed air at a concentration of 20 g/Nm³. Using the designated mixing devices, ozone concentrations of between 3 and 12 ppm can be achieved in the water to be treated, depending on the temperature (theoretical value at 30 or 0 °C).

Different feature options can be achieved by combining different Identcode characteristics.

The plants are pre-mounted ready for connection in a painted steel cabinet (optional stainless steel control cabinet) and need only be connected to a single-phase voltage supply, compressed air, cooling water/waste water and ozone metering point on the customer's site.

An adequate compressed air supply and a mixing device designed for the operating conditions should be integrated.

Order Information For OZONFILT® OZMa Plants see p. → 2-20,
Static Helical Mixer Made Of PVC Or Stainless Steel see p. → 2-26

Requirements relating to the compressed air supply

- Oil and dust-free, non-corrosive, constant upstream pressure of 4.5 - 10 bar
- Required air quantity:
 - OZMa 1 A: 73 l/min
 - OZMa 2 A: 110 l/min
 - OZMa 3 A: 147 l/min
 - OZMa 4 A: 220 l/min
 - OZMa 5 A: 293 l/min
 - OZMa 6 A: 440 l/min

Mixing device

All OZMa plants are in principle delivered without mixing device and a suitable mixing system should be ordered separately. When selecting a suitable mixing device, please note that the mixing of ozone is more efficient the higher the water flow in the mixing system. The mixing system should therefore be designed so that the flow of the water to be treated is at the upper range of the flow specification.

Static Helical Mixer Made From PVC Or Stainless Steel see p. → 2-26

Notes on installation

Keep the length of ozone gas transporting pipes and the number of joints to a minimum. All rooms with a removable joint should be monitored with a gas detector in line with the applicable German accident prevention regulations. All OZONFILT® plants are equipped for fitting a gas detector such as GMA 36 Ozon.

Ozonisation adds a large amount of gas to the water of which only a small percentage can dissolve. Adequate bleeding should therefore be integrated. Because the gases discharged in this way have a considerable residual ozone concentration, appropriate residual ozone destructors should be installed.

The ozone generator should be interlocked with the water flow into the metering point for all installations.

A non-return valve should be installed between OZMa and the ozone metering point.

Room Air Monitoring see p. → 2-31, Residual Ozone Gas Destructor see p. → 2-30

2 OZONFILT® and Bono Zon® Ozone Plants

Technical Data

OZONFILT® OZMa 1-3 A ozone generation plants (process gas - air)

Ambient parameters

max. 85 % relative humidity of ambient air, non-condensing, non-corrosive, dust-free, max. ambient temperature: 40 °C

| | | OZMa 1A | OZMa 2A | OZMa 3A |
|--|---------------------|-----------------|-----------------|-----------------|
| Number of generator modules | | 1 | 1 | 1 |
| Ozone capacity, measured in accordance with DIN with air at 20 °C, cooling water at 15 °C | g/h | 70 | 105 | 140 |
| Air consumption (only ozone generation) | Nm ³ /h | 3.50 | 5.25 | 7.00 |
| Ozone concentration in the gas phase referenced to nominal conditions | g/Nm ³ * | 20 | 20 | 20 |
| Specific energy requirement at nominal capacity | Wh/g | 16.5 | 16.5 | 16.5 |
| Power factor at full capacity | cos φ | 0.95 | 0.95 | 0.95 |
| Ozone connection | | G 3/8" internal | G 3/8" internal | G 3/8" internal |

* Nm³= m³at standard conditions (P = 1.013x10⁵Pa, T = 273 K)

Electrical connection

| | | OZMa 1A | OZMa 2A | OZMa 3A |
|-------------------------|--------|--------------|--------------|--------------|
| Connected load | V/Hz/A | 230/50;60/10 | 230/50;60/16 | 230/50;60/16 |
| Enclosure rating | | IP 43 | IP 43 | IP 43 |

Overall dimensions (without mixer)

| | | OZMa 1A | OZMa 2A | OZMa 3A |
|---------------|----|---------|---------|---------|
| Width | mm | 1,114 | 1,114 | 1,114 |
| Height | mm | 1,961 | 1,961 | 1,961 |
| Depth | mm | 405 | 405 | 405 |

Weight

| | | OZMa 1A | OZMa 2A | OZMa 3A |
|---------------|----|---------|---------|---------|
| Weight | kg | 270 | 280 | 300 |

Ozone mixing

| | | OZMa 1A | OZMa 2A | OZMa 3A |
|---|-----|---------|---------|---------|
| Max. raw water temperature | °C | 35 | 35 | 35 |
| Permissible pressure at ozone outlet | bar | 0.8–2.0 | 0.8–2.0 | 0.8–2.0 |

Air supply

| | | OZMa 1A | OZMa 2A | OZMa 3A |
|------------------------------|--------|---------|---------|---------|
| Required air quantity | NI/min | 73 | 110 | 147 |

Air quality

Oil- and dust-free, Non-corrosive, Constant upstream pressure of 4.5 - 10 bar

Cooling water

| | | OZMa 1A | OZMa 2A | OZMa 3A |
|--|-----|---------|---------|---------|
| Cooling water consumption (15 °C) | l/h | 90 | 135 | 180 |
| Cooling water consumption (30 °C) | l/h | 200 | 300 | 400 |
| Cooling water inlet pressure | bar | 2–5 | 2–5 | 2–5 |
| Cooling water inlet, PE pressure hose | mm | 8 x 5 | 8 x 5 | 12 x 9 |
| Cooling water outlet, open discharge | mm | 8 x 5 | 8 x 5 | 12 x 9 |

Cooling water quality

No tendency to form lime scale; Removable substances: < 0.1 ml/l ; Iron: < 0.2 mg/l; Manganese: < 0.05 mg/l; no corrosive components; Conductivity: > 100 µS/cm

2 OZONFILT® and Bono Zon® Ozone Plants

OZONFILT® OZMa 4-6 A ozone generation plants (process gas - air)

Ambient parameters

max. 85 % relative humidity of ambient air, non-condensing, non-corrosive, dust-free,
max. ambient temperature: 40 °C

| | | OZMa 4A | OZMa 5A | OZMa 6A |
|--|---------------------|-----------------|-----------------|-----------------|
| Number of generator modules | | 2 | 2 | 3 |
| Ozone capacity, measured in accordance with DIN with air at 20 °C, cooling water at 15 °C | g/h | 210 | 280 | 420 |
| Air consumption (only ozone generation) | Nm ³ /h | 10.50 | 14.00 | 21.00 |
| Ozone concentration in the gas phase referenced to nominal conditions | g/Nm ³ * | 20 | 20 | 20 |
| Specific energy requirement at nominal capacity | Wh/g | 16.5 | 16.5 | 16.5 |
| Power factor at full capacity | cos φ | 0.95 | 0.95 | 0.95 |
| Ozone connection | | G 3/8" internal | G 3/8" internal | G 3/8" internal |

* Nm³= m³at standard conditions (P = 1.013x10⁵Pa, T = 273 K)

Electrical connection

| | | OZMa 4A | OZMa 5A | OZMa 6A |
|-------------------------|--------|--------------|--------------|--------------|
| Connected load | V/Hz/A | 400/50;60/16 | 400/50;60/16 | 400/50;60/16 |
| Enclosure rating | | IP 43 | IP 43 | IP 43 |

Overall dimensions (without mixer)

| | | OZMa 4A | OZMa 5A | OZMa 6A |
|---------------|----|---------|---------|---------|
| Width | mm | 1,320 | 1,320 | 1,606 |
| Height | mm | 1,961 | 1,961 | 1,961 |
| Depth | mm | 605 | 605 | 605 |

Weight

| | | OZMa 4A | OZMa 5A | OZMa 6A |
|---------------|----|---------|---------|---------|
| Weight | kg | 420 | 445 | 589 |

Ozone mixing

| | | OZMa 4A | OZMa 5A | OZMa 6A |
|---|-----|---------|---------|---------|
| Max. raw water temperature | °C | 35 | 35 | 35 |
| Permissible pressure at ozone outlet | bar | 0.8–2.0 | 0.8–2.0 | 0.8–2.0 |

Air supply

| | | OZMa 4A | OZMa 5A | OZMa 6A |
|------------------------------|--------|---------|---------|---------|
| Required air quantity | NI/min | 220 | 293 | 440 |

Air quality

Oil- and dust-free, Non-corrosive, Constant upstream pressure of 4.5 - 10 bar

Cooling water

| | | OZMa 4A | OZMa 5A | OZMa 6A |
|--|-----|---------|---------|---------|
| Cooling water consumption (15 °C) | l/h | 270 | 360 | 540 |
| Cooling water consumption (30 °C) | l/h | 600 | 800 | 1,200 |
| Cooling water inlet pressure | bar | 2–5 | 2–5 | 2–5 |
| Cooling water inlet, PE pressure hose | mm | 12 x 9 | 12 x 9 | 12 x 9 |
| Cooling water outlet, open discharge | mm | 12 x 9 | 12 x 9 | 12 x 9 |

Cooling water quality

No tendency to form lime scale; Removable substances: < 0.1 ml/l ; Iron: < 0.2 mg/l; Manganese: < 0.05 mg/l; no corrosive components; Conductivity: > 100 µS/cm

2 OZONFILT® and Bono Zon® Ozone Plants

2.5.2

OZONFILT® OZMa 1-6 O Ozone Generation Plants (Operating Gas - Oxygen)

Under nominal conditions, the OZMa 1-6 O range produces up to 735 g/h of ozone from oxygen at a concentration of up to 150 g/Nm³. Using the designated mixing devices, ozone concentrations in the water to be treated of up to 90 ppm can be achieved (theoretical value at 0 °C). Ozone concentration in g/Nm³ and system feed rate in g/h can be varied depending on the operating conditions and can thus be individually matched to the application conditions. Examples for various combinations are listed in the technical data table.

Different feature options can be achieved by combining different Identcode characteristics.

The plants are pre-mounted ready for connection in a painted steel cabinet (optional stainless steel control cabinet) and should only be connected to a single-phase voltage supply, oxygen, cooling water/waste water and ozone metering point on the customer's site.

Order Information For OZONFILT® OZMa Plants see p. → 2-20

Requirements relating to the oxygen supply

- See technical data
- Required gas quantities: see technical data

Mixing device

All OZMa plants are in principle delivered without a mixing device, a suitable mixing system should be ordered separately. When selecting a suitable mixing device, please note that the mixing of ozone is more efficient the higher the water flow in the mixing system. The mixing system should thus be designed so that the flow of water to be treated is at the upper range of the flow specification.

We recommend mixing systems made of stainless steel because of the high ozone concentrations.. Mixing systems made of PVC may have a reduced service life, depending on the operating conditions.

Static Helical Mixer Made From PVC Or Stainless Steel see p. → 2-26

Notes on installation

The length of ozone gas transporting pipes and the number of joints to a minimum. All rooms with a removable joint should be monitored with a gas detector in line with the applicable German accident prevention regulations. All OZONFILT® plants are equipped for fitting a gas detector such as GMA 36 Ozon.

Depending on the operating and installation conditions, it might be necessary to also monitor the room air for excessive oxygen content. The gas detector GMA 36 Oxygen can be used.

All gas-transporting accessories should be resistant to ozone and oxygen (e.g. fat-free).

Ozonisation adds a large amount of gas to the water of which only a small percentage can dissolve. Adequate bleeding should therefore be integrated. Because the gases discharged this way have a considerable residual ozone concentration, appropriate residual ozone destructors should be installed. Because of the high ozone concentrations, only catalytic residual ozone destructors can be used. Active carbon-based residual ozone destructors ignite spontaneously if subjected to increased ozone concentrations.

The ozone generator must be interlocked with the water flow into the metering point for all installation..

A non-return valve should be installed between OZMa and ozone metering point to prevent any return of ozonised water into the ozone-transporting pipe..

Room Air Monitoring see p. → 2-31, Residual Ozone Gas Destructor see p. → 2-30

2 OZONFILT® and Bono Zon® Ozone Plants

Technical Data

OZONFILT® OZMa 1-3 O ozone generation plants (process gas - oxygen)

| | | OZMa 1 O | OZMa 2 O | OZMa 3 O |
|---|-------|-----------------|-----------------|-----------------|
| Number of generator modules | | 1 | 1 | 1 |
| Nominal ozone capacity at 100 g/Nm ³ ** and cooling water at 15 °C | g/h | 105 | 158 | 210 |
| Ozone capacity at 150 g/Nm ³ * | g/h | 60 | 90 | 120 |
| Ozone capacity at 80 g/Nm ³ | g/h | 123 | 184 | 245 |
| Specific energy requirement at nominal capacity | Wh/g | 9 | 9 | 9 |
| Power factor at full capacity | cos φ | 0.95 | 0.95 | 0.95 |
| Ozone connection | | G 3/8" internal | G 3/8" internal | G 3/8" internal |

Electrical connection

| | | OZMa 1 O | OZMa 2 O | OZMa 3 O |
|------------------|--------|--------------|--------------|--------------|
| Connected load | V/Hz/A | 230/50;60/10 | 230/50;60/16 | 230/50;60/16 |
| Enclosure rating | | IP 43 | IP 43 | IP 43 |

Overall dimensions

| | | OZMa 1 O | OZMa 2 O | OZMa 3 O |
|--------|----|----------|----------|----------|
| Width | mm | 1,114 | 1,114 | 1,114 |
| Height | mm | 1,961 | 1,961 | 1,961 |
| Depth | mm | 400 | 400 | 400 |

Weight

| | | OZMa 1 O | OZMa 2 O | OZMa 3 O |
|--------|----|----------|----------|----------|
| Weight | kg | 220 | 230 | 250 |

Ozone mixing

| | | OZMa 1 O | OZMa 2 O | OZMa 3 O |
|--------------------------------------|-----|----------|----------|----------|
| Raw water temperature max. | °C | 35 | 35 | 35 |
| Permissible pressure at ozone outlet | bar | 0.8–2.0 | 0.8–2.0 | 0.8–2.0 |

Specification of operating gas: oxygen

| | | OZMa 1 O | OZMa 2 O | OZMa 3 O |
|--|------|----------|----------|----------|
| Gas volume at nominal capacity 100 g/Nm ³ | NI/h | 1,050 | 1,580 | 2,100 |
| Gas volume at capacity 150 g/Nm ³ | NI/h | 400* | 600* | 800* |
| Gas volume at capacity 80 g/Nm ³ | NI/h | 1,540 | 2,300 | 3,100 |
| Concentration min. | vol% | 90 | 90 | 90 |
| Dew point max. | °C | -50 | -50 | -50 |
| Pressure | bar | 3 – 6 | 3 – 6 | 3 – 6 |
| Max. particles | µm | 5 | 5 | 5 |
| Max. hydrocarbons | ppm | 20 | 20 | 20 |
| Max. temperature | °C | 30 | 30 | 30 |

Cooling water

| | | OZMa 1 O | OZMa 2 O | OZMa 3 O |
|---------------------------------------|-----|----------|----------|----------|
| Cooling water consumption (15 °C) | l/h | 120 | 180 | 240 |
| Cooling water consumption (30 °C) | l/h | 200 | 300 | 400 |
| Cooling water inlet pressure | bar | 1–5 | 1–5 | 1–5 |
| Cooling water inlet, PE pressure hose | mm | 8 x 5 | 8 x 5 | 12 x 9 |
| Cooling water outlet, open discharge | mm | 8 x 5 | 8 x 5 | 12 x 9 |

Cooling water quality No tendency to form lime scale, no corrosive components; Sedimentable substances: < 0.1 ml/l; Iron: < 0.2mg/l; Manganese: < 0.05 mg/l; Conductivity: > 100 µS/cm; Chloride: < 250 mg/l

* Output 150 g/Nm³ as special version must be factory-set

** Nm³ = m³ at standard conditions (P = 1.013x10⁵Pa, T = 273 K)

2 OZONFILT® and Bono Zon® Ozone Plants

OZONFILT® OZMa 4-6 O ozone generation plants (operating gas - oxygen)

| | | OZMa 4 O | OZMa 5 O | OZMa 6 O |
|---|-------|-----------------|-----------------|-----------------|
| Number of generator modules | | 2 | 2 | 3 |
| Nominal ozone capacity at 100 g/Nm ³ ** and cooling water at 15 °C | g/h | 320 | 420 | 630 |
| Ozone capacity at 150 g/Nm ³ * | g/h | 180 | 240 | 360 |
| Ozone capacity at 80 g/Nm ³ | g/h | 370 | 490 | 735 |
| Specific energy requirement at nominal capacity | Wh/g | 9 | 9 | 9 |
| Power factor at full capacity | cos φ | 0.95 | 0.95 | 0.95 |
| Ozone connection | | G 3/8" internal | G 3/8" internal | G 3/8" internal |

Electrical connection

| | | OZMa 4 O | OZMa 5 O | OZMa 6 O |
|------------------|--------|--------------|--------------|--------------|
| Connected load | V/Hz/A | 400/50;60/16 | 400/50;60/16 | 400/50;60/16 |
| Enclosure rating | | IP 43 | IP 43 | IP 43 |

Overall dimensions

| | | OZMa 4 O | OZMa 5 O | OZMa 6 O |
|--------|----|----------|----------|----------|
| Width | mm | 1,320 | 1,320 | 1,320 |
| Height | mm | 1,961 | 1,961 | 1,961 |
| Depth | mm | 605 | 605 | 605 |

Weight

| | | OZMa 4 O | OZMa 5 O | OZMa 6 O |
|--------|----|----------|----------|----------|
| Weight | kg | 320 | 345 | 415 |

Ozone mixing

| | | OZMa 4 O | OZMa 5 O | OZMa 6 O |
|--------------------------------------|-----|----------|----------|----------|
| Max. raw water temperature | °C | 35 | 35 | 35 |
| Permissible pressure at ozone outlet | bar | 0.8–2.0 | 0.8–2.0 | 0.8–2.0 |

Specification of operating gas: oxygen

| | | OZMa 4 O | OZMa 5 O | OZMa 6 O |
|--|------|----------|----------|----------|
| Gas volume at nominal capacity 100 g/Nm ³ | NI/h | 3,200 | 4,200 | 6,300 |
| Gas volume at capacity 150 g/Nm ³ | NI/h | 1,200* | 1,600* | 2,400* |
| Gas volume at capacity 80 g/Nm ³ | NI/h | 4,630 | 6,130 | 9,190 |
| Concentration min. | vol% | 90 | 90 | 90 |
| Dew point max. | °C | -50 | -50 | -50 |
| Pressure | bar | 3 – 6 | 3 – 6 | 3 – 6 |
| Max. particles | µm | 5 | 5 | 5 |
| Max. hydrocarbons | ppm | 20 | 20 | 20 |
| Max. temperature | °C | 30 | 30 | 30 |

Cooling water

| | | OZMa 4 O | OZMa 5 O | OZMa 6 O |
|---------------------------------------|-----|----------|----------|----------|
| Cooling water consumption (15 °C) | l/h | 200 | 280 | 420 |
| Cooling water consumption (30 °C) | l/h | 330 | 470 | 700 |
| Cooling water inlet pressure | bar | 1–5 | 1–5 | 1–5 |
| Cooling water inlet, PE pressure hose | mm | 12 x 9 | 12 x 9 | 12 x 9 |
| Cooling water outlet, open discharge | mm | 12 x 9 | 12 x 9 | 12 x 9 |

Cooling water quality No tendency to form lime scale, no corrosive components; Sedimentable substances: < 0.1 ml/l; Iron: < 0.2mg/l; Manganese: < 0.05 mg/l; Conductivity: > 100 µS/cm; Chloride: < 250 mg/l

* Output 150 g/Nm³ as special version must be factory-set

** Nm³ = m³ at standard conditions (P = 1.013x10⁵ Pa, T = 273 K)

2 OZONFILT® and Bono Zon® Ozone Plants

2.5.3 Order Information for OZONFILT® OZMa Plants

| OZMa | | Type ozone generator | |
|---------------------------------|--|---|------------------|
| | | Air operation | Oxygen operation |
| | | g/h | g/h |
| 01 | | 70 | 105 |
| 02 | | 105 | 158 |
| 03 | | 140 | 210 |
| 04 | | 210 | 320 |
| 05 | | 280 | 420 |
| 06 | | 420 | 630 |
| Operating gas | | | |
| A | | Operating gas - air | |
| O | | Operating gas - oxygen | |
| Type | | | |
| P | | ProMaqua | |
| S | | Special version | |
| Mechanical design | | | |
| 0 | | Standard (packaging for transport by HGV) | |
| 1 | | Standard (packaging for sea/air freight) | |
| 2 | | In stainless steel cabinet (packaging for transport by HGV) | |
| 3 | | In stainless steel cabinet (packaging for sea/air freight) | |
| M | | Modified | |
| Operating voltage | | | |
| A | | Single-phase 230 V ±10 %, 50/60 Hz (only types 01-03) | |
| S | | Three-phase 230/400 V ±10 %, 50/60 Hz (only types 04-06) | |
| Gas treatment | | | |
| 0 | | Gas treatment not integrated (design operating gas - oxygen) | |
| 1 | | Gas treatment integrated without filter package (design operating gas - air) | |
| 2 | | Gas treatment integrated with filter package (design operating gas - air) | |
| 3 | | Gas treatment not integrated (oxygen operating gas version), including gas control valve | |
| 4 | | Gas treatment integrated without filter package (air operating gas version), including gas control valve | |
| 5 | | Gas treatment integrated with filter package (air operating gas version), including gas control valve | |
| Preset language | | | |
| DE | | German | |
| EN | | English | |
| FR | | French | |
| IT | | Italian | |
| ES | | Spanish | |
| Control | | | |
| 0 | | Basic version with digital input to control two power stages | |
| 1 | | External power control via 0/4-20 mA input, data logger | |
| 2 | | External power control, ozone measurement and visualisation via screen recorder, 2 freely configurable 0/4-20 mA inputs, 1 freely configurable 0/4-20 mA output | |
| 3 | | As 2 with additionally integrated PID controller for control of the ozone concentration independent of measured value and flow | |
| Communication interfaces | | | |
| 0 | | None | |
| 4 | | PROFIBUS® DP interface | |
| Additional options | | | |
| 0 | | None | |
| 1 | | Dew point sensor | |
| Approvals | | | |
| 01 | | CE-mark | |
| Hardware | | | |
| 0 | | Standard | |
| Software | | | |
| 0 | | Standard | |

Explanations on the Identcode:

- Mechanical design: In design 0 and 1, the plant is installed in a standard control cabinet made of powder-coated steel.
- Gas treatment: Without filter package for oil-free generated or de-oiled compressed air.
With filter package for compressed air with residual oil content.

2 OZONFILT® and Bono Zon® Ozone Plants

2.6 Bono Zon® Ozone Plants

BONa range: capacity range 80-720 g/h

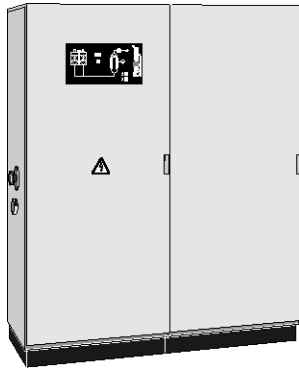

pk_7_002_V2
BONa 2A, capacity 160 g/h

BONa systems are designed as vacuum systems and so comply with the highest safety measures. A clear, easy to read display panel provides information on air flow, voltage, power consumption and the air treatment status.

The ozone capacity can be continuously adjusted over the entire capacity range. The entire process control and monitoring of safety-related parameters is done with the aid of the integrated PLC.

Minimal operating costs are achieved through load-dependent regeneration of the air treatment system and a significant reduction in the cooling water requirement.

Bono Zon® systems comply with the German standard for ozone generation systems, DIN 19 627.

Bono Zon® systems are fitted with a reliable and economic adsorber drier. The load-dependent control of adsorber regeneration ends the heating phase when the breakdown temperature is reached. The required dew point is continually ensured and operating costs are simultaneously minimised. This ensures optimum operational safety of the ozone system.

The control for the booster pump and the protection device are integrated in the electrical cabinet of the BONa system.

Features

- Ozone generation modules made of stainless steel
- Automatic electronic overload detection linked to safety disconnection, even during partial load operation
- The Siemens® Simatic S7 PLC controls all process sequences and issues fault messages if anomalies occur.
- Clear, easy to understand display and operating panel: the ozone generation sequence is displayed on the flow diagram. LED displays inform the operator of the current operating status and the set values, e.g. volume flow (process gas), primary voltage and primary current are displayed.
- Ozone generators that have been optimised for minimum power consumption. Power requirement 18.7 Wh/g.
- Continuous adjustment of ozone generation to demand through use of a regulating transformer that can be fitted with an electric actuator if required.
- Direct connection of our DULCOTEST® OZE ozone measuring sensor is possible.
- The booster pump control and fuse are already integrated in the electrical cabinet.
- Clear, easy to read display area with operating and fault lamps and digital measuring instruments integrated in a display panel.
- Vacuum operation ensures the highest possible protection against ozone leaks.
- Air treatment using cost-effective adsorber drier. An optimum dew point is ensured by means of thermostatically-controlled regeneration.
- Bono Zon® systems comply with the German standard for ozone generation systems, DIN 19627.

Nominal ozone concentration

20 g/m³ (based on standard conditions, p=1.013x10⁵ Pa, T=273 K), measured with a cooling water temperature of 15 °C max., at an ambient air temperature of 20 °C max.

Design conditions in accordance with DIN 19627

Max. 30 °C; 60 % rel. humidity, dust-free installation, no aggressive gases, supply and extract air ventilation of the installation room.

An air conditioning system may be required with elevated ambient temperature and/or humidity at the installation position of the plant. Please specify separately at time of ordering! Suitable measures (e.g. air conditioning of the installation room) should be taken to prevent condensation forming, even when the plant is shut down.

Standard values for cooling water quality:

- Temperature < 25 °C
- Replaceable substances < 0.1 ml/l
- Iron < 0.2 mg/l
- Manganese < 0.05 mg/l
- Chloride < 250 mg/l (BONa D und E)
- No tendency to form lime deposits
- No corrosive components

2 OZONFILT® and Bono Zon® Ozone Plants

Design

For optimum operation of a water treatment system using ozone, it is essential that all components are carefully matched with each other:

- **Ozone generation:**
Selection of a suitable ozone plant is not just determined by the required quantity of ozone/hour but also by other limiting conditions such as the nature and temperature of the cooling water and the environmental conditions, etc.
- **Mixing:**
First and foremost, the parameters of the water to be treated, such as flow rate, back pressure, etc. are required for design of the mixing system.
- **Reaction tank:**
Whether a reaction tank is required, and if so, what size and equipment is required, depends primarily on the requirements of the particular application.
- **Residual ozone destruction:**
Similarly, the choice of the suitable ozone destructor is determined by the ozonisation application. As an example, no catalytic residual ozone destructors can be used in the swimming pool, because of their sensitivity to chlorine.

The diagram below shows a typical arrangement of an ozone treatment system. For each ozone project, our project engineers combine all the right components to meet specific customer requirements.

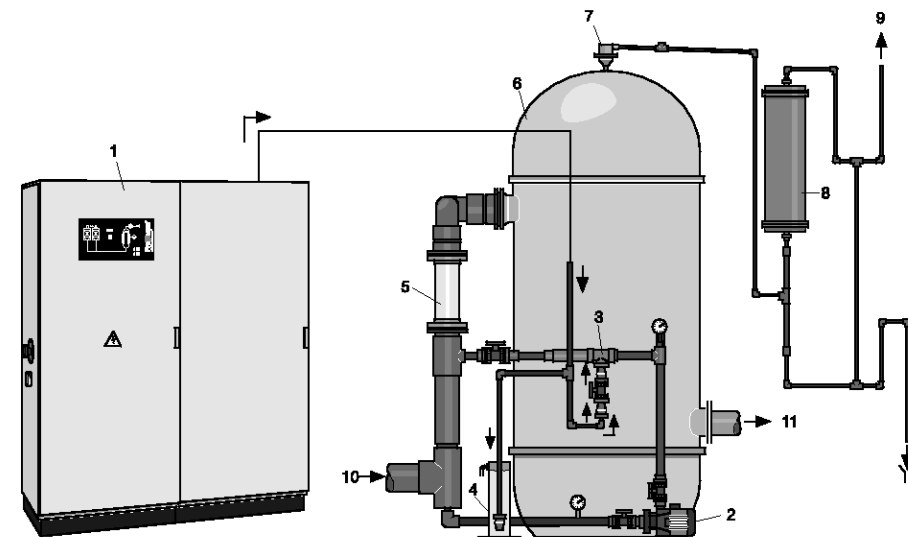

pk_7_003_1

- 1 Ozone plant type BONA
- 2 Booster pump
- 3 Injector system
- 4 Water trap
- 5 Mixer
- 6 Reaction tank
- 7 Bleed valve
- 8 Residual ozone destructor
- 9 Ozone-free exhaust air
- 10 Raw water
- 11 Ozonised water

BONA ozone production plant with mixing device, reaction tank and residual ozone destruction

2 OZONFILT® and Bono Zon® Ozone Plants

2.6.1 Bono Zon® Ozone Plant with Stainless Steel Ozone Generator

Depending on capacity, the ozone plants in this range are equipped with 1 – 9 ozone generators made from stainless steel. Indirect cooling of the dielectrics eliminates the possibility of cooling water ingress. Individual electrodes can be easily replaced without the need to empty the entire reactor. This ensures a high level of reliability and makes the plant very service-friendly.

The operating pressure of the ozone generator is –0.08 to 0 bar and should be produced with an injector system matched to the particular application.

Ozone generators made of PVC are optionally available for use with corrosive cooling water.

Technical Data

Bono Zon® ozone plant with Stainless Steel Ozone Generator

| Type | | 1D | 2E | 2D | 3D | 4D | 5D | 6D | 7D | 8D | 9D |
|---|-------------------|-------|-------|-------|-------|-------|-------|-------|-------|-------|-------|
| Number of generator modules | | 1 | 2 | 2 | 3 | 4 | 5 | 6 | 7 | 8 | 9 |
| Ozone capacity, measured in accordance with DIN, with air 20°C, cooling water 15°C | g/h | 80 | 120 | 160 | 240 | 320 | 400 | 480 | 560 | 640 | 720 |
| Air flow for ozone production max. | m ³ /h | 4 | 6 | 8 | 12 | 16 | 20 | 24 | 28 | 32 | 36 |
| Ozone generation power consumption (without air treatment) | kW | 1.5 | 2.2 | 3.0 | 4.5 | 6.0 | 7.5 | 9.0 | 10.5 | 12.0 | 13.5 |
| Ozone connection | | DN 15 | DN 20 | DN 20 | DN 32 | DN 32 | DN 32 | DN 40 | DN 40 | DN 40 | DN 50 |

Cooling water

| Type | | 1D | 2E | 2D | 3D | 4D | 5D | 6D | 7D | 8D | 9D |
|--|-------------------|-------|-------|-------|-------|-------|-------|-------|-------|-------|-------|
| Cooling water requirement cooling water temperature 15°C and air temperature < 25 °C | m ³ /h | 0.1 | 0.2 | 0.2 | 0.3 | 0.4 | 0.5 | 0.6 | 0.7 | 0.8 | 0.9 |
| Cooling water requirement cooling water temperature 25°C and air temperature < 30 °C | m ³ /h | 0.3 | 0.6 | 0.6 | 0.9 | 1.2 | 1.5 | 1.8 | 2.1 | 2.4 | 2.7 |
| Cooling water inlet pressure (before pressure reducer) | bar | 1.5–6 | 1.5–6 | 1.5–6 | 1.5–6 | 1.5–6 | 1.5–6 | 1.5–6 | 1.5–6 | 1.5–6 | 1.5–6 |
| Cooling water inlet | G..i | 3/8" | 1/2" | 1/2" | 1/2" | 1/2" | 1/2" | 1/2" | 1/2" | 1/2" | 1/2" |
| Cooling water outlet, open discharge | | 1/2 | 3/4 | 3/4 | 3/4 | 3/4 | 3/4 | 3/4 | 3/4 | 3/4 | 3/4 |

Electrical connection

| Type | | 1D | 2E | 2D | 3D | 4D | 5D | 6D | 7D | 8D | 9D |
|---|------|-------|-------|-------|-------|-------|-------|-------|-------|-------|-------|
| Mains supply, incl. booster pump | kVA | 5.5 | 7.0 | 10.0 | 14.5 | 20.0 | 22.5 | 27.5 | 34.0 | 36.0 | 38.0 |
| Infeed | 3x A | 25 | 50 | 50 | 63 | 50 | 63 | 80 | 80 | 80 | 80 |
| Enclosure rating | | IP 23 | IP 23 | IP 23 | IP 23 | IP 23 | IP 23 | IP 23 | IP 23 | IP 23 | IP 23 |

Ozone conveying device interface

| Type | | 1D | 2E | 2D | 3D | 4D | 5D | 6D | 7D | 8D | 9D |
|---|----|-------|-------|-------|------|------|------|------|-------|-------|-------|
| Connection for booster pump | A | 2.5–4 | 4–6.3 | 4–6.3 | 6–10 | 6–10 | 6–10 | 9–14 | 13–18 | 13–18 | 13–18 |
| Motor circuit breaker (standard value) | kW | 1.1 | 2.2 | 2.2 | 3.0 | 4.0 | 4.0 | 5.5 | 7.5 | 7.5 | 7.5 |

Overall dimensions

| Type | | 1D | 2E | 2D | 3D | 4D | 5D | 6D | 7D | 8D | 9D |
|---------------|----|-------|-------|-------|-------|-------|-------|-------|-------|-------|-------|
| Width | mm | 800 | 1,600 | 1,600 | 2,000 | 2,400 | 2,400 | 2,800 | 3,200 | 3,400 | 3,400 |
| Height | mm | 1,950 | 1,950 | 1,950 | 1,950 | 2,200 | 2,200 | 2,200 | 2,200 | 2,200 | 2,200 |
| Depth | mm | 500 | 500 | 500 | 500 | 600 | 600 | 600 | 600 | 600 | 600 |

Weight

| Type | | 1D | 2E | 2D | 3D | 4D | 5D | 6D | 7D | 8D | 9D |
|---------------|----|-----|-----|-----|-----|-------|-------|-------|-------|-------|-------|
| Weight | kg | 360 | 700 | 720 | 820 | 1,200 | 1,280 | 1,360 | 1,920 | 1,980 | 2,000 |

2 OZONFILT® and Bono Zon® Ozone Plants

2.7 Accessories for Ozone Plants

2.7.1 Compressors for OZONFILT® OZVa 1-4

Atlas Copco LFX compressors

The outstanding feature of this range of compressors is their outstanding value for money. They are equipped with active start unloading and automatic condensate discharge by solenoid valve. The compressors are not suitable for continuous operation and should only be used in less harsh operating conditions.

Technical Data

| Type | | LFX 0,7 | LFX 1,5 |
|---------------------------------|-------|---------|---------|
| Free air delivery rate at 7 bar | l/min | 61 | 124 |
| Power consumption at 7 bar | W | 530 | 970 |
| Number of cylinders | | 1 | 1 |
| Sound pressure level | dB(A) | 62 | 64 |
| Air receiver capacity | l | 20 | 20 |
| Weight | kg | 44 | 48 |
| Suitable for OZVa Type | | 1 + 2 | 3 + 4 |

| Type | Type | Order no. |
|---------|---------------|-----------|
| LFX 0,7 | 230 V / 50 Hz | 1004458 |
| LFX 0,7 | 230 V / 60 Hz | 1010719 |
| LFX 1,5 | 230 V / 50 Hz | 1006343 |
| LFX 1,5 | 230 V / 60 Hz | 1009638 |

Air filter kit

| | Order no. |
|--|-----------|
| Air filter kit for Atlas Copco LFX compressors | 1005789 |

Dürr ABK compressors

The outstanding feature of this continuously rated range of compressors is their extremely robust construction, making them ideally suitable for industrial use. They are equipped with active start unloading, automatic condensate discharge by solenoid valve and an hours-run meter. PTFE coated special aluminium pistons lead to the long service life and reliability of these compressor units.

Technical Data

| Type | | TA-080 | HA-234 |
|---------------------------------|-------|---------|--------|
| Free air delivery rate at 7 bar | l/min | 62 | 152 |
| Supply max. | VAC | 230 | 230 |
| Supply frequency | Hz | 50 / 60 | 50 |
| Power consumption at 7 bar | W | 800 | 1,900 |
| Number of cylinders | | 1 | 3 |
| Sound pressure level | dB(A) | 68 | 78 |
| Air receiver capacity | l | 25 | 55 |
| Weight | kg | 49 | 70 |
| Suitable for OZVa Type | | 1 + 2 | 3 + 4 |

| Type | Order no. |
|--------|-----------|
| TA-080 | 1025398 |
| HA-234 | 1025399 |

2 OZONFILT® and Bono Zon® Ozone Plants

Air filter kit

| | Order no. |
|--|-----------|
| Air filter kit for Dürr ABK compressors* | 1025400 |

* 1 filter kit is required per cylinder.

Compressors with refrigeration drying for operation in conditions of high humidity, and high-capacity screw compressors for connection to several ozone plants are available on request.

2.7.2

Oxygen Generator for OZONFILT® OZVa 5-7

OXYMAT 020

This compact oxygen generator works on the principle of pressure swing filtration of the surrounding air via a molecular sieve. When supplied with suitably dried compressed air, oxygen is generated with a purity of up to 95 % and a dew point of -70 °C. The plant develops a pressure of 4 bar at the oxygen outlet and can be directly connected to the OZVa 5-7.

Technical Data

(at 90 % oxygen yield):

| Type | | Version 1 | Version 2 |
|------------------------------------|----------------------|-----------|-----------|
| Capacity | Nm ³ /h | 0.9 | 1.2 |
| Air requirement (min. 6 bar) | Nm ³ /min | 0.17 | 0.24 |
| Power consumption incl. compressor | kW | 1.5 | 2.5 |
| Specific energy requirement | kWh/Nm ³ | 1.7 | 2.1 |

Required components for version 1

| | Order no. |
|---|-----------|
| OXYMAT 020 eco, 110-240 V / 50-60 Hz | 1044799 |
| Pressure tank O ₂ for Oxyamat O 020 eco, 90 l, 11 bar, PED with revision opening | 1044986 |
| Reciprocating compressor (oil-lubricated) Atlas Copco LE 2-10 E/100, with 100 l air receiver, 400 V / 50 Hz | 1025384 |
| Refrigeration dryer FD 5, 230 V / 50 Hz | 1025385 |
| Filter set 006, for LE 2-10 and GX 2-10 FF | 1025387 |
| Hose set with quick-release couplings, LE 2-10 to OXYMAT 020 LE 2-10 to OXYMAT 020 | 1025388 |
| Connecting set with connections for 6x4 mm PTFE hose, between OXYMAT and OZVa | 1025395 |

Required components for version 2

| | Order no. |
|--|-----------|
| OXYMAT 020 eco, 110-240 V / 50-60 Hz | 1044799 |
| Pressure tank O ₂ for Oxyamat O 020 eco, 90 l, 11 bar, PED with revision opening | 1044986 |
| Atlas Copco Aircenter GX 2-10 FF/200, with screw compressor (oil injection), integrated refrigeration drying and 200 l air receiver, 400 V / 50 Hz | 1025386 |
| Filter set 006, for LE 2-10 and GX 2-10 FF | 1025387 |
| Hose set with quick-release couplings, for connection of air treatment GX 2-10 FF with OXYMAT 020 | 1025389 |
| Connecting set with connections for 6x4 mm PTFE hose, between OXYMAT and OZVa | 1025395 |

2 OZONFILT® and Bono Zon® Ozone Plants

Accessories

| | Order no. |
|--|-----------|
| PTFE hose 6x4 mm, Admissible operating pressure 15 bar, sold in metres | 037426 |
| Service kit for Atlas Copco LE 2-10, (recommended after 8000 running hours) | 1025390 |
| Service kit for Atlas Copco GX 2-10 FF, (recommended after 8000 running hours) | 1025391 |
| Service kit 006, for Atlas Copco LE 2-10 and GX 2-10 FF | 1025392 |

2.7.3

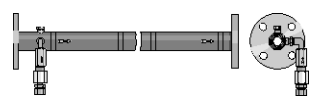

pk_7_072
Static Helical Mixer

PVC or Stainless Steel Static Helical Mixer

Designed for intensive mixing of gas with liquid flows. 4 helical blades ensure optimum mixing of the ozone with minimal pressure drop (0.1 bar per blade at maximum flow). The specified flow range of the static helical mixer should be complied with for optimum mixing results.

Version with loose flanges to DIN 2501 and integrated injection point made from stainless steel with couplings for 12 mm diam. stainless steel tube, or 12/9 mm PTFE hose, using stainless steel support inserts. In addition, the injection point is fitted with a non-return valve to protect the ozone plant from reverse flowing water. The mixers are manufactured as grease-free, so they are also suitable for Types OZVa 5-7. The stainless steel version has a G 1/4" pressure gauge tapping at the ozone mixing point.

| Flow m ³ /h | Material | Overall length mm | Connector | Order no. |
|---------------------------|----------|----------------------|-----------|-----------|
| 5 – 10 | PVC-U | 718 | DN 40 | 1024324 |
| 10 – 15 | PVC-U | 718 | DN 50 | 1024325 |
| 15 – 25 | PVC-U | 718 | DN 65 | 1024326 |
| 25 – 35 | PVC-U | 1,100 | DN 80 | 1024327 |
| 35 – 50 | PVC-U | 1,100 | DN 100 | 1024328 |
| 50 – 90 | PVC-U | 1,300 | DN 125 | 1034641 |
| 95 – 160 | PVC-U | 1,700 | DN 150 | 1034640 |
| 5 – 10 | 1.4404 | 718 | DN 40 | 1022503 |
| 10 – 15 | 1.4404 | 718 | DN 50 | 1022514 |
| 15 – 25 | 1.4404 | 718 | DN 65 | 1022515 |
| 25 – 35 | 1.4404 | 1,100 | DN 80 | 1022516 |
| 35 – 50 | 1.4404 | 1,100 | DN 100 | 1024154 |

Other sizes on request

Connecting parts for the gas pipeline

| | Order no. |
|---|-----------|
| Stainless steel pipe 12/10 mm, sold by the metre | 015743 |
| Stainless steel pipe 12/10 mm, grease-less, 1.4 m | 1022463 |
| PTFE hose 12/9 mm, grease-less, sold by the metre | 037428 |
| Stainless steel support inserts, 2 No. for 12/9 mm PTFE hose, grease-less | 1025397 |
| Stainless steel coupling 12 mm - R 1/4, grease-less | 1025755 |
| Stainless steel fitting 12 mm - R 3/8, grease-less | 1034642 |
| Stainless steel 90° elbow D 12 - D 12, grease-less | 1022462 |
| Stainless steel pressure relief valve, adjustable pressure range 0.07 – 2 bar, Connection size: 1/4" NPT, 2 additional inputs for connecting 2 pressure gauges. | 1029032 |
| Stainless steel back pressure valve for OZMa 1-3 A and OZMa 4-6 O, adjustable pressure range 0.5-10 bar, connector G 3/4" - DN 10, grease-free | 1039408 |
| Spare parts kit for back pressure valve order no. 1039408 | 1039410 |
| Stainless steel back pressure valve for OZMa 4-6 A, adjustable pressure range 0.5-10 bar, connector G 1 1/4" - DN 20, grease-free | 1039409 |
| Spare parts kit for back pressure valve order no. 1039409 | 1039411 |

2 OZONFILT® and Bono Zon® Ozone Plants

2.7.4 Accessories for OZONFILT® OZMa

The remote control module for OZMa systems enables bidirectional communication with the system control. Communication takes place optionally via a LAN, MPI or USB communications interface.

| | Order no. |
|--|------------|
| Remote control module for OZMa systems | on request |

2.7.5 Accessories for Bono Zon® Ozone Plants

Water trap

Water trap as a vacuum breaker to prevent backflow of water into the ozone generator.

Pre-assembled unit consisting of PVC loss vessel including overflow with DN 10 hose spigot, and a non-return valve with DN 20 PVC coupling.

| | Order no. |
|------------|-----------|
| Water trap | 1008781 |

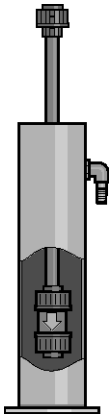

pk_7_071
Water trap

Ozone mixing

Static mixer designed for intensive mixing of gas with liquid flows. Made from PVC-U with two built-in helical mixers and a mixing section matched to the throughput.

The size depends only on the quantity of water to be ozonised.

Pressure rating: PN 4, other pressure ratings available on request.

Connection DN 65-200: loose flanges PN 10.

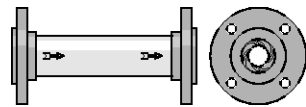

pk_7_044
Static mixer

| Recommended flow m ³ /h | Flange connection DN mm | Length mm | Order no. |
|---------------------------------------|----------------------------|--------------|-----------|
| 15-25 | 65 | 350 | 1007841 |
| 25-35 | 80 | 450 | 1007842 |
| 35-50 | 100 | 550 | 1007843 |
| 50-90 | 125 | 650 | 1007864 |
| 90-160 | 150 | 800 | 1007865 |
| 160-250 | 200 | 1,000 | 1007866 |
| 250-350 | 200 | 1,000 | 1007867 |

Higher flows on request.

Stainless steel version: on request

Ozone pumping devices

Complete ozone pumping devices consist of booster pump, injector and mixer and are assembled to suit specific project requirements. Design and technical details on request.

2 OZONFILT® and Bono Zon® Ozone Plants

Bleed valves

Bleed valves made of stainless steel 1.4571 in ozone-resistant version for mounting on reaction tanks.

| Suitable for BONA types | Connector | Pressure bar | Order no. |
|-------------------------|-----------------------------------|--------------|-----------|
| 1B | R 3/4" internal x R 1/2" external | 0 – 6.0 | 302525 |
| 1A, 1D | R 1" internal x R 1/2" external | 0 – 2.0 | 302526 |
| to 3A, 3D | R 1" internal x R 3/4" external | 0 – 2.0 | 303845 |

2.7.6

Residual Ozone Gas Destructor

Residual ozone gas destruction is used to remove traces of ozone gas from the exhaust air coming from the reaction tank. Because the exhaust air from the reaction tank still contains water, the pipework should be suitably routed so as to ensure that the water is drained off at the inlet side.

A suitable drainage connection should be provided here too as the exhaust air after the residual ozone gas destructor is still up to 100 % saturated with water vapour, and because small temperature fluctuations, even on the outlet side, can lead to flowback of condensate.

The exhaust air from any downstream filter plant that may be fitted can also be routed via this ozone gas destruction unit.

PVC version

Residual ozone destructor based on active carbon granules in a PVC housing.

| | Type | Ozone quantity g/h | Order no. |
|---------------------------------------|------|--------------------|-----------|
| Residual ozone destructor 3 L | 10 | 10 | 879022 |
| Residual ozone destructor 14 L | 40 | 40 | 1004267 |
| Residual ozone destructor 30 L | 100 | 100 | 879019 |
| Residual ozone destructor 60 L | 200 | 200 | 879018 |

Note:

The stated ozone quantities refer to quantities added to the raw water. The residual ozone destructor is designed for the normal residual ozone concentration found in swimming pool applications. It may only be used in plants with air as operating gas and a maximum added quantity of 1.5 g of ozone/m³ treated water.

Stainless steel version

Residual ozone destructor based on a maintenance-free MnO catalytic converter with integrated heating, 230 V, 50-60 Hz. Connections Rp 1/2" or flanges to DIN 2642, PN10. Types 18 to 110 m³/h also fitted with Rp 1/2" ball valve as condensate drain.

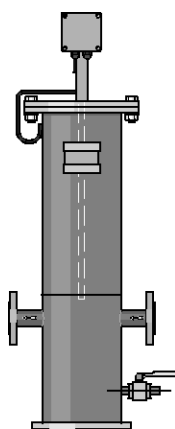

pk_7_073
Residual ozone destructor

| Max. gas flow m ³ /h | Heating power W | Dimensions H x W x D mm | Connector | Order no. |
|---------------------------------|-----------------|-------------------------|-----------|-----------|
| 1.5 | 100 | 700 x 110 x 180 | Rp 1/2" | 1018440 |
| 8.0 | 100 | 735 x 110 x 235 | Rp 1/2" | 1018406 |
| 18.0 | 140 | 1,154 x 275 x 240 | DN 25 | 1019155 |
| 28.0 | 140 | 1,154 x 300 x 259 | DN 25 | 1021037 |
| 40.0 | 500 | 1,156 x 330 x 264 | DN 25 | 1026335 |
| 73.0 | 500 | 1,158 x 400 x 320 | DN 32 | 1019971 |
| 110.0 | 500 | 1,160 x 450 x 375 | DN 40 | 1027238 |

Note:

The catalytic residual ozone destructor must only be used in chlorine-free gas flows. The PVC version must therefore be used for swimming pool applications.

2 OZONFILT® and Bono Zon® Ozone Plants

2.7.7

Room Air Monitor

Gas warning device GMA 36 – ozone and oxygen

Calibratable gas warning devices with digital display of the detected gas concentration. 2 relay outputs for issue of infringements of warning and alarm thresholds, to switch external alarm sounder and for interlocking with the ozone plant. The warning message relay is self resetting, the alarm relay is a latching type and should be acknowledged at the device. 1 self-resetting relay for connection to an alarm horn is switched in the event of fault conditions and when the alarm limit is exceeded.

The ozone sensor responds to all strongly oxidising gases, hence it responds to chlorine gas or chlorine dioxide too.

The GMA 36 oxygen warning device is intended for installations where an unacceptably high oxygen enrichment of the ambient air is possible.

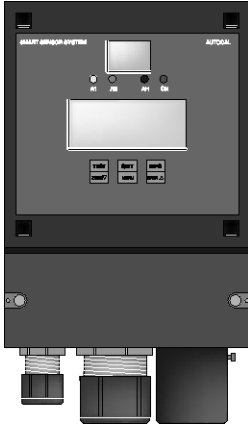

pk_7_004_1
Gas warning devices GMA 36

Technical Data

| Type | Ozone | Oxygen |
|---|-----------------------|------------------|
| Warning at approx. | ppm/vol% 0.3 | 23.0 |
| Alarm at approx. | ppm/vol% 0.5 | 25.0 |
| Permissible ambient temperature | °C -15...45 | -15...45 |
| Protection class housing | IP 54 | IP 54 |
| Dimensions (without PGs, without sensor) H x W x D | mm 247 x 135 x 95 | 247 x 135 x 95 |
| Supply | V/Hz 85 – 264/50 – 60 | 85 – 264/50 – 60 |
| Power consumption | W 5 | 5 |
| Warm-up phase max. | s 150 | 20 |
| "Warning" relay contact, self-resetting | V/A 230/1 | 230/1 |
| "Alarm" relay contact, latching | V/A 230/1 | 230/1 |
| "Horn" relay contact, latching, can be acknowledged | V/A 230/1 | 230/1 |
| Sensor measuring principle | electrochemical | electrochemical |
| Sensor service life (depending on environmental cond.) | Years 2–3 | 2–3 |
| | Type | Order no. |
| Gas warning device GMA 36 | Ozone | 1023155 |
| Gas warning device GMA 36 | Oxygen | 1023971 |

Spare parts

| | Order no. |
|---|-----------|
| Replacement sensor for chlorine, chlorine dioxide, ozone | 1023314 |
| Replacement sensor for oxygen | 1023851 |
| Replacement sensor for gas warning devices in the Life CGM range | 1003009 |

Mounting kit

| | Order no. |
|--|-----------|
| Mounting kit for direct mounting of the CGM 1060 and GMA 36 ozone warning devices on the housing of the OZVa plants | 1004248 |
| Support bracket for mounting kit for all types of OZVa except OZVa 1/2 with transparent mixing system | 1005854 |

2 OZONFILT® and Bono Zon® Ozone Plants

Warning light and horn

Combined horn and red warning lamp. IP 33 enclosure made of impact-resistant ABS. Dome made of clear polycarbonate. Connected load: 230 V AC, 50 mA. Supplied complete with B 15 d / 7 watt bulb.

| | Order no. |
|-------------------------------|-----------|
| Warning light and horn | 1010508 |

Gas tracing pump

Hand operated, non-continuously working test tube pump for fast and accurate measurement of ozone gas. Complete with 10 no. ozone gas test tubes 0.05-5 ppm in carrying case.

| | Order no. |
|-------------------------|-----------|
| Gas tracing pump | 1025533 |

Potassium iodide starch paper

Roll with 4.8 m test strip for leak detection on pipelines carrying ozone gas.

| | Order no. |
|--------------------------------------|-----------|
| Potassium iodide starch paper | 1025575 |

2.7.8

Cooling water heat exchanger

A heat exchanger can be used as an alternative to the use of fresh water as cooling water. The cooling water is fed through the heat exchanger and ozone system in a circuit. The cooling water heat exchanger discharges the heat to the surroundings.

Technical Data

- Single circuit system with tank open to the atmosphere
- Air-cooled refrigeration unit
- Integral evaporator
- Plastic tank with water level display and level switch with alarm contact
- Microprocessor-controlled temperature controller with digital display
- Integral pump
- Manometer
- Powder-coated exterior housing

| Part no. | | 1043847 | 1043848 | 1043849 | 1043850 |
|--------------------------------------|----------|---------------------------|-------------|---------------------------|-------------|
| Refrigerant | CFC-free | R404a | R404a | R134a | R134a |
| Useful cooling power at 20 °C | kW | 2.5 | 3.6 | 4.9 | 6.0 |
| Working range | °C | +10 / +25 | +10 / +25 | +5 / +25 | +5 / +25 |
| Pump | Type | P16-YA62D | P16-YA62D | P3-BR11B | P3-BR11B |
| Pump output | l/min | 5.0 | 5.0 | 16.7 | 18.3 |
| Pump pressure | bar | 3.0 | 3.0 | 2.2 | 2.1 |
| Contents | l | 13 | 13 | 30 | 30 |
| Water connectors | Inch | < 1/2 " internal thread > | | < 3/4 " internal thread > | |
| Power consumption 230 V/400 V | kW | 1.6 / - | 2.2 / - | - / 2.2 | - / 1.8 |
| Mains connection | V/Hz/Ph | 230/50-60/1 | 230/50-60/1 | 400/50/3 | 400/50/3 |
| Weight | kg | 35 | 47 | 123 | 125 |
| Outside dimensions (WxDxH) | mm | 480x745x445 | 480x745x445 | 580x650x920 | 580x650x920 |

| | Suitable for type | Order no. |
|-------------------------------------|----------------------------------|-----------|
| Cooling water heat exchanger | OZVa 1-7, OZMa 1-2 A, OZMa 1-2 O | 1043847 |
| | OZMa 3 A, OZMa 3 O, OZMa 4 O | 1043848 |
| | OZMa 4 A, OZMa 5 A, OZMa 5 O | 1043849 |
| | OZMa 6 A, OZMa 6 O | 1043850 |

2 OZONFILT® and Bono Zon® Ozone Plants

2.7.9 Personal Protection Needs

Gas mask

Ozone-resistant, full-face respiratory protective mask with panoramic window shield to EN 136 Class 3. Medium size with EN 148-1 threaded pipe connection. Complete with combination filter NO-P3 and carrying case.

| | Order no. |
|----------|-----------|
| Gas mask | 1025574 |

Warning label

Warning label in accordance with the "Guidelines for the use of ozone for water treatment" ZH 1/474, issued by the central office of the industrial safety associations. Version supplied as a combined adhesive label with markings as follows: warning sign, ozone plant room indication and prohibited activity signs.

| | Order no. |
|---------------|-----------|
| Warning label | 740921 |

Emergency stop switch

For installation near the door of the ozone plant room. IP 65 PVC enclosure.

| | Order no. |
|-----------------------|-----------|
| Emergency stop switch | 700560 |

2.7.10 Overvoltage Protection

Overvoltage protection for OZONFILT® systems operated at 230 V 50-60 Hz.

The external overvoltage protection is intended for the operating case where the device internal protection is insufficient for surge voltages of 1 kV between the conductors and of 2 kV to earth. To protect the system when the supply mains is prone to power transients an overvoltage trip can be fitted as a low protection surge arrester to significantly increase the stability of the ozone systems.

Whether the low protection surge arrester requires further measures such as medium and main protection can only be determined by thorough investigation of the voltage behaviour on site.

| | Order no. |
|------------------------------------|-----------|
| Fine protection PT 2-DE IS 230 IAC | 733010 |

2.7.11 Replacement Plug-in Insert after Tripping

| | Order no. |
|--|-----------|
| Replacement plug-in insert PT 2-DE / S 230 / AC - ST | 733011 |