



# PUMPS

PUMPS | VALVES | INSTRUMENTATION



PRODUCT OVERVIEW

# SETTING STANDARDS OF PERFECTION AND RELIABILITY

ASV Stübbe is an international manufacturer of pumps, valves, instrumentation and control systems made of thermoplastics.

▶ **Products for demanding tasks in many fields of industry**



As a system supplier we offer a wide range of high-quality solutions for the handling of aggressive, corrosive and water polluting substances.

With over 50 years of fieldexperience we have a solid foundation of expert know-how for the design of pumps and piping systems where resistance to chemicals must be taken into account.

The benchmark of our success is customers' satisfaction. Our main aim is to provide economic solutions combined with a maximum of safety and reliability.



### Environmental technology

- Sea water desalination
- Wastewater treatment
- Exhaust air scrubbers
- Biogas treatment
- Ultra-pure water
- Process water
- Manufacturing of bio fuels
- ...

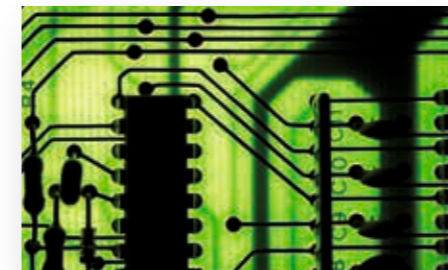

### Surface technology

- PCB manufacture
- Solar cell manufacturing
- Electroplating
- Glass finishing
- Coating lines
- ...



### Chemical industry

- Chemical plant manufacturing
- Acid production
- Fertilizer production
- Chlor-alkali electrolysis
- ...



### Metallurgy

- Ore extraction
- Copper electrolysis
- Acid regeneration
- Nickel electrolysis
- Steel pickling
- ...

## PRODUCT RANGE

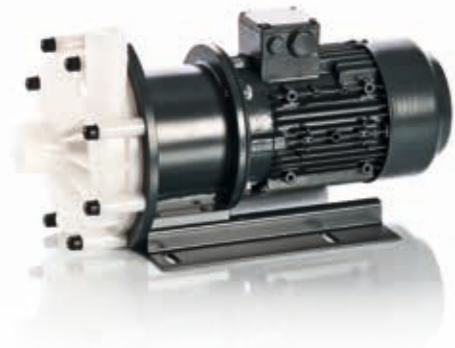

### Pumps

ASV Stübbe produces pumps for the safe transport of aggressive and corrosive liquids of up to 1,100 m<sup>3</sup>/h. Our range includes horizontal as well as vertical pumps from highly corrosion and wear resistant materials.



### Valves

Our wide range of valves offers solutions for almost any application. Next to our extensive standard range also customised solutions can be realised for your specific process requirements.



### Instrumentation





Our systems for filling level, pressure and flow control are of robust design and suitable for fast and efficient systems integration. We manufacture corrosion resistant instrumentation technology for tank and plant builders.

## CONTENTS

<b>Centrifugal pumps</b>	<b>6</b>
Centrifugal pump NM	8
Centrifugal pump NMB	9
Centrifugal pump SHB	10
Magnetically driven centrifugal pump SHM	12
<b>Sump pumps</b>	<b>14</b>
Sump pump ET	16
Sump pump ETL	18
Sump pump ETLB	20
<b>Displacement pumps</b>	<b>22</b>
Eccentric pumps L/F	22
<b>Pump guards</b>	<b>24</b>
<b>Motor and design</b>	<b>26</b>



# CENTRIFUGAL PUMPS

Typ ASV	NM	NMB	SHB	SHM
Pressure connection	DN 32 – DN 150	DN 32 – DN 80	DN 15 – DN 100	DN 20 – DN 50
Material				
H <sub>max</sub> [m]	98	59	40	27
Q <sub>max</sub> [m <sup>3</sup> /h]	530	100	85	65
Motor [kW]	110	7,5	11	7,5

The pump is a key component for ensuring that processes function reliably. As a result of decades of experience, ASV Stübbe is also able to supply solutions for extreme operating conditions. Operational safety and reliability are our top priorities.

In times of rising energy costs, efficiency is a further important key factor, so ASV Stübbe not only focuses on the pump drive, but on the overall package. ASV offers its customers state-of-the-art electrical drives and hydraulics optimised by means of flow simulation software.

Depending on the required operating point and medium, the pumps are configured with an optimum combination of different drive concepts and adapted hydraulics.

In addition to providing the optimum technical solution, ASV Stübbe offers a modern modular system and a high degree of vertical integration with short delivery times and optimum availability throughout the entire spectrum of pumps, valves and instrumentation.

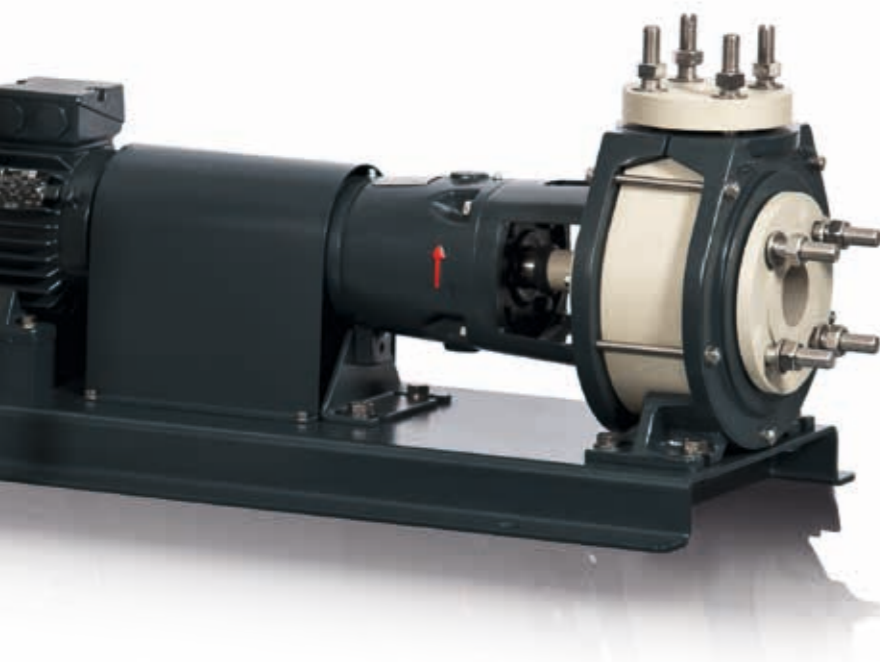

## Horizontal pumps

Horizontal, mechanically sealed centrifugal pumps are widely used for the safe transport and circulation of aggressive, corrosive acids and lyes and many other hazardous liquids.

## Mechanical seals

Mechanical seals are responsible for the seal between the rotating pump shaft and the pump housing. The dynamic seal consists of a spring loaded sliding ring and a counter ring. Mechanical seals for chemical applications are made from very special materials and have to be carefully selected with regard to the used fluid.



## CENTRIFUGAL PUMP NM



### Material

- - PP
- - PE
- - PVDF



### Mechanical seal

- - single acting inside
- - single acting outside
- - double acting chamber
- - double acting quench



### Motor

- - 0,55 kW
- ...
- - 110 kW

### Centrifugal pump NM

Standard chemical pumps from Series NM meet the installation dimension specifications according to DN 24256 and ISO 2558. The robust hydraulic parts are made of highgrade thermoplastic reinforced by an additional metal frames. Pumps from the NM series are available as hydraulic with coupling or as complete units including standard motor and base plate. Because of the wide performance spectrum of the NM range these pumps can be found in virtually all areas where aggressive or corrosive liquids are being handled.

$H_{max}$  98 m  
 $Q_{max}$  530 m<sup>3</sup>/h



## CENTRIFUGAL PUMP NMB



### Material

- - PP
- - PE
- - PVDF



### Mechanical seal

- - single acting inside
- - single acting outside
- - double acting chamber
- - double acting quench



### Motor

- - 1,1 kW
- ...
- - 7,5 kW

### Centrifugal pump NMB

The compact NMB block pumps are based on the hydraulics from the NM series. In this version, however, the motor is directly flanged to the housing and has no further bearing or coupling elements. The economic design principle covers the performance range from 1.1 - 7.5 kW. Just like the NM series the hydraulic part can be equipped with a variety of mechanical seals, quench systems or buffer fluid connections.

$H_{max}$  59 m  
 $Q_{max}$  110 m<sup>3</sup>/h

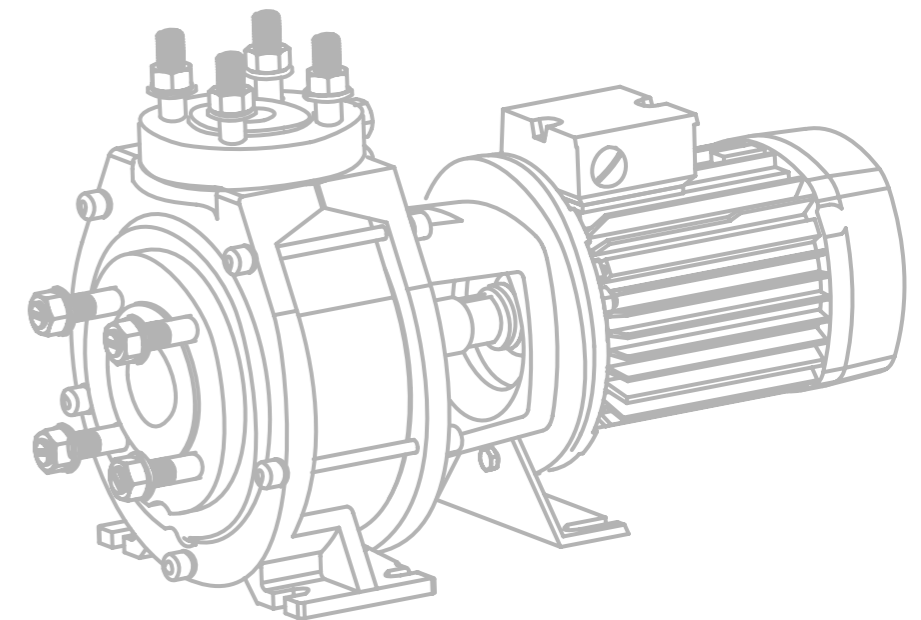

# CENTRIFUGAL PUMP SHB

## Centrifugal pump SHB

The SHB is a mechanically sealed horizontal centrifugal pump. The standard motor is connected to the pump shaft by a coupling. SHB centrifugal pumps can be supplied with the same scope of mechanical seals, quench systems and buffer fluid connections like the ASV standard chemical and block pumps.

SHB centrifugal pumps are an economic alternative to standard chemical pumps whenever aggressive and corrosive fluids need to be transported but no chemical standard installation connections are required.

$H_{\max}$  40 m  
 $Q_{\max}$  125 m<sup>3</sup>/h

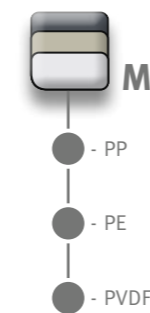

**Mechanical seal**

- single acting inside
- double acting



**Motor**

- 0,37 kW
- ...
- 11 kW



# MAGNETIC COUPLED CENTRIFUGAL PUMP SHM

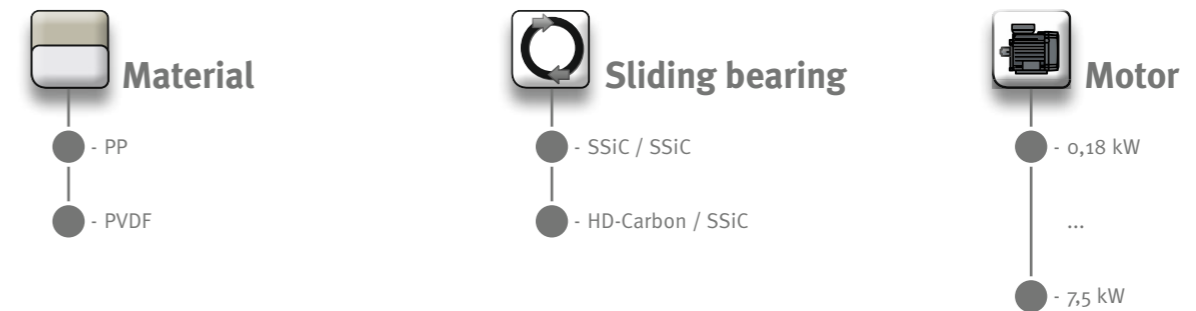

## Magnetic coupled centrifugal pump SHM

In contrast to sliding bearing sealed pumps SHM magnetic coupled pumps have an hermetically sealed hydraulic system and are dry run capable. Because of this they can easily be integrated into almost any aggressive or corrosive application. They require less chemical resistance considerations compared to mechanically sealed systems and are capable to withstand interruptions of the fluid flow without problems. ASV Stübbe magnetic coupled pumps contain especially powerful magnet systems which are designed for use with up to 7,5 KW motors. The low vibration hydraulic is available in a full PVDF version and is therefore suitable for high purity applications in surface technology or glass etching processes in the photovoltaic industry.

$H_{max}$  27 m  
 $Q_{max}$  65 m<sup>3</sup>/h

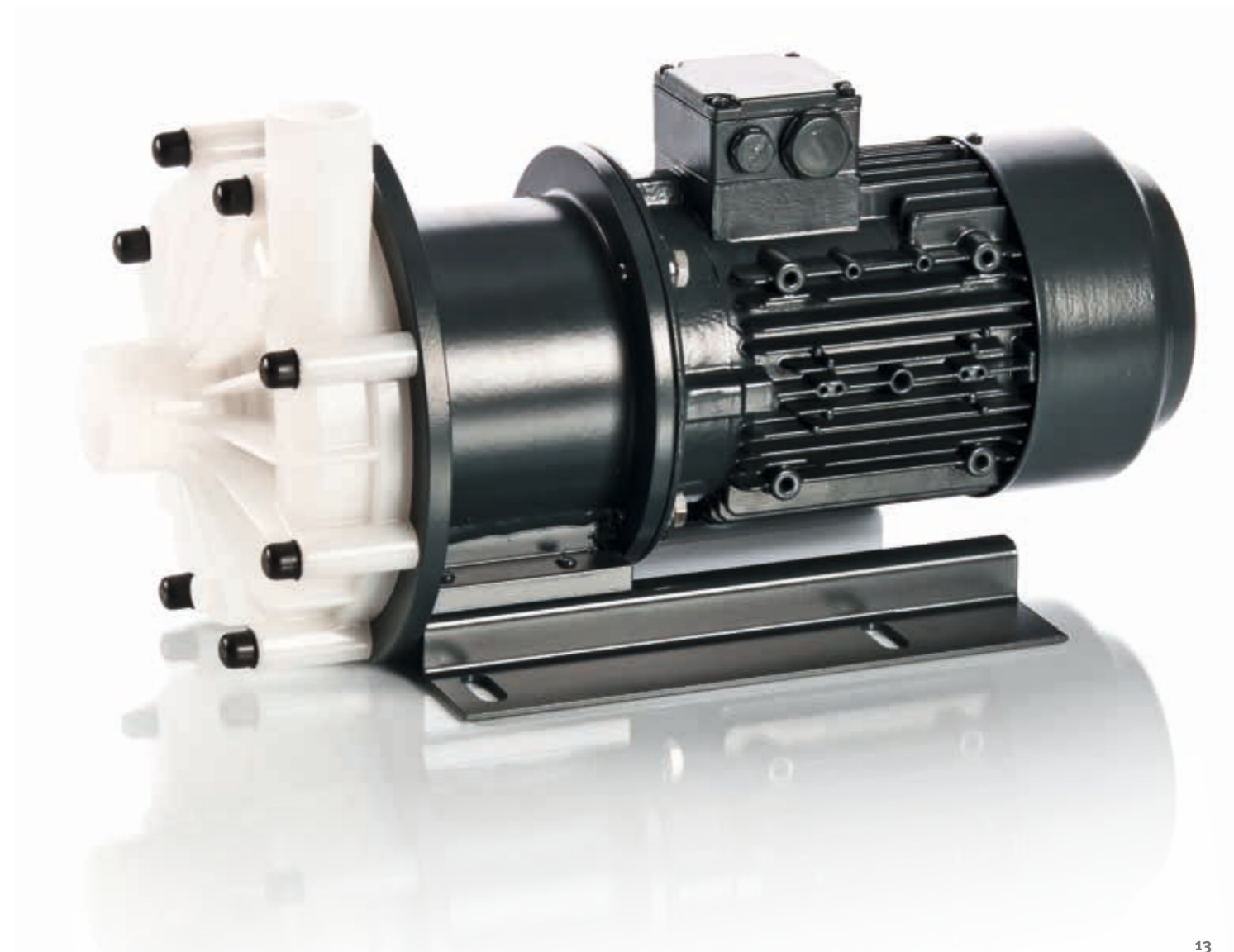

## SUMP PUMPS

Typ ASV	ET	ETL	ETLB
Pressure connection	DN 15 – DN 80	DN 20 – DN 80	DN 15 – DN 80
Material	<div style="display: flex; gap: 5px;"> <div style="border: 1px solid black; padding: 2px;">PP</div> <div style="border: 1px solid black; padding: 2px;">PVDF</div> </div>	<div style="display: flex; gap: 5px;"> <div style="border: 1px solid black; padding: 2px;">PP</div> <div style="border: 1px solid black; padding: 2px;">PVDF</div> </div>	<div style="display: flex; gap: 5px;"> <div style="border: 1px solid black; padding: 2px;">PP</div> <div style="border: 1px solid black; padding: 2px;">PVDF</div> </div>
H <sub>max</sub> [m]	56	65	42
Q <sub>max</sub> [m <sup>3</sup> /h]	120	220	100
Motor [kW]	22	45	7,5

Sump pumps are intended for use in open or not pressurised containers or in pump sumps. Because of their special way of installation the unlike horizontal pumps do not require mechanical shaft seals. In the presence of aggressive gases in the tanks an external seal is being achieved by the use of labyrinth seal systems. Such are available in various materials up to titanium options.

Every pump is being tested acc. to DIN 1944 and can be supplied with a certificate acc. to DIN 50049.

**Customised solutions and accessories**  
 Sump pumps often have to match specific installation situations. Mounting plates, fixing holes and pressure port connections therefore can be customised according to individual requirements.

Suction tube extensions up to 2000 mm allow the complete evacuation of tanks. Suction strainers safeguard the troublefree operation even in case of bigger objects in the fluids. In case of a lack of space inside the container the ETLB series can also be dry mounted. In this case the pump is mounted on the outside of the tank.

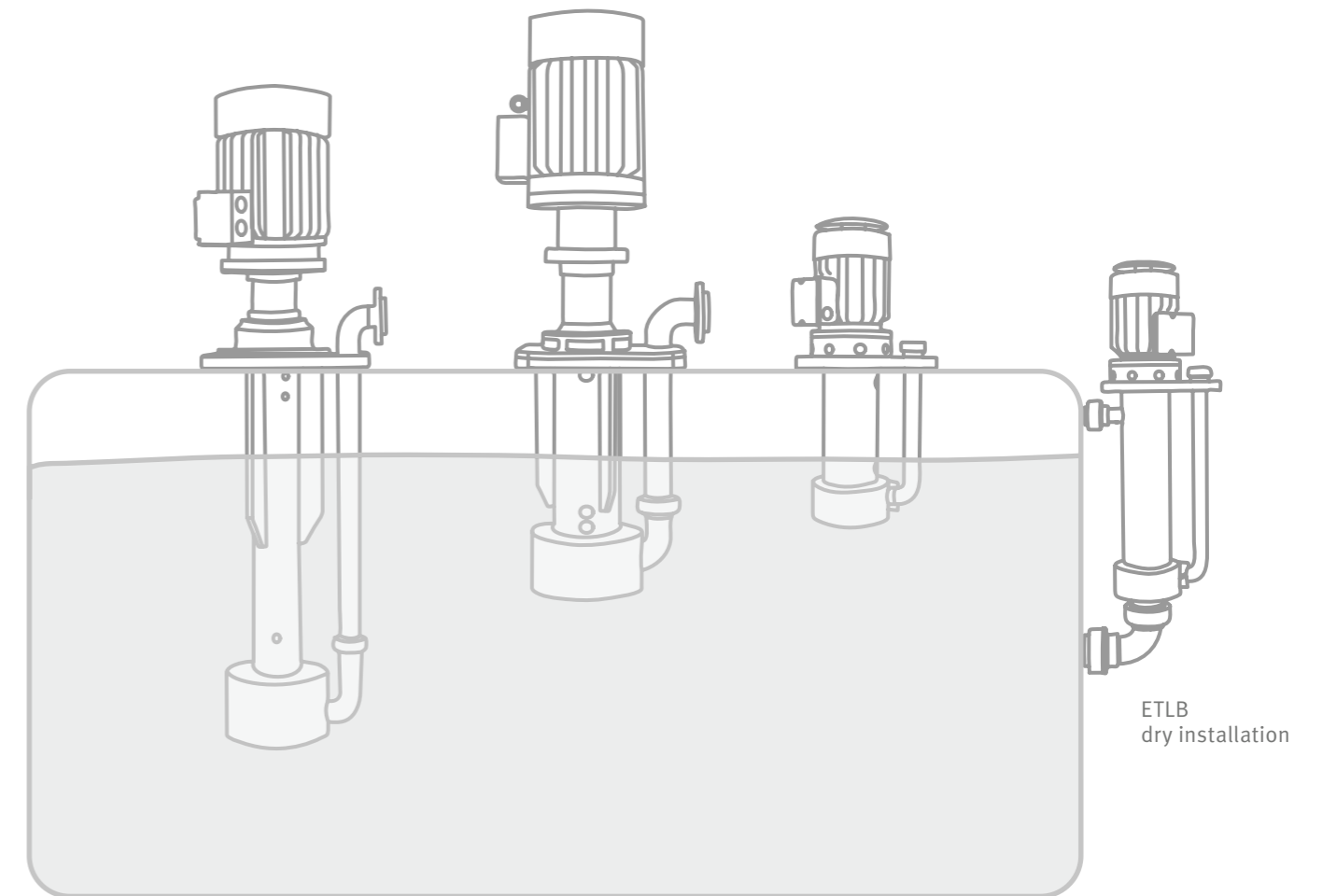

### ET

- Fluid-wetted shaft bearing
- Submersion depth up to 2.000 mm
- Dry-run capable bearing combinations available

### ETL

- Powerful external bearing outside the tank
- For Motors up to 45 kW
- Submersion depth up to 750 mm
- Dry-run safe

### ETLB

- Design with long motor shafts without bearings
- Submersion depth up to 475 mm (495 mm)
- Dry-run safe



# SUMP PUMP ET

## Plastic sump pumps ET

The ET sump pumps with wetted bearing design are built to a fully modular system. This series is a jack-of-all-trades used in all areas of the chemical industry because of its high flexibility. It can be supplied in a wide range of designs and in many material combinations, with all types of mounting plates and connection ports and with standard motors of up to 22 kW. Because of the wetted shaft bearing submersion depths of 2.000 mm can be supplied.

$H_{max}$  56 m  
 $Q_{max}$  120 m<sup>3</sup>/h

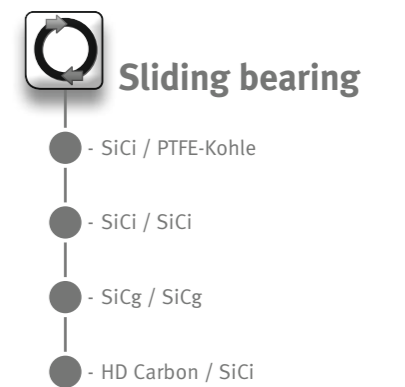
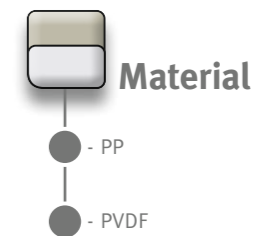
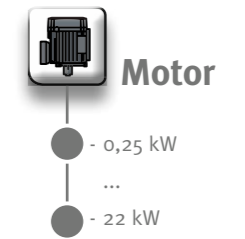
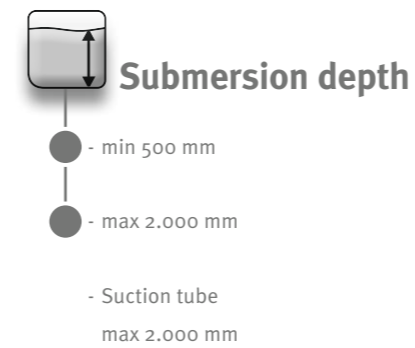

# SUMP PUMP ETL

## Plastic sump pump ETL

The robust shaft bearing of the ETL type series pumps is installed on top of the mounting plate. The bearing position outside the fluid makes the pump dry run safe. The strong design allows the mounting of up to 45 kW motors and is available for submersion depths of up to 750 mm. Because of their wide performance spectrum and the high possible flow rates these pumps are often used in heavy duty industrial applications in metal extraction processes or chemical applications.

$H_{max}$  65 m  
 $Q_{max}$  240 m<sup>3</sup>/h



**Stübbe**<sup>®</sup>  
Partner for Solutions



**Motor**

- 0,18 kW
- ...
- 45 kW



**Submersion  
depth**

- min 500 mm
- max 750 mm

- Suction tube  
max 1.800 mm



**Material**

- PP
- PVDF

# SUMP PUMP ETLB

## Plastic block pump ETLB

The ETLB series is designed as a block sump pump. Motor and shaft are one integral unit and because of this the pump does not require any additional bearings. The therefore also dry-run safe design makes it an extremely robust solution and allows submersion depths of up to 750 mm. Because of the straight forward structure it is also very economic and being used in applications from gas scrubbers in the environmental industry to surface treatment plants in the solar cell production.

$H_{\max}$  42 m  
 $Q_{\max}$  100 m<sup>3</sup>/h



 **Motor**

- 0,18 kW
- ...
- 7,5 kW

 **Submersion depth**

- min 275 mm
- max 475 mm (495 mm)

- Suction tube  
max 1.500 mm



 **Material**

- PP
- PVDF



## DISPLACEMENT PUMPS

## ECCENTRIC PUMP L/F

Typ ASV	Typ F	Typ L
Pressure connection	DN 14 – DN 19	DN 14 – DN 38
Material		
$H_{max}$ [m]	25	40
$Q_{max}$ [m <sup>3</sup> /h]	1,8	4,8
Motor [kW]	0,37	1,1

Eccentric pumps are displacement pumps. The fluid is pumped by an eccentric moving the fluid between a thick rubber liner and the pump housing. Eccentric pumps are dry run capable, free of cavitation and self-priming. Based on their special design with high-grade rubber liners and robust plastic housings they are multi-purpose pumps even for difficult, aggressive fluids with high viscosities or particle contents.



Typ F

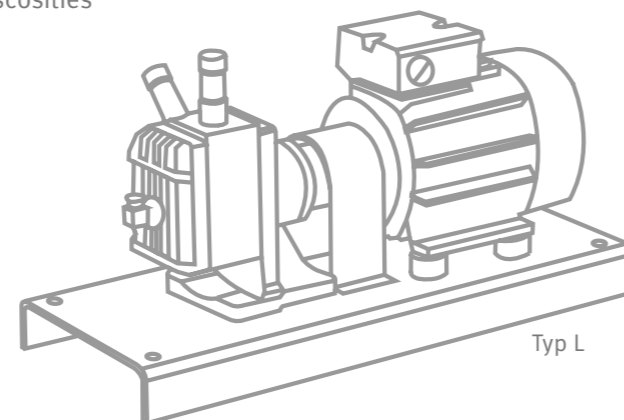

Typ L

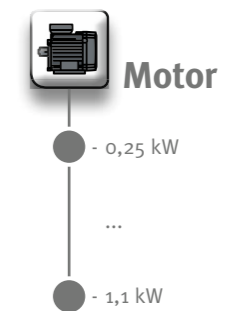
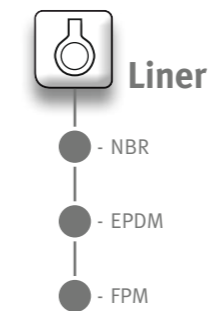
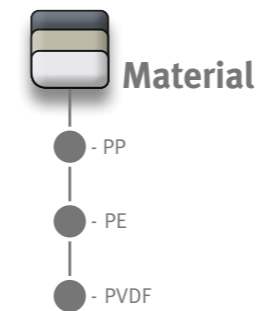

### Eccentric pumps

ASV eccentric pumps are dry-run capable, self-priming displacement pumps. They are specifically suitable for frequency regulation or mobile applications. By design they require only little maintenance and are available in two different versions. Type F pumps are flanged directly to the motor, whereas type L pumps have a coupling and come on a base plate. Both types come with hose nozzels for a flexible connection to the pipeline systems.



# PUMP GUARD



## Dry-run protection

One of the most frequent failure causes for the operators of thermoplastic centrifugal pumps is running dry. Like metal pumps of the same type, thermoplastic centrifugal pumps are reliant on the fluid at mechanical seals and sliding bearings for lubrication and cooling.

The absence of fluid lubrication due to system malfunctions can cause a rise in temperature over 100°C at sliding bearing parts within a very short time. Even brief overheating can lead to melting of the structural thermoplastic casing parts, within worstcase causing total destruction of the pump.

Due to its many years of experience with thermoplastic pumps, ASV Stübbe decided to use a combined intelligent monitoring of pressure and temperature for this application.



## Pressure and temperature sensor PTM

The sensors of the PTM series register pressures of 0 – 10 bar and temperatures between -10°C and +100°C. The highly resistant ceramic sensors made of Al<sub>2</sub>O<sub>3</sub> can be easily integrated in any pipe due to their standard union connection. The sensors can be optionally protected by a non-permeable PFA film from particularly aggressive media.

If the registered pressure or temperature falls outside the permitted range, the PTM switches off the pump before damage can occur. The compact device is equipped with its own processor which can be individually programmed. This allows the pump to be monitored completely independently, i.e. without additional control systems. The PTM offers the additional flexibility of being suitable for use in a wide variety of control system concepts thanks to its different configurable signal output modules.

The device profile is complemented by the removable UNI Display, and the user-friendly menu navigation. Each UNI Display is equipped with a slot for SD cards which can be used to save process data or to load software updates and settings for different applications. The device can be used as pump guard and data logger for various processes.



## Pressure and temperature sensor PTM Flex

The PTM is also available with a separate sensor module especially for difficult-to-reach or highly contaminated locations.



# MOTOR AND DESIGN



An intelligent usage of electrical drives offers an enormous potential for energy savings. According to latest international surveys about 10% of the available electricity worldwide is being consumed by pumps.

To realize this potential for energy efficiency the European Commission has as part of the EUP guide line passed the following legislation towards energy efficient AC standard motors and electrical drives:

- Since June 2011 inside the EU only AC standard motors with a size of 0.75 to 375 kW meeting the IE2 regulations may be put into circulation.
- Since 2015 all standard motors bigger than 7.5 kW have to meet the specifications of the IE3 standard or must be further to the IE2 standard requirements be equipped with rev regulators.
- As of 2017 the IE3 regulation also applies to 0.75 to 7,5 kW electric motors.

All listed pumps are fitted with motors according to IE 2 standard.

### Optimum efficiency

Reduced energy cost and overall cost evaluations – perfect results can only be achieved by a precise matching of the operational features of the pump and the pipework.

Further to the utilization for energy efficient motors ASV Stübbe puts a focus on the optimization of the mechanical part of the pump in order to achieve best possible efficiency ratings.

IT based optimization tools allow the modification of the impellers to reach the best operational features of the pump. Further to that all pumps are put to a 100% test to verify the practical performance of the design features. And of course all ASV-motors can be equipped with rev regulators.

Integrated modular systems and a high vertical integration allow short lead times and the best possible availability.

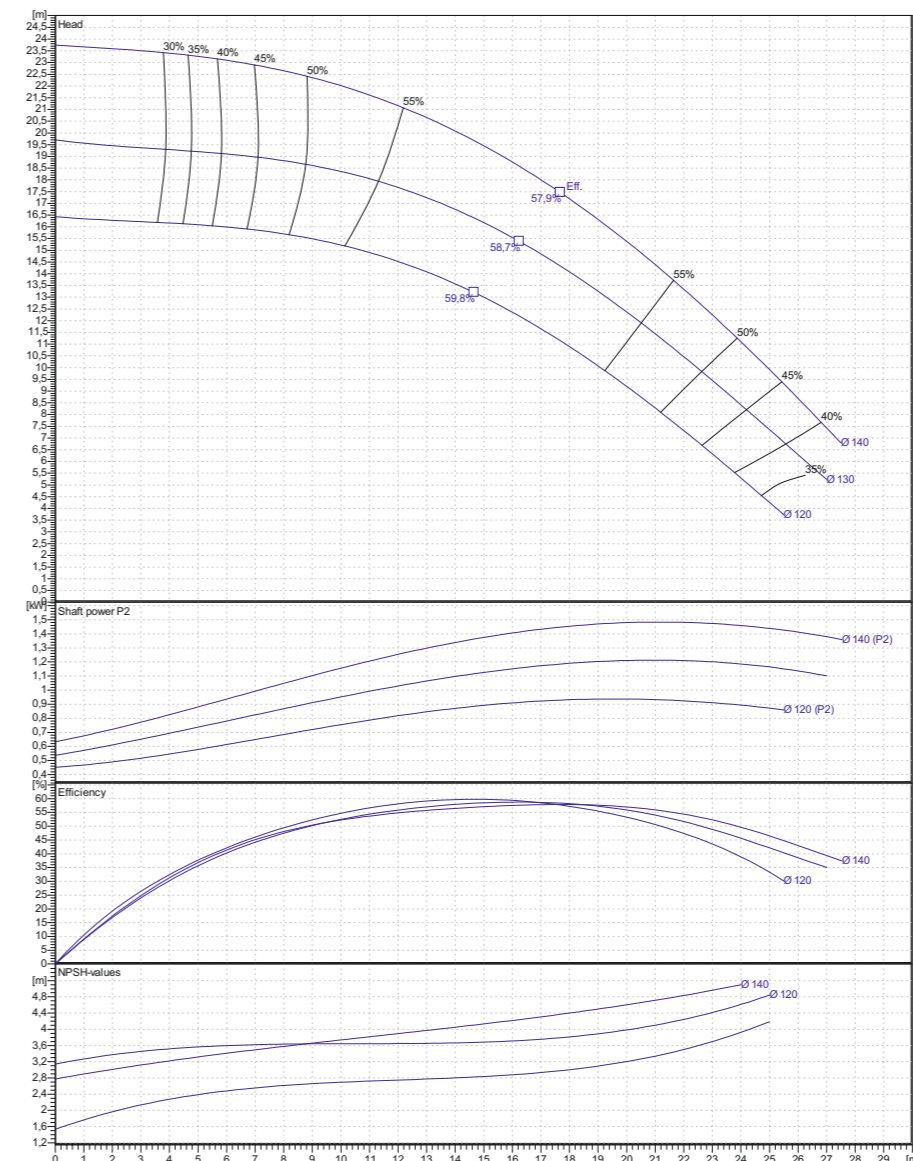

Hydraulic pump design with operational performance, NPSH-value, efficiency and shaft power rating

## SUBSIDIARIES

### EUROPE:

#### Headquarter:

 **ASV Stübbe GmbH & Co. KG**  
 Hollwieser Str. 5  
 D-32602 Vlotho, Germany  
 Phone +49 5733 799-0  
 Fax +49 5733 799-5000  
[contact@asv-stuebbe.de](mailto:contact@asv-stuebbe.de)  
[www.asv-stuebbe.de](http://www.asv-stuebbe.de)

 **ASV Stübbe España S.L.U.**  
 C/Constitució N<sup>o</sup> 4 Local 14  
 08960 Sant Just Desvern/Barcelona  
 Spain  
 Phone +34 93 47746-10  
 Fax +34 93 47746-11  
[contact@asv-stuebbe.es](mailto:contact@asv-stuebbe.es)

 **ASV Stübbe France SARL**  
 Immeuble « Le Cérès »  
 21-23 rue du Petit Albi  
 BP 48453  
 95807 Cergy Pontoise Cedex  
 France  
 Phone +33 1 307510-45  
 Fax +33 1 307510-46  
[contact@asv-stuebbe.fr](mailto:contact@asv-stuebbe.fr)

### CHINA:

 **ASV Stuebbe Pumps & Valves**  
 **(Suzhou) Co., LTD**  
 No. 16 Nanguandu Road, Yuexi  
 Wuzhong District  
 Suzhou, Jiangsu, China 215104  
 Phone +86 512 66566-846  
 Fax +86 512 66566-932  
[contact@asv-suzhou.com](mailto:contact@asv-suzhou.com)

#### Partners and representatives worldwide

For a current overview of all countries please visit our website:  
[www.asv-stuebbe.com](http://www.asv-stuebbe.com)



# QUALITY MANAGEMENT AND SERVICE

▶ Reliability and chemical resistance



Service to us means 360° support for our customers. From the selection of the proper materials through to after sales service - use our expertise and experience to minimise your cost and effort and maximise your market impact.

In-process inspections and quality control of components guarantee high quality final products.

Quality, perfection and safety are the guiding principles of our company. After all, our products have to reliably resist the most aggressive and water-polluting medium types.

Materials and products are permanently inspected in demanding quality tests in our own company laboratory.



Quality management system certified according to DIN EN ISO 9001:2008







**ASV Stübbe GmbH & Co. KG**  
Hollwieser Str. 5  
D-32602 Vlotho, Germany  
Phone +49 5733 799-0  
Fax +49 5733 799-5000  
contact@asv-stuebbe.de  
[www.asv-stuebbe.com](http://www.asv-stuebbe.com)

**ПромХимТех - официальный дистрибьютор  
Stubbe**  
[www.promhimtech.ru](http://www.promhimtech.ru)  
[zakaz@promhimtech.ru](mailto:zakaz@promhimtech.ru)  
8 800 250 0154