

– официальный представитель и сервисный партнер

www.promhimtech.ru
zakaz@promhimtech.ru
тел. 8 800 250 01 54

ProMinent[®]

Water treatment and water disinfection



2018



Issued by:

ProMinent GmbH
Im Schuhmachergewann 5-11
69123 Heidelberg
Germany
Phone +49 6221 842-0
info@prominent.com
www.prominent.com



Technical changes reserved.

All previous catalogues and price lists are superseded with the release of this product catalogue.
You can view our general terms and conditions on our homepage.

Heidelberg, January 2018

Water Treatment and Water Disinfection



A clear case of disinfection

Hygienically pure water is one of the greatest challenges of our time. With ProMinent® products and systems - combined with our many years of practical experience - we have developed application-based solutions for a range of different industries. They are characterised by their outstanding handling of natural resources, minimal operating costs and maximum efficiency.

Chapter 1 offers **UV systems** for the gentle and chemical-free disinfection of water. They are ideal for applications associated with the treatment of potable water or swimming pool water, as well as in the beverage industry.

Refer to **Chapter 2** for the effective removal of undesirable organic and inorganic substances or for efficient disinfection in the treatment of cooling and process water. The chapter focuses on **ozone systems** with the most diverse capacity ranges. Choose from this diverse product range for a trouble-free outcome - advice included!

Avoid undesired by-products that occur with standard disinfection with chlorine. To this end, refer to **chapter 3** for economically and ecologically sensitive alternative disinfection methods with **chlorine dioxide**.

Chapter 4 describes **electrolysis systems**, precisely the right alternative for ultra-environmentally-friendly applications, for example instead of chlorine gas.

Metering systems for chlorine gas DULCO®Vaq in chapter 5 enable high germ destruction speed with low operating costs. Their vacuum technology ensures maximum operating safety.

The **storage tanks** from **chapter 6** are indispensable. They comply with internationally applicable manufacturing approvals and are suitable for installation outdoors and indoors.

The **metering systems Ultromat®** are persuasive with their ease of assembly and operation. They meet the ultimate requirements in terms of the separation of colloidal solids from liquids. They can be found in **Chapter 7**.

When it comes to the reliable removal of particles and salts, we recommend systems with **membrane filter technology** described in **Chapter 8**.

Ready for you. Anytime, anywhere.

ProMinent is close to hand no matter where you are: 55 dedicated sales, production and service companies guarantee service and availability in close proximity to our customers. For many years this has meant a local presence for our customers in over 100 countries.

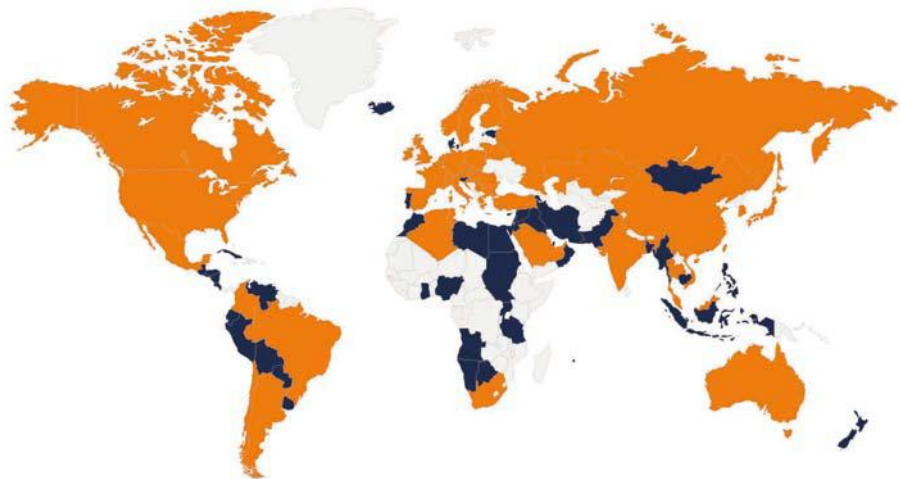

Our sales team will be happy to be of assistance should you have any questions about metering technology or water treatment. You will find the contact details of your local contact at www.prominent.com/en/locations.

Pump Guide

You can also find information online. The ProMinent pump selection guide is available on our website. Just enter the required pump capacity and back pressure, and the Pump Guide will show you a list of suitable metering pumps. This is the quick and easy way to track down precisely the right pump for your needs.

www.pump-guide.com

New Products



Electrolysis system CHLORINSITU® IIa

Output of 30 – 300 g/h sodium hypochlorite

The new CHLORINSITU® IIa combines the proven and durable design of the open electrolysis cell with an innovative design. An exceptional quality of hypochlorite solution is achieved when the salt and power output is increased.

The chlorate content of the product is significantly below the limit value specified in EN 901.

All relevant system components are accommodated in a compact and space-saving housing. Integral hydrogen discharge enables the system to be installed without any need for specific ventilation requirements for the installation place (no ATEX).

The system is immediately ready for use, thanks to the plug-and-play concept. Operation of the electrolysis system has been consciously kept simple.

Available scope of delivery:

- Corrosion-proof housing with ventilation fan
- Control with multicoloured touch panel
- Remote maintenance module
- Salt dissolving tanks outside of the housing
- Integrated product tank with diaphragm metering pump for metering the chlorine solution
- Integrated softener
- Durable design, transparent technology
- Low-chlorate product (below the EN 901 limit value)
- High output
- Excellent safety
- Minimal space requirement
- Minimal maintenance work and ease of operation

For more information see page → 1-1





Automatic chlorine gas metering system DULCO®Vaq

Capacity: 12 g/h – 15 kg/h

The automatic chlorine gas metering system DULCO®Vaq type PM 3610 C is fitted in the vacuum system between the vacuum controller and injector. The chlorine gas flow is automatically adjusted. A stepper motor controls an ultra-precise V-nozzle, enabling a linear control characteristic over a wide range. Control is by means of external control, such as analogue signals, 0/2 - 10 V, Modbus or by manually setting on the device's keypad. Opening and operating statuses are signalled externally by analogue and digital outputs and by LEDs on the device. In the event of power failure, the valve closes automatically, although mechanical manual operation is possible. The flow of chlorine gas is displayed on a long-scale flow meter and is held constant by the integrated differential pressure regulator even with fluctuating pressure conditions.

Manometers display both the injector vacuum as well as the operating vacuum.

The entire system is ready-wired and mounted on a PVC panel and protected by an appropriate cover.

- Automatic chlorine gas metering
- Plug and Play
- DIN 19606-compliant
- Panel-mounted system
- Wide-ranging controllable motorised control valve
- Functional cover hood

For more information see page → 1-2

Metering system PolyRex Big Bag

Capacity range of up to 8,200 l/h

The upper storage tank prepares the batching/ maturing tank. The lower tank is the storage tank for the prepared polymer solution.

The powdered polymer is transported to the powder feeder by a vacuum conveyor using 2 conveyor screws and mixed into 3 layers with water in the underlying mixer unit; wetting cone, water injector and stirrer in batching tank. The solution is then transferred to the upper storage tank using the water pressure of the diluting water. The polymer solution matures completely in this, a short circuit effect is avoided. After maturing, the solution can be transferred to the lower storage tank via the motorised valve.

Compact controller ABB AC500 PM573-ETH and Touchpanel CP635

- Flexible and height-adjustable Big Bag emptying system with integrated spider clamp for loading with crane or forklift
- Double-screw feeder with 2 reverse conveyor screws enables low-pulsation metering with a high level of dosing precision
- Pressure reducer provides for a constant water supply
- Effective 3-phase mixing of polymer solution
- No short circuit effect, polymer particles cannot pass through the process without being activated

For more information see page → 1-2

Metering system PolyRex Liquid

Capacity range of up to 3,180 l/h

The upper storage tank is the batching/maturing tank. The lower tank is the storage tank for the prepared polymer solution.

The liquid polymer is fed in by an eccentric screw pump and an injection nozzle and mixed with water in 2 stages by means of a water injector and a stirrer in the batching/maturing tank. The solution is transferred to the upper storage tank using the water pressure of the diluting water. The polymer solution can fully mature in this, avoiding a short-circuiting effect. After maturing, the solution can be transferred to the bottom storage tank via the motorised valve.

Compact controller ABB AC500 PM573-ETH and touch panel CP635

- Reliable eccentric screw pump for the metering of commercially available polymers
- High energy mixing process
- Unique injection nozzle prevents clogging of the liquid polymer
- Pressure reducer provides for a constant water supply
- Effective 2-phase mixing of the polymer solution
- No short-circuiting effect: polymer particles cannot pass through the process without activation

For more information see page → 1-2



P_UL_0039_SW

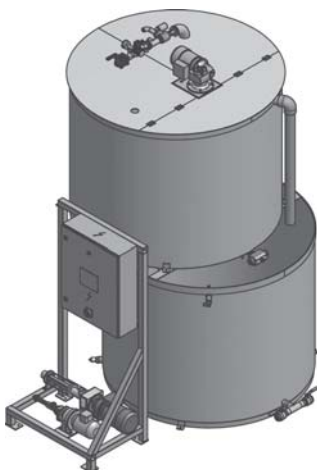

P_UL_0038_SW

Water Treatment and Water Disinfection

page

1	UV Systems Dulcodes	1-1
1.1	General Notes on UV Treatment	1-1
1.1.1	Applications of Dulcodes UV Systems	1-1
1.1.2	Description of Dulcodes UV Systems	1-2
1.2	Performance Overview of Dulcodes UV Systems	1-4
1.2.1	Notes on Planning and Designing an UV System	1-5
1.3	Questionnaire for Designing an UV System	1-6
1.4	UV System Dulcodes LP	1-7
1.5	UV system Dulcodes LP certified	1-9
1.6	UV System Dulcodes LP-PE Plastic	1-11
1.7	UV System Dulcodes MP	1-13
1.8	UV System Dulcodes A	1-15
1.9	Accessories for Dulcodes UV Systems	1-17
2	Ozone Systems OZONFILT®	2-1
2.1	Ozone In Water Treatment	2-1
2.2	Performance Overview of Ozone Systems	2-2
2.3	Questionnaire on the Design of an Ozone System	2-3
2.4	Ozone System OZONFILT® OZVa	2-4
2.4.1	OZONFILT® OZVa 1-4 Ozone Generation Systems (Process Gas - Air)	2-5
2.4.2	OZONFILT® OZVa 5-7 Ozone Production Systems (Operating Gas - Oxygen)	2-7
2.4.3	System Solution OZONFILT® Compact OMVa	2-11
2.5	Ozone System OZONFILT® OZMa	2-13
2.5.1	Ozone Generation Systems OZONFILT® OZMa 1-6 A (Operating Gas - Air)	2-15
2.5.2	Ozone Generation Systems OZONFILT® OZMa 1-6 O (Operating Gas - Oxygen)	2-18
2.5.3	Ordering Information for OZONFILT® OZMa Systems	2-21
2.6	Accessories and Spare Parts for Ozone Systems	2-22
2.6.1	Compressors for OZONFILT® OZVa 1-4	2-22
2.6.2	Oxygen generator for OZONFILT® OZVa 5-7 and OZMa10	2-23
2.6.3	Static Helical Mixer Made of PVC or Stainless Steel	2-24
2.6.4	Accessories for OZONFILT® OZMa	2-25
2.6.5	Bleed Valves	2-25
2.6.6	Residual Ozone Gas Destructor	2-25
2.6.7	Room Air Monitoring	2-26
2.6.8	Cooling Water Heat Exchanger	2-27
2.6.9	Personal Protection Accessories	2-28
2.6.10	Overvoltage Protection	2-28
2.6.11	Replacement Plug-in Insert After Tripping	2-28
3	Bello Zon® Chlorine Dioxide Systems	3-1
3.1	Chlorine Dioxide in Water Treatment	3-1
3.1.1	Chlorine Dioxide Applications	3-1
3.1.2	Bello Zon® System Technology	3-2
3.2	Performance Overview of Chlorine Dioxide Systems	3-3
3.3	Questionnaire on the Design of a Chlorine Dioxide System	3-4
3.4	Chlorine Dioxide System Bello Zon® CDLb	3-5
3.4.1	Identity code ordering system for chlorine dioxide systems Bello Zon® CDLb	3-7
3.4.2	Accessories and Maintenance Sets for Chlorine Dioxide Systems Bello Zon® CDLb	3-7
3.5	Chlorine Dioxide System Bello Zon® CDLb with Multiple Points of Injection	3-11
3.6	Chlorine Dioxide System Bello Zon® CDEb	3-12
3.7	Chlorine Dioxide System Bello Zon® CDVc	3-14
3.7.1	Identity Code Ordering System for CDVc Systems	3-16
3.7.2	Maintenance Sets for Bello Zon® CDV Chlorine Dioxide Systems	3-17

Water Treatment and Water Disinfection

page

3.8	Chlorine Dioxide System Bello Zon® CDKc	3-18
3.8.1	Identity Code Ordering System for CDKc Systems	3-20
3.8.2	Maintenance Kits for Bello Zon® Type CDK Chlorine Dioxide Systems	3-21
3.9	Storage Tank Accessories	3-22
3.10	Bypass Line Accessories	3-23
3.11	Chemical Supply Accessories	3-26
3.12	Safety Accessories and Analysis	3-28
4	Electrolysis Systems CHLORINSITU® and DULCO®Lyse	4-1
4.1	Electrolysis Systems CHLORINSITU®	4-1
4.2	Performance Overview	4-2
4.3	Questionnaire on the Design of an Electrolysis System	4-3
4.4	Electrolysis system CHLORINSITU® IIa	4-4
4.4.1	Identity code ordering system for electrolysis systems CHLORINSITU® IIa	4-5
4.5	Electrolysis System CHLORINSITU® II	4-6
4.6	Electrolysis System CHLORINSITU® III	4-8
4.7	Electrolysis Systems CHLORINSITU® III Compact and IV Compact	4-10
4.7.1	Electrolysis System CHLORINSITU® III Compact	4-10
4.7.2	Electrolysis System CHLORINSITU® IV Compact	4-12
4.8	Electrolysis System CHLORINSITU® V	4-14
4.9	Electrolysis System CHLORINSITU® V Plus	4-16
4.10	Questionnaire on the design of a DULCO®Lyse electrolysis system	4-18
4.11	Electrolysis System Dulco®Lyse	4-19
4.12	Accessories	4-21
5	Chlorine Gas Metering Systems DULCO®Vaq	5-1
5.1	General Information on Chlorine Gas Metering Systems	5-1
5.1.1	Chlorine Gas Metering Systems DULCO®Vaq	5-1
5.2	Performance Overview of Chlorine Gas Metering Systems DULCO®Vaq	5-2
5.2.1	Instructions on the planning and design of a chlorine gas metering system	5-2
5.3	Questionnaire on the Design of a Chlorine Gas Metering System	5-3
5.4	Vacuum dosing regulator for chlorine gas DULCO®Vaq	5-4
5.4.1	Identity code ordering system for vacuum metering controller DULCO®Vaq	5-6
5.4.2	Vacuum controller accessories	5-6
5.5	Motor-driven control valve for chlorine gas DULCO®Vaq	5-7
5.6	Vacuum switch-over for chlorine gas DULCO®Vaq	5-9
5.7	Injector for Chlorine Gas DULCO®Vaq	5-11
5.8	Flow Meter for Chlorine Gas DULCO®Vaq	5-13
5.9	Automatic emergency shut-off system for chlorine gas DULCO®Vaq	5-14
5.10	Automatic chlorine gas metering system DULCO®Vaq	5-15
5.11	Accessories	5-16
5.11.1	Accessories for chlorine gas metering	5-16
5.11.2	Accessories for room and safety equipment	5-18
5.11.3	Other accessories	5-21
5.11.4	Personal safety equipment	5-22
5.11.5	Drum manifold accessories	5-24
6	Storage Tanks	6-1
6.1	PE/PP Storage Tanks	6-1
6.2	PE Storage Tank With General WHG Approval	6-1
6.2.1	Our standard equipped storage tanks and collecting pans with approval marks	6-3
6.2.2	Accessories Meeting The Requirements Of WHG § 19 and VAWS (Directive On Systems For Storage And Handling Of Water-Endangering Substances)	6-4
6.2.3	Other Accessories	6-6
6.3	PP/PE Storage Tanks, Custom-built	6-7

Water Treatment and Water Disinfection page

7	Polymer Preparation and Metering Systems Ultromat[®], PolyRex and POLYMORE	7-1
7.1	Polyelectrolytes in Water Treatment	7-1
7.2	Performance Overview of Polymer Preparation and Metering Systems Ultromat [®] , PolyRex and POLYMORE	7-2
7.3	Questionnaire for the Design of Polymer Preparation and Metering Systems Ultromat [®] , PolyRex and POLYMORE	7-3
7.4	Preparation Stations and Metering of Powdered and Liquid Polymer Solutions Ultromat [®]	7-4
7.4.1	Application Example for a ULFa Polymer Preparation System	7-4
7.5	Metering System Ultromat [®] ULFa	7-5
7.5.1	Identity Code Ordering System for Continuous Flow Systems Ultromat [®] ULFa	7-7
7.6	Metering System Ultromat [®] ULPa	7-8
7.6.1	Identity Code Ordering System for Oscillating Systems Ultromat [®] ULPa	7-10
7.7	Metering System Ultromat [®] ULDa	7-11
7.7.1	Identity Code Ordering System for Double-deck System Ultromat [®] ULDa	7-13
7.8	Metering System Ultromat [®] MT for Batch Operation	7-14
7.9	Ultromat [®] Accessories including Big Bag Systems	7-15
7.10	Preparation Stations and Metering of Powdered and Liquid Polymer Solutions PolyRex and POLYMORE	7-18
7.10.1	Application Example for a PolyRex Polymer Preparation System	7-18
7.11	Metering System PolyRex	7-19
7.12	Metering System PolyRex Big Bag	7-21
7.13	Metering System PolyRex Liquid	7-23
7.14	Metering System POLYMORE	7-24
7.15	PolyRex accessories – Mixing Systems	7-25
8	Membrane Technology and Membrane Filtration	8-1
8.1	Overview of Membrane Technology	8-1
8.2	Performance Overview of Ultrafiltration	8-2
8.3	Nanofiltration System Dulcosmose [®] NF	8-4
8.4	Performance Overview of Reverse Osmosis	8-6
8.5	Questionnaire	8-8
8.5.1	Questionnaire on the Design of a UF System	8-8
8.5.2	Questionnaire on the Design of an RO System	8-9
8.6	Ultrafiltration System Dulcoclean [®] UF	8-10
8.6.1	Ultrafiltration Systems Dulcoclean [®] UF	8-10
8.7	Reverse Osmosis System Dulcosmose [®]	8-11
8.7.1	Reverse Osmosis System Dulcosmose [®] ecoPRO	8-11
8.7.2	Reverse Osmosis System Dulcosmose [®] TW	8-14
8.7.3	Reverse Osmosis System Dulcosmose [®] BW	8-16
8.7.4	Reverse Osmosis System Dulcosmose [®] SW	8-18

1 UV Systems Dulcodes

1.1 General Notes on UV Treatment

Disinfection is a key stage in modern water treatment. UV disinfection is used to an ever increasing extent, as a safe, chemical-free and reliable disinfection process. Extensive research projects and numerous trouble-free operational systems prove the safety and reliability of UV disinfection.

With UV disinfection, the water to be disinfected is exposed to ultraviolet light, which involves a purely physical, chemical-free process for water disinfection.

UV-C light in particular, with a wavelength ranging from 240 to 280 nm, attacks the vital DNA of the bacteria directly. The radiation initiates a photochemical reaction and destroys the genetic information contained in the DNA. The germ loses its reproduction capability and is destroyed. Even parasites, like Cryptosporidia or Giardia, which are extremely resistant to chemical disinfectants, are efficiently inactivated.

Photochemical reactions are triggered in other applications too. The undesirable disinfection by-product in swimming pool water is reduced by UV radiation, as a result of which enormous fresh water savings are achieved. Oxidants, such as ozone, chlorine or chlorine dioxide, are reliably reduced in the production water used in the food and beverage industry, avoiding the need for costly activated charcoal filters.

UV disinfection has many advantages:

- Immediate and safe destruction of germs without the addition of chemicals
- Photochemical reduction of undesirable substances
- No THM or AOX formation, no formation of other undesirable substances
- No impairment of the odour or taste of the water
- No storage and handling of chemicals required
- Effect is independent of pH
- No reaction vessel or reaction tank required
- Minimal space requirement
- Low investment and operating costs with excellent reliability and efficiency

1.1.1 Applications of Dulcodes UV Systems

A large number of our UV disinfection systems have been supplied worldwide, for the most diverse of applications:

- **Private water suppliers and municipal water works**
for the disinfection of potable water
- **Food and beverage industry**
to destroy the germs and bacteria in the water needed for food and beverage production and for the disinfection of process water
to reduce chlorine dioxide or ozone in water
- **Pharmaceutical and cosmetics industry**
to meet the high microbiological requirements of the production water
to destroy residual ozone in the production water without the use of active carbon filters
- **Reverse osmosis systems**
for permeate disinfection
- **Horticulture**
for the disinfection of irrigation water
- **Spa pools and swimming pools**
for the disinfection of the pool water
for chloramine reduction in the pool water

1 UV Systems Dulcodes

1.1.2

Description of Dulcodes UV Systems

Dulcodes UV disinfection systems essentially consist of:

- High-quality reactor made of stainless steel (DIN 1.4404) or UV-resistant plastic
- Lamp protection tubes made of high-quality quartz, easily removable for cleaning purposes
- Lamps with an exceptionally high UV output in the 254 nm range
- Highly selective UV sensors with good long-term and temperature stability
- UV system controllers and modern electronic ballasts fitted in a control cabinet

The special features of our Dulcodes UV disinfection systems are:

- Uniform UV dose distribution thanks to optimised flow characteristic in the reactor guarantees maximum flow output with a minimum lamp count and minimum pressure loss
- Reduced life cycle costs due to the long life time of high-output lamps with low energy consumption and high UV output
- Unique active temperature management of Vario-flux low-pressure technology adapts the lamp output in seconds and provides optimum disinfection even with rapidly changing flows and temperature conditions
- Efficient and chemical-free cleaning of the lamp protection tubes with manual or automatic wiper system without interruption to operation
- Continuous monitoring of the reactor temperature by temperature sensor Pt 1000
- Electronic ballasts for the soft start and operation and monitoring of individual lamps
- Dulcodes LP control cabinet with efficient recirculation cooling ensures the long life of electronic components and protects against corrosion in aggressive ambient conditions
- Various options for simple integration of the unit in higher-level control systems thanks to many analogue and digital interfaces
- User-friendly and intuitive control for the display of operating statuses and adjustment of operating parameters
- Comprehensive biosimetric validation in line with EPA-UVDGM or DVGW and ÖVGW certification for selected product ranges confirm disinfection efficiency

Dulcodes UV Lamps

Low-pressure lamp Vario-Flux

Newly developed patented high-output amalgam lamp with a guaranteed expected lamp life of 14,000 operating hours (pro rata). The lamps stand out on account of their high UV output and minimal ageing behaviour. Thanks to the unique combination of electronic ballast technology and the Vario-Flux lamps, they can be controlled quickly and precisely over a broad range of up to 50 % of the nominal power. Seasonal fluctuations of water temperature no longer play a role and are simply compensated for by the active temperature management of the lamp. Efficiency increases even in dimmed mode. This has a particularly positive effect when the actual flow is below the maximum possible flow of the system. The special technology also enables vertical and horizontal installation.

Medium-pressure lamp Powerline

Medium-pressure mercury lamp with a life expectancy of approx. 8,000 to 10,000 operating hours, depending on the lamp size. The high output of these lamps permits the treatment of very large flows. Thanks to their broad range spectrum, these lamps are particularly suitable for photochemical processes. The operating temperature of the lamps is 650 – 850 °C. The water temperature is therefore monitored and the system switches off when a limit temperature is exceeded.

1 UV Systems Dulcodes

Dulcodes UV Controllers

Compact controller

Compact unit for the control of all functions of the UV system. The control can be selected for single lamp systems of the Dulcodes LP product range. The display alternately shows the current UV-intensity, the operating hours and the number of lamp activations. The compact controller informs the operator if values fall below freely programmable safety and warning thresholds. Different functions, such as start rinsing, interval rinsing, stagnation rinsing and post-burning time can be freely set on demand.

The control has the following inputs and outputs:

- Connection for both a rinsing and shut-off valve (230 V)
- Potential-free contact output for the end of lamp life, power failure and warning
- Potential-free changeover output for operating and collective failure messages
- Potential-free contact input for temperature or flow control and pause
- 4-20 mA analogue output for sensor signal

Comfort controller UVCb

The Comfort controller consists of a control PCB and a HMI which is integrated in the door of the control cabinet. The control of the UV systems is user-friendly and intuitive. All operating statuses are shown on the display and all operating and fault messages are shown in plain text. The operating status (Operation/Warning/Fault) of the system can be seen from afar by means of LEDs.

The Comfort controller UVCb is connected to the ballasts via a bus system so that each individual lamp can be precisely monitored. Different cable lengths are detected automatically and the operating parameters adapted accordingly. The controller, the electronic ballasts and the lamps are perfectly matched to each other. This enables the system to adapt the UVC-output of the low pressure and medium pressure lamp to variable water quality or flow rates via an external 0/4-20 mA signal.

Different auxiliary functions, such as the automatic rinsing of the system over a freely programmable rinsing time, the control of a shut-off valve and a circulating pump are integrated as standard. The controller is managing as well the automatic wiper system. During the wiping cycle, the position is multiple controlled for absolute operational safety of the wiper system: by monitoring the end position and by continuous data exchange between the wiper motor and the controller.

The UVC sensor signal can be monitored online via an analogue output 0/4-20 mA. Any violation of the warning threshold, minimum radiation intensity and faults are reported via contact outputs. The reactor temperature is monitored by a temperature sensor to avoid overheating.

Potential-free inputs make it possible to hook up the UV-system to a higher order control: The "Pause" input can be used to regularly start/stop the system, with the "External fault" input leading to the system being shut down in the event of a fault with an external peripheral component connected. If the application requires different UV doses, a contact input can quickly adapt the UV dose to the changing requirement.

The Comfort controller UVCb features data logger. All events are saved on an SD card and can simply be read off on a PC. The UV sensor signal and other measuring parameters, connected to the control via external 0/4-20 mA signals, are stored on the SD card at set time intervals.

The control has the following inputs and outputs:

- 3 voltage outputs for rinsing and shut-off valve and pump (230 V or 24 V)
- 3 potential-free outputs for warning, collective malfunction and operating messages
- 4 potential-free inputs for pause, external fault, activate emergency mode, setpoint 1/2 switchover
- 1 analogue output 0/4-20 mA for sensor signal
- 2 analogue inputs 0/4-20 mA for flow and turbidity or combined chlorine with limit value function
- CAN-bus interface for the integration of higher-level controls

Dulcodes A comfort controller

A Siemens S7- 1200 control with a KP 300 Basic operating unit is used for operation and control of Dulcodes A systems. The functionality corresponds to that of the Comfort controller UVCb.

1 UV Systems Dulcodes

1.2 Performance Overview of Dulcodes UV Systems

ProMinent offers a wide range of UV systems for the most diverse applications. The following overview shows the capacity and main applications of our standard systems:

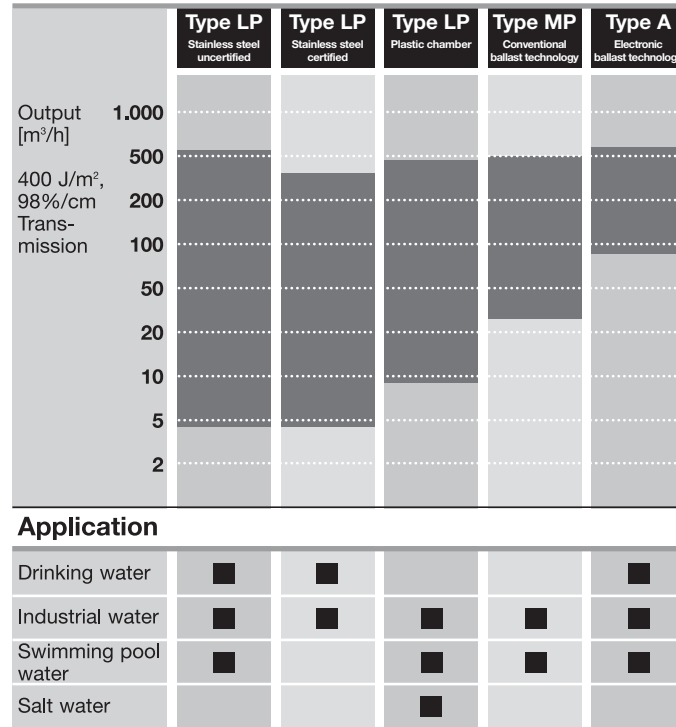

P_PMA_DS_0030_SW

Type LP: Low-pressure systems

Type MP: Medium-pressure systems

ProMinent provides all the advice needed for the safe operation of a Dulcodes UV system:

- Evaluation of the situation on site by trained, expert field sales staff.
- Project planning of the system.
- Commissioning and system maintenance by our trained service technicians.

1 UV Systems Dulcodes

1.2.1

Notes on Planning and Designing an UV System

- The system should always be designed for the maximum water flow.
- The system should always be designed for the worst anticipated UV transmission.
- Flammable sampling cocks for microbiological sampling should be provided upstream and downstream of UV disinfection systems.
- A manual shut-off valve should be provided before the UV system to isolate the system for maintenance work.
- With potable water disinfection and similar applications, an electrically-controlled shut-off valve should be provided downstream of the UV disinfection system, which also closes automatically on mains failure (solenoid valve, automatic closing flap valve or similar).
- With service water disinfection, it is normally sufficient to provide a manual valve to isolate the system for maintenance work, instead of the electrically-controlled valve.
- With potable water disinfection and similar applications, a flushing valve should be provided downstream of the UV disinfection.
- It should be ensured that there is sufficient space available for removing the lamp protection tube and lamp replacement.

- 1 Shut-off valve
- 2 Sampling cock
- 3 Flushing valve
- 4 Shut-off valve
- 5 Controller/ballast
- 6 Radiation chamber

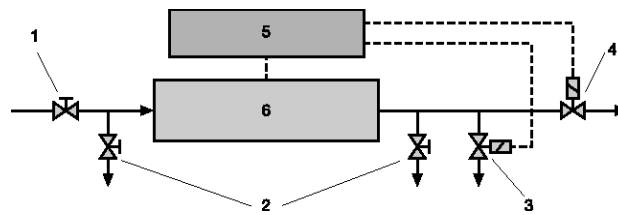

pk_7_059

Typical installation diagram of a UV disinfection system

The following details are required for design of a UV system:

- Application of the system
- Maximum water flow
- Minimum UV transmission of the water

The UV transmission should be determined by means of a laboratory measurement of the absorption at 254 nm.

A full water analysis gives important conclusions on the operating conditions of the system. The following questionnaire provides our project engineers with the information needed to design an appropriate system.

1 UV Systems Dulcodes

1.3 Questionnaire for Designing an UV System

Application of the UV system:

- for disinfection of
 - drinking water
 - production water in the food industry, cosmetics or pharmaceuticals
 - utility water
 - wastewater
 - salt water or brackish water
 - _____
- for photochemical reduction of
 - ____ ppm ozone
 - ____ ppm chlorine dioxide
 - ____ ppm chlorine
 - ____ ppm chloramine

Water data:

Maximum water flow _____ m³/h Maximum water pressure _____ bar

Minimum UV transmission at 254 nm _____ %/1 cm _____ %/10 cm _____ SAC 254 nm

Turbidity _____ FNU _____ NTU

Suspended particles content _____ mg/l

Water quality constant fluctuating

Total hardness _____ mmol/l _____ °dH

Carbonate hardness _____ mmol/l _____ °dH

Chloride _____ mg/l

Manganese _____ mg/l

Iron _____ mg/l

Water temperature _____ °C

Other requirements:

1

1 UV Systems Dulcodes

1.4 UV System Dulcodes LP

A world first: precise lamp dimming in seconds – even with varying flows and water temperatures.

Flow up to 523 m³/h

The unique UV systems Dulcodes LP are synonymous with pioneering water treatment – efficient and free of chemicals.

Our patented Vario-Flux high-output lamps with dynamic lamp heating are used in the Dulcodes LP. Thanks to the unique combination of electronic ballast technology and the Vario-Flux lamps, they can be quickly and precisely dimmed over a broad power range of up to 50% of the nominal electrical power. This ensures automatic adjustment to varying flows and water temperatures at all times.

Efficiency even increases in dimmed mode, which has a particularly positive effect when the actual flow is below the maximum possible flow of the system.

The flow in the Dulcodes LP has been optimised in a reactor based on intensive computer simulation. At the same time the pressure loss is kept minimal. The resulting uniform radiation dose without over- or under-metering of a partial volumetric flow leads to minimal use of energy, a minimum number of lamps and significantly reduced life cycle costs.

Your benefits

- UV system Dulcodes LP for a broad field of application for efficient, safe and chemical-free water disinfection
- Unique dynamic lamp heating adjusts the lamp output in seconds and provides for optimum disinfection even with rapidly varying flows and water temperatures
- Homogeneous UV dose, thanks to optimised flow characteristics in the reactor, guarantees maximum flow output with a minimum number of lamps and minimum pressure loss
- Reduced life cycle costs due to the long service life of Vario-Flux high-output lamps with low energy consumption and high UV output
- High flexibility thanks to vertical or horizontal installation and free choice of the flange position
- User-friendly and intuitive control for the display of operating statuses and adjustment of operating parameters
- Control cabinet with efficient recirculation cooling ensures the long life of electronic components and protects against corrosion in aggressive ambient conditions
- Data logger: all relevant operating data and all events are saved on the SD card and can simply and conveniently be visualised with an analysis programme
- Simple remote monitoring and remote control of the system by means of web-based access via LAN/WLAN interface

Technical Details

- CFD (Computational Fluid Dynamics) optimised reactor made of high-grade stainless steel 1.4404/ AISI316L by means of computer simulation
- High-output amalgam lamp "Vario-Flux" with dynamic lamp heating
- Guaranteed lamp service life of 14,000 operating hours (pro rata)
- Electronic ballasts for the gentle ignition, operation and individual monitoring and control of the lamps
- Long-term stable UVC sensor for continuous monitoring of the system
- Efficient and chemical-free cleaning of the cover tubes with manual or automatic wiper system, optionally available for selected system sizes
- Continuous monitoring of the water temperature by temperature sensor Pt 1000
- Single lamp system: equipped with either a Compact controller or Comfort controller
- Various options for simple integration of the system in higher-level control systems thanks to many analogue and digital interfaces and connectors
- Data logger: all relevant operating data and all events are saved on the SD card and can simply and conveniently be visualised with an analysis programme
- DULCOnnect module enables simple remote monitoring and remote control of the system by means of web-based access via LAN/WLAN interface. The current system status can be displayed at any time on a terminal unit

Field of application

- Potable water treatment
- Food and beverage production
- Swimming pool water



P_PMA_DS_0031_SW

1 UV Systems Dulcodes

Design versions

The Dulcodes LP systems are available in the following design versions:

Type	Compact controller	Comfort controller	System control	Wiper	Stainless steel control cabinet	Air-conditioned control cabinet	NSF 50-certified	UL/CSA-compliant
Dulcodes 1 x 80 LP	Yes	No	No	No	No	No	No	No
Dulcodes 1 x 230 LP	Yes	Yes	Yes	No	Yes	Yes	Yes	Yes
Dulcodes 1 x 350 LP	Yes	Yes	Yes	Yes	Yes	Yes	Yes	Yes
Dulcodes 2 x 350 LP	No	Yes	Yes	Yes	Yes	Yes	Yes	Yes
Dulcodes 3 x 230 LP	No	Yes	Yes	No	Yes	Yes	Yes	Yes
Dulcodes 3 x 350LP	No	Yes	Yes	Yes	Yes	Yes	Yes	Yes
Dulcodes 4 x 350 LP	No	Yes	Yes	Yes	Yes	No	No	Yes
Dulcodes 6 x 350 LP	No	Yes	Yes	No	Yes	No	No	Yes

Technical Data

Type	Max. flow m ³ /h	Lamp power W	Connected load W	Reactor length mm	Minimum clearance for service mm	Ø mm	Connection nominal diameter
Dulcodes 1x80LP	8.8*	85	110	872	973	140	RP 2" / RP 2"
Dulcodes 1x230LP	35*	270	310	1,151	1,064	140	DN 80 / 3"
Dulcodes 1x350LP	53*	380	430	1,640	1,465	168	DN 100 / 4"
Dulcodes 2x350LP	123*	2x380	835	1,640	1,465	256	DN 150 / 6"
Dulcodes 3x230LP	155*	3x270	825	1,185	1,156	324	DN 150 / 6"
Dulcodes 3x350LP	232*	3x380	1,240	1,885	1,565	324	DN 200 / 8"
Dulcodes 4x350LP	317*	4x380	1,645	1,885	1,565	356	DN 200 / 8"
Dulcodes 6x350LP	523*	6x380	2,455	1,885	1,565	406	DN 250 / 10"

** 98 %/cm transmission; 400 J/m² irradiation intensity, calculated according to PSS.

Lamp type	Low-pressure lamp Vario Flux
Controller type	Comfort controller, optionally compact controller
Permissible operating pressure	10 bar or 16 bar
Permissible ambient temperature	5 – 40 °C
Permissible water temperature	2 – 70 °C
Enclosure rating	IP 66

Low-pressure lamp Vario Flux (see p. → 1-2)

Comfort controller, optionally compact controller (see p. → 1-3)

Spare Parts For Dulcodes LP UV Systems

	Order no.
UV lamp Vario Flux 80 W	1061751
UV lamp Vario Flux 230 W	1061752
UV lamp Vario Flux 350 W	1061418
Lamp protection tube for Dulcodes 1x80LP	1059182
Lamp protection tube for Dulcodes 1x230LP	1058838
Lamp protection tube for Dulcodes 1x350 and 2x350LP	1049344
Lamp protection tube for Dulcodes 3 – 6x350LP	1049350
O-ring lamp protection tube/lamp cover for 1x80LP	1004920
O-ring lamp protection tube for 1x230 to 6x350LP	1023569
UVC sensor	1075544
Screwed plug G 1/2" for Dulcodes 2 – 6x350LP	1005818
Screwed plug G 1/4" for Dulcodes 1x80 to 1x350LP	1002752
O-ring for G 1/4" screwed plug for Dulcodes 1x80 to 1x350LP	1001356
O-ring for G 1/2" screwed plug for Dulcodes 2 – 6x350LP	1002279

1.5 UV system Dulcodes LP certified

Global first in the chemical-free disinfection of potable water – now also certified

Flow up to 410 m³/h



UV system Dulcodes LP for potable water disinfection, comprehensively certified to internationally-recognised DVGW / ÖNORM / SVGW / ACS / UVDGM standards. Pioneering water treatment - highly efficient by Vario-Flux lamps with dynamic lamp heating.

The Dulcodes LP is the first UV system to be precisely dimmed over a wide temperature range.

The unique combination of electronic ballast technology and the Vario-Flux lamps enables the system to be quickly and precisely dimmed over a broad power range of up to 50%. It therefore automatically adapts to changing flows or changes of water temperature.

Maximum efficiency and minimal life cycle costs are therefore achieved due to the reduced number of lamps and minimal use of energy.

Optimum flow in the reactors is based on intensive computer simulations. The radiation dose is even without over- or under-metering a partial volumetric flow. At the same time the pressure loss is kept minimal.

Your benefits

- Unique dynamic lamp heating adjusts the lamp output in seconds and provides for optimum disinfection even with rapidly varying flows and water temperatures
- Homogeneous UV dose, thanks to optimised flow characteristics in the reactor, guarantees maximum flow output with a minimum number of lamps and minimum pressure loss
- Reduction of life cycle costs: Use of long service life Vario-Flux high output lamps with low energy consumption and high UV output
- Excellent flexibility: vertical or horizontal installation and free choice of flange position
- Control cabinet with efficient recirculation cooling ensures the long life of electronic components and protects against corrosion in aggressive ambient conditions
- User-friendly and intuitive: The control for the display of operating statuses and adjustment of operating parameters
- Precise documentation: all relevant operating data and events are saved on the SD card and can simply and conveniently be visualised with an analysis programme
- Access from everywhere: Simple remote monitoring and remote control by means of web-based access via LAN/WLAN interface

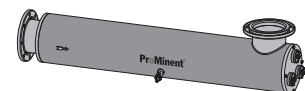

P_PMA_DS_0031_SW

Technical Details

- High-grade stainless steel 1.4404/AISI316L reactor hydraulically optimised by means of computer simulation
- High-output amalgam lamp "Vario-Flux" with dynamic lamp heating
- Guaranteed lamp life of 14,000 operating hours (pro rata)
- Electronic ballasts for the gentle ignition, operation and individual monitoring and control of the lamps
- DVGW/ÖVGW UVC sensor 160° opening angle, highly selective and age-stable, integrated in the measuring window
- Continuous monitoring of the water temperature by temperature sensor Pt 1000
- Single lamp system: equipped with either a Compact controller or Comfort controller
- Various options for simple integration of the system in higher-level control systems thanks to many analogue and digital interfaces and connectors
- Data logger: all relevant operating data and all events are saved on the SD card and can simply and conveniently be visualised with an analysis programme
- DULCOnnect module enables simple remote monitoring and remote control of the system by means of web-based access via LAN/WLAN interface. The current system status can be displayed at any time on a terminal unit.

Field of application

- Potable water treatment
- Food and beverage production

1 UV Systems Dulcodes

Design versions

The certified Dulcodes LP systems are available in the following versions:

Type	Compact controller	Comfort controller	Systems control	Wiper	Stainless steel control cabinet	Control cabinet air-conditioning	UL/CSA compliant
Dulcodes 1x80 LP	Yes	No	No	No	No	No	No
Dulcodes 1x230 LP	Yes	Yes	Yes	No	Yes	Yes	Yes
Dulcodes 1x350 LP	Yes	Yes	Yes	No	Yes	Yes	Yes
Dulcodes 2x350 LP	No	Yes	Yes	No	Yes	Yes	Yes
Dulcodes 3x230 LP	No	Yes	Yes	No	Yes	Yes	Yes
Dulcodes 3x350 LP	No	Yes	Yes	No	Yes	Yes	Yes
Dulcodes 4x350 LP	No	Yes	Yes	No	Yes	No	Yes
Dulcodes 6x350 LP	No	Yes	Yes	No	Yes	No	Yes

Technical Data

Type	Max. flow m ³ /h	Lamp power W	Connected load W	Reactor length mm	Minimum clearance for service mm	Ø mm	Connection nominal diameter
Dulcodes 1x80LP	6.4*	85	110	872	973	140	RP 2" / RP 2"
Dulcodes 1x230LP	20.7*	270	310	1,151	1,064	140	DN 80 / 3"
Dulcodes 1x350LP	40.3*	380	430	1,640	1,465	168	DN 100 / 4"
Dulcodes 2x350LP	113*	2x380	835	1,640	1,465	256	DN 150 / 6"
Dulcodes 3x230LP	86*	3x270	825	1,185	1,156	324	DN 150 / 6"
Dulcodes 3x350LP	189*	3x380	1,240	1,885	1,565	324	DN 200 / 8"
Dulcodes 4x350LP	259*	4x380	1,645	1,885	1,565	356	DN 200 / 8"
Dulcodes 6x350LP	410*	6x380	2,455	1,885	1,565	406	DN 250 / 10"

** 98 %/cm transmission; flows certified to DVGW W 294 / ÖNORM / SVGW / ACS

Lamp type	Low-pressure lamp Vario Flux
Controller type	Comfort controller, optionally compact controller
Permissible operating pressure	10 bar or 16 bar
Permissible ambient temperature	5 – 40 °C
Permissible water temperature	2 – 70 °C
Enclosure rating	IP 66

Low-pressure lamp Vario Flux (see page → 1-2)

Comfort controller, optionally compact controller (see page → 1-3)

Spare Parts For Dulcodes LP UV Systems

	Order no.
UV lamp Vario Flux 80 W	1061751
UV lamp Vario Flux 230 W	1061752
UV lamp Vario Flux 350 W	1061418
Lamp protection tube for Dulcodes 1x80LP	1059182
Lamp protection tube for Dulcodes 1x230LP	1058838
Lamp protection tube for Dulcodes 1x350 and 2x350LP	1049344
Lamp protection tube for Dulcodes 3 – 6x350LP	1049350
O-ring lamp protection tube/lamp cover for 1x80LP	1004920
O-ring lamp protection tube for 1x230 to 6x350LP	1023569
UVC sensor DVGW/ÖVGW 160°	1076149
O-ring UVC sensor window	1076121
Screwed plug G 1/2" for Dulcodes 2 – 6x350LP	1005818
Screwed plug G 1/4" for Dulcodes 1x80 to 1x350LP	1002752
O-ring for G 1/4" screwed plug for Dulcodes 1x80 to 1x350LP	1001356
O-ring for G 1/2" screwed plug for Dulcodes 2 – 6x350LP	1002279

1 UV Systems Dulcodes

1.6 UV System Dulcodes LP-PE Plastic

Chemical-free and reliable disinfection of water containing salt, such as sea water or thermal water.

Flow up to 505 m³/h



Disinfection of saline sea water or thermal water with corrosion resistant reactor the UV system Dulcodes LP-PE. The UV system consists of a reactor and a UV sensor made of highly UV-resistant plastic.

The UV system Dulcodes LP-PE plastic is absolutely corrosion-free. This is ensured by the UV-stabilised, highly compressed HD-PE reactor and a special sensor made of plastic. The reactor is temperature-resistant through a special welding process and optimised to a pressure rating of up to 4 bar. Our patented Vario-Flux high-output lamps with dynamic lamp heating are used in our LP-PE systems. We achieve an extremely high UVC efficiency, thanks to the unique combination of electronic ballast technology and the Vario Flux lamps.

Your benefits

- Reactor made of UV-stabilised high-density HD-PE, absolutely corrosion-free and temperature stable.
- Long-term salt water-resistant UVC sensor for monitoring the disinfection capacity, contamination of the lamp protection tubes, lamp ageing and water transmission.
- Highly efficient Vario Flux 350 W lamps provide for maximum disinfection and flow rate with a minimum number of lamps.
- Electronic ballasts for the gentle ignition, operation and individual monitoring of the lamps.
- The replacement of lamps is reduced to the absolute minimum.
- Low maintenance costs and low follow-on costs, as there are fewer, high-performance lamps featuring amalgam technology with an excellent service life of up to 14,000 hours.
- Excellent flexibility thanks to vertical or horizontal installation.
- Data logger: all relevant operating data and all events are saved on the SD card and can simply and conveniently be visualised with an analysis programme.
- Simple remote monitoring and remote control of the system by means of web-based access via LAN/WLAN interface.

Technical Details

- Reactor made of UV-stabilised high-density HD-PE
- High-performance and highly efficient low-pressure amalgam lamps Vario Flux with dynamic lamp heating
- Guaranteed (pro rata) lamp life: 14,000 hours of operation
- Long-term stable UVC sensor made of PTFE for continuous monitoring of the system, factory-calibrated in accordance with the DVGW standard.
- Control cabinet made of coated steel
- Single lamp system: equipped with either a Compact controller or Comfort controller UVCb
- Various options for simple integration of the system in higher-level control systems thanks to many analogue and digital interfaces and connectors
- Data logger: all relevant operating data and all events are saved on the SD card and can simply and conveniently be visualised with an analysis programme.
- DULCConnect module enables simple remote monitoring and remote control of the system by means of web-based access via LAN/WLAN interface. The current system status can be displayed at any time on a terminal unit.

Field of application

- Process water
- Swimming pool water
- Salt water

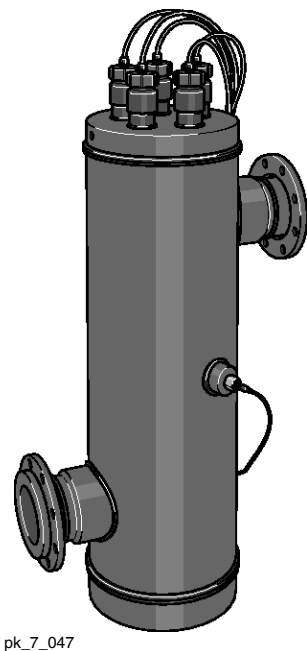

pk_7_047

1 UV Systems Dulcodes

Technical Data

Type	Max. flow m ³ /h	Lamp power W	Connected load W	Reactor length mm	Minimum clearance for service mm	Ø mm	Connection nominal diameter
1x350LP-PE	35*	1x380	430	1,590	1,565	140	DN 80
2x350LP-PE	123*	2x380	835	1,590	1,565	280	DN 125
3x350LP-PE	252*	3x380	1,240	1,590	1,565	400	DN 200
4x350LP-PE	328*	4x380	1,645	1,590	1,565	400	DN 200
6x350LP-PE**	505*	6x380	2,455	1,590	1,565	500	DN 300

* 98%/cm transmission; 400 J/m² radiation intensity

** permissible operating pressure 3 bar

Lamp type	Low-pressure lamp Vario Flux
Controller type	Comfort controller, optionally compact controller
Permissible operating pressure	4 bar
Permissible ambient temperature	5 – 40 °C
Permissible water temperature	5 – 30 °C
Enclosure rating	IP 66

Low-pressure lamp Vario Flux (see page → 1-2)

Comfort controller, optionally compact controller (see p. → 1-3)

Spare parts for Dulcodes LPPE UV systems

	Order no.
UV lamp Vario Flux 350 W	1061418
Lamp protection tube for Dulcodes LP PE systems	1026694
O-ring lamp protection tube for 1x230 to 6x350LP	1023569
O-ring lamp cover	1006332
O-ring sensor K, PTFE	1035201
O-ring for UVC sensor K, PTFE	1041049

1 UV Systems Dulcodes

1.7 UV System Dulcodes MP

Effective solution for the treatment of swimming pool water – designed for the decomposition of combined chlorine.

Flow up to 569 m³/h



The UV system Dulcodes MP is used for the efficient breakdown of combined chlorine in swimming pools, eliminating the typical swimming pool odour: no more irritation for eyes, nose and skin. Apart from improving the water quality, the lower investment costs and high fresh water and energy consumption savings result in shorter payback times.

The UV system Dulcodes MP is fitted with output-optimised medium-pressure lamps, which guarantee the efficient photochemical breakdown of combined chlorine in swimming pool water. The system is insensitive to the most adverse conditions in warm, humid plant rooms enriched by aggressive chemicals. The robust system technology remains completely unaffected by this.

Efficient cleaning of the lamp protection tubes during operation is possible with ease. The lamp protection tubes can either be cleaned by a manual wiper or by the optionally extendible motor-driven automatic wiper.

The Dulcodes MP is a compact inline system. Thanks to its flexible flange options, the system can be used with ease for different nominal widths of circulation rate. The UV reactor is designed in such a way that no UV radiation can escape from the reactor. This means that the system can be installed directly in a plastic pipe. The free choice of the fitting position simplifies installation and retrofitting in the extreme.

Your benefits

- Simple installation, thanks to the compact inline system, ensures minimum installation costs and fast retrofitting.
- Maximum flexibility when installing, thanks to free choice of the fitting position and direct installation in plastic pipes, as no UV radiation escapes from the reactor.
- Automatic switching on and off based on the chloramine value, for example used in conjunction with the DULCOMARIN® II.
- Unbeatably simple and quick maintenance: all maintenance work can be carried out quickly and conveniently from one side.
- Manual power control for optimum adaptation of the system to the respective capacity requirement (not for Dulcodes 1 x 0.65MP and 1MP).
- Manual or automatic wiper system for the efficient removal of deposits on the lamp protection tube. The wiper system can be easily retrofitted.

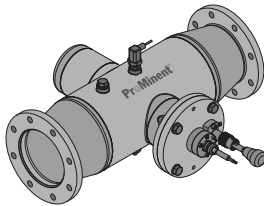

P_PMA_DS_0032_SW

Technical Details

- Integral temperature switch to monitor the water temperature in the radiation chamber.
- NSF 50-certified and specifically recommended for use in swimming pools.
- Optimised use of energy, thanks to large radiation chamber and uniform irradiation of the entire water flow due to optimised system hydraulics.
- Radiation chambers made of high-grade stainless steel 1.4404/AISI316L.
- Long-term stable UVC sensor for monitoring the lamp output, dirt on the lamp protection tube and changes in water quality.
- Powerline medium-pressure lamps with high connecting power of up to 3 kW.
- Manual or automatic motor-driven wiper for the efficient removal of deposits on the lamp protection tube.
- Guaranteed (pro rata) lamp service life of 8,000 hours.
- Comfort controller with various options for simple integration of the plant in higher-level control systems, thanks to many analogue and digital interfaces and connectors.
- Control cabinet made of painted steel.

Field of application

- Process water
- Swimming pool water

1 UV Systems Dulcodes

Technical Data

Type	Max. flow m ³ /h	Lamp power W	Connected load kW	Reactor length mm	Minimum clearance for service mm	Empty weight/ Operating weight kg	Connection nominal diameter
1x0,65MP	20.0*	650	0.75	500	335	21/31	DN 65/80
1x1MP	58.0*	1.000	1.10	700	400	31/47	DN 100/125
1x2MP	102.0*	2.000	2.10	700	500	38/65	DN 125/150
1x3MP	205.0*	3.000	3.20	800	600	52/118	DN 200/250
2x2MP	278.0*	4.000	4.20	900	1,000	78/166	DN 200/250
2x3MP	379.0*	6.000	6.20	900	1,000	78/166	DN 250
3x3MP	569.0*	9.000	9.20	900	1,000	78/166	DN 250/300

* 98 %/cm transmission; 600 J/m² UV dose for the breaking down of combined chlorine

Lamp type	Medium-pressure lamp Powerline
Controller type	Comfort controller
Permissible operating pressure	6 bar
Permissible ambient temperature	5 – 40 °C
Permissible water temperature	5 – 40 °C

Medium-pressure lamp Powerline (see p. → 1-2)

Comfort controller (see p. → 1-3)

Spare parts for Dulcodes MP UV systems

	Order no.
Powerline UV lamp 1 kW	1035179
Powerline UV lamp 2 kW	1035057
UV lamp Powerline 3 kW	1035180
Lamp protection tube for Dulcodes 1 A and 0.6 MP	1035218
Lamp protection tube for Dulcodes 1 MP	1035166
Lamp protection tube for Dulcodes 2 MP	1035041
Lamp protection tube for Dulcodes 1 x 3 MP, 2 x 2 MP, 2 x 3 MP, 3 x 3 MP	1035193
Wiper element	1027879
Spare parts kit UV MP 1 – 3 kW motor wiper	1037735
Spare parts kit UV MP 2x2 kW and 2x3 kW motor wiper	1044862
Spare parts kit UV MP 3x3 kW motor wiper	1044863
O-ring lamp protection tube/lamp cover	790410
UVC-U sensor	1080715
Sensor connection cable, 5 m long for systems supplied since September 2006	1021041
Replacement filter mats for control cabinet ventilation (2 off required per control cabinet)	1004212

1 UV Systems Dulcodes

1.8 UV System Dulcodes A

Perfect for the treatment of higher flows.

Flow up to 739 m³/h

The UV system Dulcodes A helps to ensure water quality. The UV system works energy-efficiently and cleanly based on continuously variable medium pressure lamps and can therefore automatically compensate for variations in the water quality or level of contamination.

The UV system Dulcodes A has a compact design. Output-optimised medium pressure lamps ensure effective disinfection of potable water and the photochemical breakdown of oxidants and/or combined chlorine.

The system is fitted with electronic ballasts, which continuously adjust the lamp output, either via an external signal, such as the flow rate, or by specification of a setpoint.

A long-term stable UVC sensor ensures that the system operates safely and reliably. The motor-driven automatic wiper efficiently cleans the lamp protection tubes and minimises maintenance work with types of water that have a tendency to form films. After comprehensive certification and biosimetric validation, the systems comply with strict internationally recognised NSF, UL, CSA and USEPA standards.

Your benefits

- Simple installation, thanks to the compact inline system, ensures minimal installation work and fast retrofitting
- Maximum flexibility when installing, thanks to the free choice of fitting position and direct installation in plastic pipes, as no UV radiation escapes from the reactor
- External power control via 0/4 - 20 mA standard signal for optimum adaptation of the system to changing operating conditions, such as flow fluctuations
- Automatic adjustment of the lamp output to a defined UV-C sensor signal with power increase to a raised, adjustable sensor signal via a digital input saves energy and extends the lamp service life.
- Unbeatable simple and quick maintenance: All maintenance work can be carried out quickly and conveniently from one side.
- Certified systems: NSF 50, CSA 22, UL508, comprehensively biosimetrically validated to UVDGM 2006

Technical Details

- Optimised use of energy, thanks to large radiation chamber and uniform irradiation of the entire water flow due to optimised system hydraulics.
- Radiation chambers made of high-grade stainless steel 1.4404/AISI316L
- Powerline A medium-pressure lamps with high power input of up to 3 kW
- Guaranteed (pro rata) lamp service life of 8,000 hours
- Long-term stable UVC sensor for monitoring the lamp output, lamp protection tube fouling and changes in water quality
- Integral temperature sensor for monitoring the water temperature in the radiation chamber
- Automatic motor-driven wiper for efficient removal of deposits on the lamp protection tube
- Double, independent and automatic monitoring of the wiper function by revolution counter and limit switch
- Control cabinet made of coated steel
- Freely programmable control (Comfort controller Dulcodes A) with backlit display during normal operation (green), warning (yellow) and fault (red)
- Large graphic display to show all important operating parameters, such as the UV sensor signal, lamp power consumption, control type and operating status
- Interfaces and connectors for:
 - Stopcock and flushing valve
 - Control of the feed pump
 - Operating signal relay
 - Warning and alarm relay for UV intensity
 - Collective malfunction alert relay
 - Pause contact
 - Relay for monitoring reactor temperature
 - Temperature monitoring and fault indicating relay for control cabinet temperature
 - Input for external fault
 - Digital input for switch-over to second power stage
 - 4-20 mA standard signal input for flow-dependent lamp control or control dependent on measured value
 - Standard signal output 4-20 mA of UV sensor signal

NSF 50
UVDGM 2006
UL-CSA

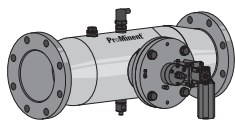

P_PMA_DS_0033_SW

1 UV Systems Dulcodes

Field of application

- Potable water
- Process water
- Swimming pool water

Technical Data

Type	Max. flow m ³ /h	Lamp power W	Connected load kW	Reactor length mm	Minimum clearance for service mm	Min. distance from wall mm	Empty weight/ Operating weight kg	Connection nominal diameter
1 x 1A	66.0* / 76.0**	1.000	1.10	700	400	300	31/47	DN 100/4"
1 x 2A	116.0* / 133.0**	2.000	2.10	700	500	300	38/65	DN 150/6"
1 x 3A	232.0* / 266.0**	3.000	3.20	800	600	300	52/118	DN 200/8"
2 x 2A	309.0* / 362.0**	4.000	4.20	900	1,000	300	78/166	DN 200/8"
2 x 3A	464.0* / 493.0**	6.000	6.20	900	1,000	300	78/166	DN 250/10"
3 x 3A	696.0* / 739.0**	9.000	9.20	900	1,000	300	78/166	DN 300/12"

* 98 %/cm transmission; 600 J/m² UV dose for the breaking down of combined chlorine

** 98 %/cm transmission; 400 J/m² UV dose for disinfection applications

Lamp type	Medium-pressure lamp Powerline A
Permissible operating pressure	10 bar (for systems 1 x 1A - 1 x 3A) 7 bar (for systems 2 x 2A - 3 x 3A)
Permissible ambient temperature	5 – 40 °C
Permissible water temperature	5 – 40 °C

Medium-pressure lamp Powerline A (see page → 1-2)

Spare Parts for Dulcodes A UV Systems

	Order no.
Powerline UV lamp 1 kW	1035179
Powerline UV lamp 2 kW	1041450
Powerline UV lamp 3 kW	1041451
Lamp protection tube for Dulcodes 1 A and 0.6 MP	1035218
Lamp protection tube for Dulcodes 2 A	1041723
Lamp protection tube for Dulcodes 3 A	1041485
Wiper element	1027879
Spare parts set for UV A 1-3 kW motor wiper	1042860
Spare parts kit UV MP 2x2 kW and 2x3 kW motor wiper	1044862
Spare parts kit UV MP 3x3 kW motor wiper	1044863
O-ring lamp protection tube	1023569
UVC-U sensor M -1, 4-20 mA	1080714
Replacement filter mats for control cabinet ventilation (2 off required per control cabinet)	1004212

1 UV Systems Dulcodes

1.9 Accessories for Dulcodes UV Systems

Remote monitoring module DULConnect



P_AC_0274_SW

Module for connection to the CAN interface of the UVCb control for remote monitoring and remote control of the Dulcodes systems. The DULConnect module can communicate with many smart devices (smartphone, tablet) or desktop computer (PC, laptop) via WLAN or LAN. The data is provided via a web server of the DULConnect and displayed on the terminal unit using any common browser. Supply including connecting cable for wall installation beside the UV system. CAN connecting cables with a length of up to 20 m enable the module to be installed at a remote distance from the UV system. The DULConnect module is ordered by the corresponding selection of the identity code characteristic.

Available connection cable

	Order no.
Connecting cable LAN M12 - RJ45 5.0 m	1026715

1/2" drain kit for Dulcodes LP systems

2 no. 1/2" stainless steel ball valves and connecting material for direct connection to the reactor for drainage and bleeding.

	Order no.
1/2" drain kit for Dulcodes 2 x 350LP to 6 x 350LP	1075776

Transmission Photometer UVT P200

Photometer for measuring 254 nm UV transmission.

Supplied in stable, compact, water-tight plastic box including 10 mm quartz cuvette. Storage of the in-situ calibration means that a calibration using deionised water prior to every calibration is not necessary.

Technical Data

Dimensions L x W x H (mm)	230 x 190 x 95
Weight	1.8 kg
Voltage supply	100 - 240 V AC 50/60 Hz, 12 V DC auto-adaptor
UV-C lamp	Mercury medium pressure lamp
Measuring resolution	Transmission in 0.1%
Measuring accuracy	Transmission in ± 0.5%
Measuring range	5 – 100%/cm

	Order no.
Transmission Photometer UVT P200	1045245

1 UV Systems Dulcodes

Reference Radiometer RRM

Reference radiometer for checking certified UV systems Dulcodes LP. The portable instrument is fitted with an insertion sensor which is used for measurement of the radiation intensity without operational interruption directly in the radiation chamber of the Dulcodes LP in place of the unit sensor. Suitable UV protective glasses should be worn as UV radiation escapes from the radiation chamber during this procedure.

Technical Data

Measuring range	20/200/2,000/20,000 W/m ² (switchable)
Display	3-digit
Voltage supply	Battery, 9 V Type 6F22 or equivalent

		Order no.
Reference radiometer RRM	for measuring field angle 40°	1025094
Reference radiometer RRM	for measuring field angle 160°	1076575
Reference radiometer RRM	for measuring field angle 40° and 160°	1076576

UV Protective Glasses

Protective glasses to protect against UV radiation that can be harmful to the eyes when working on open UV systems.

	Order no.
UV protective glasses	1025243

Protective Gloves

Protective gloves made of white cotton to avoid fingerprints on UV lamps and lamp sleeves. 1 pair universal size.

	Order no.
Protective gloves	1032815

Sampling Cock

Fireproof sampling cock made of stainless steel.

	Order no.
Sampling cock	On request

Cleaning System

Cleaning system for flushing the radiation chamber with a cleaning solution to remove deposits on the lamp tubes and internal surfaces of the UV system. Consists of chemical tanks, booster and metering pumps, valves and complete automatic or manual controller. Design and technical equipment are matched to the particular UV system and its application.

	Order no.
Cleaning system	On request

1 UV Systems Dulcodes

Fittings

Fittings provided for quick and easy wall mounting of the UV radiation chamber. Fitting parts comprise 2 screw-in pipe clips in high alloy steel (V2A), 2 base plates with M12 nut, 2 set screws and 4 M12 hexagon nuts.

Two-part clip with increased material cross-section to ensure high bearing strength and breaking resistance. A soundproofing layer ensures marked resistance in the sound level.

	Type	Order no.
Fittings A2	1x80LP, 1x230LP	1039828
	1x350LP, 3x230LP	1077823
	2x350LP	1077844

Overvoltage Protection

Overvoltage protection for Dulcodes UV systems operated at 230 V 50-60 Hz.

The external overvoltage protection is intended for operations when the device's internal protection is not sufficient for surge voltages of 1 kV between the conductors and 2 kV to earth. An overvoltage trip can be fitted as a low protection surge arrester to significantly increase the stability of the Dulcodes systems to protect them when the supply mains is prone to disturbance energy.

It can only be determined by thorough investigation of the voltage behaviour on site whether the low protection surge arrester requires further measures, such as medium and main protection.

	Order no.
Fine protection PT 2-DE IS 230 IAC	733010

Replacement Plug-in Insert After Tripping

	Order no.
Replacement plug-in insert PT 2-DE / S 230 / AC - ST	733011

Clip-on thermostat for systems with compact control

	Order no.
Clip-on thermostat 30-90 °C 230 VAC	104394

2 Ozone Systems OZONFILT®

2.1 Ozone In Water Treatment

As the most powerful oxidant that can be used in water treatment, ozone permits a broad spectrum of possible applications:

Outstanding disinfection action against

- Bacteria and viruses
- Fungi and parasites

Oxidation of undesirable inorganic substances in the water

- Iron and manganese
- Arsenic
- Nitrite and sulphide

Oxidation of undesirable organic substances in the water

- Strong-smelling and strong-tasting compounds
- Humic substances and other compounds which affect the colour of the water
- Cyclic hydrocarbons
- Trihalomethanes, chloramines and other chlorine compounds

Micro-flocculating properties

- After oxidation with ozone, substances and colloids dissolved in the water become insoluble and can be filtered

Significantly less environmentally harmful by-products result from the generation and use of ozone than other comparable oxidants and disinfectants. As a highly reactive gas, ozone is generated on site from oxygen, and introduced to the water directly, without interim storage. Because of its high reactivity, ozone decomposes into oxygen again in the water, with a half-life of several minutes. Therefore all components of an ozone handling system have to be perfectly coordinated to each other and the planned application, to achieve an optimum relationship between ozone generation and its effect.

With every new project, our engineers draw on experience that we have accumulated since 1971 in the following applications:

Potable water supply

- Oxidation of iron, manganese or arsenic
- Refinement and improvement of taste
- Disinfection

Food and beverage industry

- Disinfection of table water
- Disinfection of rinsers in the beverage industry
- Disinfection of process water

Swimming pools

- Reduction of chloramines and trihalomethanes, avoiding typical swimming pool odours
- Crystal clear water, thanks to micro-flocculating action
- Reliable microbiological barriers in therapy pools
- Reduction of investment and operating costs by the possibility of reducing the circulating power and throttling the fresh water inlet

Industry

- Cooling water treatment
- Combating legionella in cooling water circuits
- Disinfection of process water
- Removal of odorous substances in air scrubbers

Municipal waste water treatment

- Breakdown of trace substances
- Reduction of clarifier sludge
- COD reduction/breakdown
- Removal of colouring

2 Ozone Systems OZONFILT®

2.2 Performance Overview of Ozone Systems

ProMinent® ozone systems operate based on the proven principle of silent electrical discharge. Ozone is produced from oxygen between two electrodes separated by an insulating dielectric by applying a high voltage of several thousands of volts. Depending on the system type, either dried ambient air or concentrated oxygen is used as the source of oxygen. ProMinent® ozone systems are optimised to ensure maximum return and operating safety. They conform to the German DIN 19627 standard for ozone generation systems and are characterised by low energy and cooling water consumption.

Medium-frequency pressure systems

With the OZONFILT® OZVa and OZMa product range, the air or oxygen operating gas is fed to the ozone generator under pressure. Ozone is generated using medium-frequency high voltages.

The use of an integrated pressure swing dryer and a dielectric with optimum thermal conductivity makes the system extremely compact.

Operating under pressure means that the ozone generated can be introduced directly into water systems with back pressures of up to 2 bar. Additional booster pumps and injectors can therefore be dispensed with in many applications.

ProMinent offers a wide range of ozone systems for the most diverse applications. The overview below shows the capacity ranges of our type series:

Output [g ozone/h]	OZVa 1-4	OZVa 5-7	OZMa 1-6 A	OZMa 1-6 O
1.000				
500				
200				
100				
50				
20				
10				
5				
2				
Operating gas	Air	Oxygen	Air	Oxygen
Ozone concentration	20 g/Nm ³	100 g/Nm ³	20 g/Nm ³	100 g/Nm ³

P_PMA_OF_0011

Larger systems available on request

ProMinent provides all the advice needed for the safe operation of an ozone plant:

- Evaluation of the situation on site by trained, expert field sales staff.
- In our water laboratory, we can measure all the key water parameters required for optimum plant design.
- Planning of the plant.
- Commissioning and plant service by our trained service technicians.

2 Ozone Systems OZONFILT®

2.3 Questionnaire on the Design of an Ozone System

Use of the ozone system:

- for treatment of
 - Drinking water
 - Product water in the food and beverages industry, cosmetics or pharmaceutical industry
 - Industrial water
 - Cooling water
 - Swimming pool water
 - Zoo
 - _____
- for oxidation of
 - Iron, manganese, nitrite, sulphide etc.
 - Organic matter
 - Discolouration
 - _____
- _____

Water values:

- | | | | |
|----------------------|-----------------------------------|---|--|
| Max. water flow rate | _____ m ³ /h | Maximum water pressure | _____ bar |
| Water flow rate | <input type="checkbox"/> constant | <input type="checkbox"/> fluctuating from | _____ m ³ /h to _____ m ³ /h |
| pH value | _____ | Iron (Fe ²⁺) | _____ mg/l |
| Temperature | _____ °C | Manganese (Mn ²⁺) | _____ mg/l |
| Solid fraction | _____ mg/l | Nitrite (NO ₂ ⁻) | _____ mg/l |
| | | Sulphide (S ²⁻) | _____ mg/l |
| | | TOC (total organic carbon) | _____ mg/l |

Response time to application:

_____ m³ volume reaction tank or _____ minutes residence time in entire system.

Type of metering:

- constant
- flow-proportional
- depending on measured value

Desired amount of metering: _____ mg/l

Other requirements:

2 Ozone Systems OZONFILT®

2.4 Ozone System OZONFILT® OZVa

Generate ozone from compressed air or oxygen. Environmentally-friendly and cost-effective.

Ozone capacity 5 – 90 g ozone/h



The OZONFILT® OZVa is high-performance and compact. For efficient ozone generation in the medium output range of up to 90 g/h from compressed air or oxygen.

Ozone systems OZONFILT® OZVa are pressurised systems in which the operating gas – air or oxygen – is fed into the ozone generator under pressure.

Air is used as the operating gas in the ozone system OZONFILT® OZVa type 1 to 4

The ozone is generated from the oxygen in the ambient air and simultaneously metered. The integrated air treatment unit is designed as a pressure swing dryer, ensuring that ozone can be generated operationally safely and reliably even with a high level of ambient air humidity with ozone concentrations of up to 20 g/Nm³. Using the suitable mixing equipment, ozone concentrations of between 3 and 12 ppm can be achieved in the water to be treated, depending on the temperature.

Oxygen is used as the operating gas in the ozone system OZONFILT® OZVa type 5 to 7

Oxygen operation permits ozone generation with ozone concentrations of up to 150 g/Nm³. Depending on the system type, ozone is produced in 1-3 generators from oxygen provided from special oxygen generators or bottles. Using the suitable mixing equipment, ozone concentrations of up to 90 ppm can be achieved in the water to be treated, depending on the temperature.

Your benefits

- Simple operation
- Ozone generation independent of pressure and mains voltage
- Direct injection without injector system at up to 2 bar back pressure
- Maximum efficiency with minimal consumption of energy and cooling water
- Complete protection of electrical components (high-voltage transformer and power stage) thanks to PCC technology (primary current-controlled)
- Low maintenance and operating costs
- Infinitely precise output control of between 3% and 100% of the nominal power with display of the ozone volume in "grammes/hour"

Technical Details

- Compact mounting in painted steel cabinet or optionally in a stainless steel cabinet
- Wall cabinet for OZVa 1, 2 and 5; free-standing cabinet for OZVa 3, 4, 6 and 7
- Special dielectric with outstanding cooling performance: in spite of the low cooling water consumption, heat is quickly and efficiently discharged before the ozone produced can decompose due to excessive heat
- Different designs up to complete equipment including integral mixing unit
- Excellent efficiency: Over 90% of the ozone is dissolved in the water, thanks to the special construction of the mixing unit
- Pause input for external switching on/off
- Analogue input 4-20 mA for power control depending on the measured value combined with external measuring and control technology
- Digital inputs for connection of a gas detector or external fault alarm
- Digital alarm signal output
- Air conditioning: With ambient temperature above 40 °C, the system can be equipped with an integral air conditioner. Max. ambient temperature with air conditioning: 50 °C

Field of application

- **Potable water supply:** Oxidation of iron, manganese and arsenic, refinement and taste enhancement and disinfection
- **Waste water treatment:** Degradation/reduction of COD and microcontaminants, reduction of sewage sludge
- **Food and beverage industry:** Oxidation of iron and manganese, disinfection of potable water and rinser water
- **Public swimming pools:** Degradation of disinfection by-products, reliable microbiological barrier and production of crystal-clear water thanks to its microfloculating effect
- **Industry:** Legionella prevention and disinfection of cooling water

2 Ozone Systems OZONFILT®

2.4.1

OZONFILT® OZVa 1-4 Ozone Generation Systems (Process Gas - Air)

Under nominal conditions, the series OZVa 1 – 4 produces up to 40 g/h of ozone from oxygen in the ambient air at a concentration of 20 g/Nm³. Using the designated mixing devices, ozone concentrations of between 3 and 12 ppm can be achieved in the water to be treated, depending on the temperature (theoretical value at 30 and/or 0 °C).

Types OZVa 1 and 2 are installed in a control cabinet for wall mounting; types OZVa 3 and 4 are installed in a free-standing cabinet.

Provide an adequate supply of compressed air and a mixing unit designed for the operating conditions for operation of the ozone system.

Mixing equipment

OZVa 1 can be ordered in the following designs:

- Transparent mixing system with flow control mounted on the side of the system (see Fig. pk_7_001_1_V2)
- PVC static helical mixer mounted directly below the system, with 4 helical blades (pressure drop approx. 0.4 bar at maximum throughput) (see Fig. pk_7_042_V2)
- Without mixing system for connection of 12/10 mm stainless steel pipes or 12/9 mm PTFE pipes

OZVa 2 can be ordered in the following designs:

- PVC static helical mixer mounted directly below the system, with 4 helical blades (pressure drop approx. 0.4 bar at maximum throughput) (see Fig. pk_7_042_V2)
- Without mixing system for connection of 12/10 mm stainless steel pipes or 12/9 mm PTFE pipes

OZVa 3 and 4 are delivered, in principle, as designs without mixing system; order a suitable mixing system separately (see Fig. pk_07_043_V2).

Static Helical Mixer Made of PVC or Stainless Steel see p. → 2-24

Notes

- The length of ozone gas-transporting pipes and the number of joints should be kept to a minimum. All rooms with a removable joint are to be monitored with a gas detector according to applicable German accident prevention regulations. All OZONFILT® systems are equipped for fitting Ozone detector.
- The ozone generator must be interlocked with the water flow into the metering point on all installations.
- A non-return valve should be installed upstream of the OZVa to prevent any return of ozonised water into the ozone-transporting pipe.

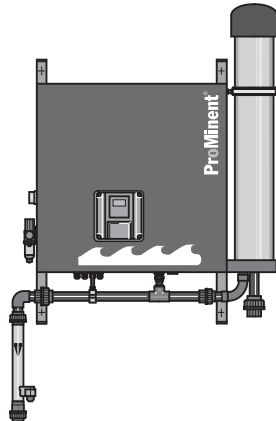

P_PMA_OF_0001_SW
OZONFILT® OZVa 1; capacity: 5 g/h

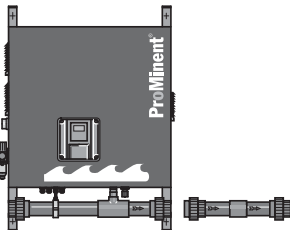

P_PMA_OF_0002_SW
OZONFILT® OZVa 2; capacity: 15 g/h

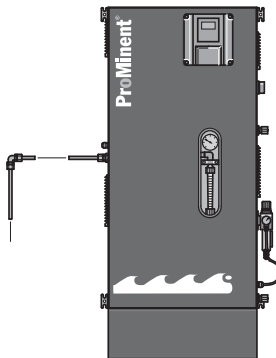

P_PMA_OF_0003_SW
OZONFILT® OZVa 3; capacity: 35 g/h

2 Ozone Systems OZONFILT®

Technical Data

OZONFILT® OZVa 1-4 ozone production systems (operating gas - air)

Ambient parameters

Max. 85% air humidity of the ambient air, non-condensing, non-corrosive, dust-free, max. ambient temperature: 40 °C
(with integrated air conditioning system: 50 °C)

		OZVa 1	OZVa 2	OZVa 3	OZVa 4
Number of generator modules		1	1	2	2
Ozone capacity, measured in accordance with DIN with air at 20 °C, cooling water at 15 °C	g/h	5	15	35	40
Air consumption (only ozone generation)	Nm ³ /h	0.25	0.75	1.75	2
Ozone concentration in the gas phase referenced to nominal conditions	g/Nm ³ *	20	20	20	20
Specific energy requirement at nominal capacity	Wh/g	30	30	21	20
Power factor at full capacity	cos φ	0.70	0.98	0.98	0.98
Ozone connection		G 1/4" female	G 1/4" female	G 1/4" female	G 1/4" female

* Nm³ = m³ under standard conditions (p = 1.013x10⁵ Pa, T = 273 K)

Electrical Connection

		OZVa 1	OZVa 2	OZVa 3	OZVa 4
Connected load	V/Hz/A	230/50;60/2	230/50;60/6	230/50;60/6	230/50;60/6
Enclosure rating		IP 54	IP 54	IP 54	IP 54
Degree of protection with integrated air conditioning unit (internal/external)		IP 54 / IP 34	IP 54 / IP 34	IP 54 / IP 34	IP 54 / IP 34

Overall Dimensions (Without Mixer)

		OZVa 1	OZVa 2	OZVa 3	OZVa 4
Width	mm	840	840	710	710
Height	mm	840	805	1,400	1,400
Depth	mm	310	310	310	310

Weight

		OZVa 1	OZVa 2	OZVa 3	OZVa 4
Weight	kg	70	75	121	121

Ozone Mixing

		OZVa 1	OZVa 2	OZVa 3	OZVa 4
Max. raw water temperature	°C	35	35	35	35
Permissible pressure at ozone outlet	bar	0.8–2.0	0.8–2.0	0.8–2.0	0.8–1.5

Air Supply

		OZVa 1	OZVa 2	OZVa 3	OZVa 4
Air demand	NI/min	6.2	17	38	42

Air quality oil and dust-free, non-corrosive, constant priming pressure of 6 – 10 bar, max. temperature 40 °C

Cooling Water

		OZVa 1	OZVa 2	OZVa 3	OZVa 4
Cooling water requirement	l/h	10–60	20–60	50–100	70–100
Cooling water inlet pressure	bar	1–5	1–5	1–5	1–5
Cooling water inlet, PE pressure hose	mm	6 x 4	6 x 4	6 x 4	6 x 4
Cooling water outlet, open discharge	mm	6 x 4	6 x 4	6 x 4	6 x 4
Cooling water temperature at ambient temp. max. 35 °C	°C	<30	<30	<30	<30
Cooling water temperature at ambient temp. 35–40 °C	°C	<25	<25	<25	<25

Cooling water quality No tendency to form lime scale, no corrosive components, removable substances: < 0.1 ml/l, iron: < 0.2 mg/l, manganese: < 0.05 mg/l, conductivity: > 100 µS/cm, chloride: < 250 mg/l

2 Ozone Systems OZONFILT®

2.4.2

OZONFILT® OZVa 5-7 Ozone Production Systems (Operating Gas - Oxygen)

The product range OZONFILT® OZVa 5 – 7 is a new development based on proven PSG technology, which produces ozone concentrations of up to 150 g/Nm³ using oxygen as the operating gas. Using the designated mixing units, ozone concentrations of up to 90 ppm can be achieved (theoretical value at 0 °C) in the water to be treated.

Depending on the system type, ozone is produced in 1 – 3 generators from oxygen, provided from special oxygen generators or bottles. The nominal capacity of the individual generators is 30 g/h at 100 g/Nm³.

Type 5 is installed in a wall-mounted cabinet, types 6 and 7 are installed in a free-standing cabinet. In all three systems, ozone is transported to the mixing unit through a separate 12/10 mm stainless steel pipe or 12/9 mm PTFE pipe.

Mixing equipment

We recommend using stainless steel mixing systems because of the high ozone concentrations. Mixing systems made of PVC can have a reduced service life, depending on the operating conditions.

Important note

- Keep the length of pipes for conveying ozone and the number of joints to a minimum. Monitor all adjoining rooms with a gas detector, in line with the applicable German accident prevention regulations. All OZONFILT® systems are equipped for the fitting of a gas detector, such as type GMA 36 Ozone.
- Depending on the operating and installation conditions, it might also be necessary to monitor the room air for excessive oxygen content.
- It is necessary for the ozone generation system to be interlocked with the water flow to the ozone metering on all installations.
- Install a non-return valve upstream of the OZVa to prevent any backflow of ozonised water into the pipe transporting the ozone.
- Ensure that all accessories that transport gas are resistant to ozone and oxygen (e.g. grease-free).
- Only use catalytic residual ozone destructors because of the high ozone concentrations. Activated charcoal based residual ozone destructors ignite spontaneously if subjected to increased ozone concentrations.

Room Air Monitoring see p. → 2-26

2 Ozone Systems OZONFILT®

Technical Data

OZONFILT® OZVa 5-7 ozone production systems (Operating Gas - Oxygen)

Ambient parameters

Max. 85% air humidity of the ambient air, non-condensing, non-corrosive, dust-free, max. ambient temperature: 40 °C
(with integrated air conditioning system: 50 °C)

		OZVa 5	OZVa 6	OZVa 7
Number of generator modules		1	2	3
Nominal ozone capacity at 100 g/Nm³ ** and cooling water at 15 °C	g/h	30	60	90
Ozone capacity at 150 g/Nm³ *	g/h	17.5	35.0	52.0
Ozone capacity at 80 g/Nm³	g/h	35	70	105
Specific energy requirement at nominal capacity	Wh/g	10	10	10
Power factor at full capacity	cos φ	0.98	0.98	0.98
Ozone connection		G 1/4" female	G 1/4" female	G 1/4" female

Electrical Connection

		OZVa 5	OZVa 6	OZVa 7
Connected load	V/Hz/A	230/50;60/3	230/50;60/6	230/50;60/10
Enclosure rating		IP 54	IP 54	IP 54
Degree of protection with integrated air conditioning unit (internal/external)		IP 54 / IP 34	IP 54 / IP 34	IP 54 / IP 34

Overall Dimensions (Without Mixer)

		OZVa 5	OZVa 6	OZVa 7
Width	mm	865	705	705
Height	mm	804	1,400	1,400
Depth	mm	310	345	345

Weight

		OZVa 5	OZVa 6	OZVa 7
Weight	kg	75	109	114

Ozone Mixing

		OZVa 5	OZVa 6	OZVa 7
Max. raw water temperature	°C	35	35	35
Permissible pressure at ozone outlet	bar	0.8–2.0	0.8–2.0	0.8–2.0

Specification of Operating Gas: Oxygen

		OZVa 5	OZVa 6	OZVa 7
Gas volume at nominal capacity 100 g/Nm³	Nl/h	300	600	900
Gas volume at capacity 150 g/Nm³	Nl/h	117*	234*	347*
Gas volume at capacity 80 g/Nm³	Nl/h	438	875	1,313
Concentration min.	vol%	90	90	90
Dew point max.	°C	-50	-50	-50
Pressure	bar	3–6	3–6	3–6
Max. particles	µm	5	5	5
Max. hydrocarbons	ppm	20	20	20
Max. temperature	°C	30	30	30

Cooling Water

		OZVa 5	OZVa 6	OZVa 7
Cooling water requirement	l/h	30	70	100
Cooling water inlet pressure	bar	1–5	1–5	1–5
Cooling water inlet, PE pressure hose	mm	6 x 4	6 x 4	6 x 4
Cooling water outlet, open discharge	mm	6 x 4	6 x 4	6 x 4
Cooling water temperature at ambient temp. max. 35 °C	°C	<30	<30	<30
Cooling water temperature at ambient temp. 35–40 °C	°C	<25	<25	<25

Cooling water quality

No tendency to form lime scale, no corrosive components, removable substances: < 0.1 ml/l, iron: < 0.2 mg/l, manganese: < 0.05 mg/l, conductivity: > 100 µS/cm, chloride: < 250 mg/l

* Capacity 150 g/Nm³ must be factory set as a special version

** Nm³ = m³ under standard conditions (p = 1.013x10⁵ Pa, T = 273 K)

2 Ozone Systems OZONFILT®

Ordering Information for OZONFILT® OZVa Systems

OZONFILT® OZVa 1 Capacity 5 g/h

Type	Control cabinet surface	Order no.
Without mixing system	Grey powder-coated	1004239
Without mixing system	Stainless steel	1026124
With transparent mixing system with flow monitor 0.5–3 m³/h	Grey powder-coated	1026118
With transparent mixing system with flow monitor 0.5–3 m³/h	Stainless steel	1026125
With transparent mixing system with flow monitor, 3–5 m³/h	Grey powder-coated	1004235
With transparent mixing system with flow monitor, 3–5 m³/h	Stainless steel	1026126
With PVC static mixer, DN 40, 5–10 m³/h	Grey powder-coated	1026120
With PVC static mixer, DN 40, 5–10 m³/h	Stainless steel	1026127
With PVC static mixer, DN 50, 10–15 m³/h	Grey powder-coated	1026121
With PVC static mixer, DN 50, 10–15 m³/h	Stainless steel	1026128
With PVC static mixer, DN 32, 0.5–2.8 m³/h	Grey powder-coated	1026122
With PVC static mixer, DN 32, 0.5–2.8 m³/h	Stainless steel	1026129
With PVC static mixer, DN 32, 2.8–5 m³/h	Grey powder-coated	1026123
With PVC static mixer, DN 32, 2.8–5 m³/h	Stainless steel	1026130

OZONFILT® OZVa 2 Capacity 15 g/h

Type	Control cabinet surface	Order no.
Without mixing system	Grey powder-coated	1005129
Without mixing system	Stainless steel	1026133
With PVC static mixer, DN 40, 5–10 m³/h	Grey powder-coated	1005127
With PVC static mixer, DN 40, 5–10 m³/h	Stainless steel	1026134
With PVC static mixer, DN 50, 10–15 m³/h	Grey powder-coated	1005806
With PVC static mixer, DN 50, 10–15 m³/h	Stainless steel	1026135
With PVC static mixer, DN 32, 0.5–2.8 m³/h	Grey powder-coated	1026132
With PVC static mixer, DN 32, 0.5–2.8 m³/h	Stainless steel	1026144
With PVC static mixer, DN 32, 2.8–5 m³/h	Grey powder-coated	1005125
With PVC static mixer, DN 32, 2.8–5 m³/h	Stainless steel	1026145

OZONFILT® OZVa 3 Capacity 35 g/h

Type	Control cabinet surface	Order no.
Without mixing system	Grey powder-coated	1009083
Without mixing system	Stainless steel	1026146

OZONFILT® OZVa 4 Capacity 40 g/h

Type	Control cabinet surface	Order no.
Without mixing system	Grey powder-coated	1009105
Without mixing system	Stainless steel	1026147
without mixing system with air conditioning unit	Stainless steel	1049716

OZONFILT® OZVa 5 Capacity 30 g/h Operating Gas Oxygen

Type	Control cabinet surface	Order no.
Without mixing system	Grey powder-coated	1026148
Without mixing system	Stainless steel	1026149
without mixing system with air conditioning unit	Stainless steel	1049717

2 Ozone Systems OZONFILT®

OZONFILT® OZVa 6 Capacity 60 g/h Operating Gas Oxygen

Type	Control cabinet surface	Order no.
Without mixing system	Grey powder-coated	1023452
Without mixing system	Stainless steel	1026150
without mixing system with air conditioning unit	Stainless steel	1049718

OZONFILT® OZVa 7 Capacity 90 g/h Operating Gas Oxygen

Type	Control cabinet surface	Order no.
Without mixing system	Grey powder-coated	1026151
Without mixing system	Stainless steel	1026152

2 Ozone Systems OZONFILT®

2.4.3

System Solution OZONFILT® Compact OMVa

Individually adaptable thanks to modular construction

Ozone capacity 5 – 70 g ozone/h



The OZONFILT® Compact OMVa is a complete, ready-to-use ozone system solution for the generation and metering of ozone. The components are perfectly coordinated to each other.

The ozone system OZONFILT® Compact OMVa has a modular construction mounted on a stainless steel frame. It can therefore be simply adapted to and integrated in the respective application.

A sufficient quantity and constant concentration of ozonised water is produced in the system's reaction tank. From there it is pumped to where it is needed. The required ozone concentration can be adjusted and is continuously controlled and held constant by a measuring and control circuit. Depending on the application, the ozonised water is pumped by system pressure or with one or more discharge pumps to where it is needed.

With the removal and replenishment of water in the storage tank, the air, which contains ozone, is discharged out via the water phase and via a residual ozone gas destructor. Ensure that no ozone escapes into the ambient air in normal operation.

Your benefits

- Excellent process reliability through the use of a pre-assembled, complete ozone treatment stage with perfectly coordinated components.
- Well-thought-out installation on a stainless steel frame for plug-and-play connection
- Modular construction which can still be customised
- Compression-proof ozone generator built in compliance with DIN 19627
- Destruction of residual ozone gas for the removal of traces of ozone gas
- Room air monitoring for traces of ozone gas via a gas detector with a sensor with long-term stability
- Metering ozone, depending on the measured values, ensures a constant ozone concentration in the reaction tank
- A central electric control ensures metering of ozone depending on the measured values and the control of all connected peripheral components.
- Clear and simple operation, as well as signal exchange with higher-order control systems

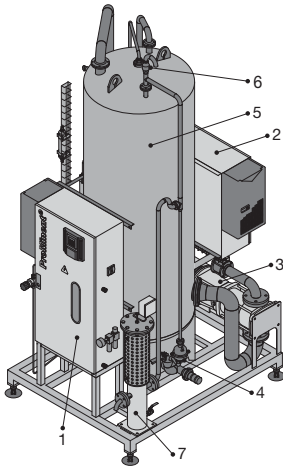

P_PMA_OF_0073_SW1

- 1 Ozone generation
- 2 Central control unit
- 3 Discharge system
- 4 Water separator
- 5 Reaction tank
- 6 Bleed valve
- 7 Residual ozone gas destructor

Technical Details

Modules:

- Central control unit
- Ozone generation
- Reaction tank
- Discharge system
- Ozone mixing unit
- Residual ozone gas destruction
- Room air monitoring

Available options:

- 1 or 2 discharge pumps for pumping of ozonised water to where it is used
- Cooling water chiller for supply of chilled water to the ozone system
- Air conditioning unit for air conditioning of the ozone system and central control cabinet
- Storage tank cleaning with built-in atomizer including valve combination

Ozone generation module, built in accordance with DIN 19627:

The ozone is produced with an OZONFILT® OZVa or OZMa in a pressure-resistant ozone generator using an electronically produced and regulated medium frequency.

Central control unit module

A central control unit manages the entire process and ensures ozone metering dependent on the measured value. A panel visualises the entire process, thereby simplifying operation. A high-quality control for industrial applications (Siemens S7-300 with TP 177 B) permits varied signal exchange with higher-level management systems.

Discharge system module

As soon as the ozone concentration setpoint has been reached, the ozonised water is pumped on-demand to where it is needed. This is done by the pump or a discharge system with one or more discharge pumps.

2 Ozone Systems OZONFILT®

Ozone mixing module:

This module comprises an ozone metering point and a downstream mixing section made of stainless steel, with a series of static mixing elements for intensive mixing of the ozone/air mix with the water to be treated. The lines carrying the ozone, and the pipework from the raw water connection to the inlet to the reaction tank are made throughout in stainless steel and have been factory-pressure tested.

An injector for sucking out the ozone is not needed with back pressures of up to 1.8 bar because the ozone is generated at positive pressure.

Reaction tank module:

The stainless steel reaction tank incorporates all the necessary fittings for water distribution and an automatic bleed valve. The ozone generation module, residual ozone gas destructor module and room air monitoring module are mounted on this storage tank.

Residual ozone gas destruction module:

The residual ozone gas destruction module has an integrated water separator to remove any traces of ozone gas in the exhaust air coming from the reaction tank.

Room air monitoring module:

The room air is monitored for traces of ozone gas using a calibrated gas detector with a long-term stable electrochemical sensor.

If the alarm threshold is exceeded, ozone generation is stopped and an alarm signalled. A buzzer is activated at the same time.

Field of application

- **Food and beverage industry:** Oxidation of iron and manganese, disinfection of potable water and rinsing water
- **Swimming pools:** Degradation of disinfection by-products, reliable microbiological barrier and production of crystal-clear water thanks to its microfloculating effect

Technical Data

Type		OMVa 5 – 200	OMVa 15 – 500	OMVa 35-1,000	OMVa 40-1,000	OMVa 70-2,000
Type: ozone generation system		OZVa 1	OZVa 2	OZVa 3	OZVa 4	OZMa 1A
Ozone output at 20 g/Nm ³	g/h	5	15	35	40	70
Cooling water volume (15 °C)	l/h	10–60	20–60	50–100	70–100	90
Nominal flow rate	m ³ /h	1.5 – 5	5 – 15	15 – 30	30 – 45	45 – 60
Enclosure rating		IP 54	IP 54	IP 54	IP 54	IP 54
Connected load	V/Hz/A	230/50;60	230/50;60	230/50;60	230/50;60	230/50;60

2 Ozone Systems OZONFILT®

2.5

Ozone System OZONFILT® OZMa

Powerful and yet environmentally-friendly. Disinfect and oxidise ecologically and economically.

Ozone capacity 70 – 735 g ozone/h



OZONFILT® OZMa represents maximum operational safety with minimal operating costs. The ozone generator is maintenance-free and generates up to 735 g/h of ozone from compressed air or oxygen.

The ozone systems OZONFILT® OZMa have been designed as pressurised systems, in which the operating gas – air or oxygen – is fed into the ozone generator under pressure.

Air is used as the operating gas in the ozone system Ozonfilt® OZMaA types 1 to 6

The ozone is generated from the oxygen in the ambient air and simultaneously metered. A demand-led, self-optimising pressure swing dryer reduces the consumption of compressed air to a minimum. Ozone can therefore be generated operationally safely and reliably even with a high level of ambient air humidity with ozone concentrations of up to 20 g/Nm³. Ozone concentrations of between 3 and 12 ppm can be achieved in the water to be treated with suitable mixing units, depending on the temperature.

Oxygen is used as the operating gas in the ozone system Ozonfilt® OZMaO type 1 to 6

Operation with oxygen permits ozone generation with ozone concentrations of up to 150 g/Nm³. Depending on the system type, ozone is produced in 1-3 generators from oxygen provided from special oxygen generators or bottles. Using the suitable mixing equipment, ozone concentrations of up to 90 ppm can be achieved in the water to be treated, depending on the temperature.

Your benefits

- Economical: maintenance-free generator concept with virtually unlimited service life
- Up to 30% energy savings for air treatment, thanks to demand-led and self-optimising air drying compared with conventional air treatment.
- Automatic control of the operating gas depending on the ozone output, therefore reduced consumption of operating gas produced with intensive use of energy.
- High ozone concentration ensures optimum ozone solubility in water
- Direct injection without injector system at up to 2 bar back pressure
- Automatic ozone generation, virtually independent of fluctuations in main voltage and pressure
- Simple, safe and reliable operation and process visualisation thanks to large, colour and clear 7" touch panel
- Infinite adjustment and precise output control of between 3% and 100% of the nominal power with display of the ozone volume in "grammes/hour"

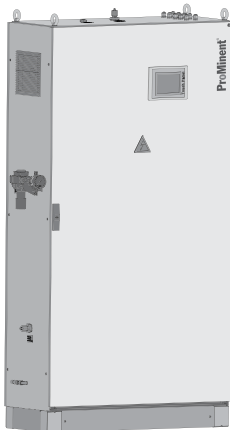

P_PMA_OF_0074_SW

Technical Details

- Compact mounting, ready-to-use in a painted steel cabinet or optionally in a stainless steel cabinet
- With integrated filter package for the removal of dust and small amounts of residual oil in the compressed air
- Special dielectric with excellent cooling: In spite of the low cooling water consumption, heat is quickly and efficiently discharged before the ozone produced can decompose due to excessive heat.
- PLC with integrated ozone measurement and PID control
- 7" touch panel with data logger and screen recorder
- Multiple communication interfaces (e.g. LAN, PROFIBUS® DP)
- Excellent efficiency: Over 90% of the ozone is dissolved in the water, thanks to the special construction of the mixing unit.
- Integration of a dew point sensor to monitor the quality of compressed air
- Integration of an air conditioning unit to adjust the temperature of the ozone system
- Pause input for external switching on/off
- Contact input for locking the system, for example in the absence of flow
- Digital input for connection of a gas detector
- Digital input for control of two power stages
- 0/4-20 mA input for external output control depending on the flow or measured value with a PIC controller
- Second freely configurable 0/ 4-20 mA input
- Contact output for operating status
- Contact output for collective malfunction alert
- Contact output for limit value transgression, ozone concentration in the water too low
- One freely configurable 0/ 4-20 mA output

2 Ozone Systems OZONFILT®

Field of application

- **Potable water supply:** Oxidation of iron, manganese and arsenic, refinement and taste enhancement and disinfection
- **Waste water treatment:** Degradation/reduction of COD and microcontaminants, reduction of sewage sludge
- **Food and beverage industry:** Oxidation of iron and manganese, disinfection of potable water and rinsing water
- **Swimming pools:** Degradation of disinfection by-products, reliable microbiological barrier and production of crystal-clear water thanks to its microfloculating effect
- **Industry:** Legionella prevention and disinfection of cooling water

2 Ozone Systems OZONFILT®

2.5.1

Ozone Generation Systems OZONFILT® OZMa 1-6 A (Operating Gas - Air)

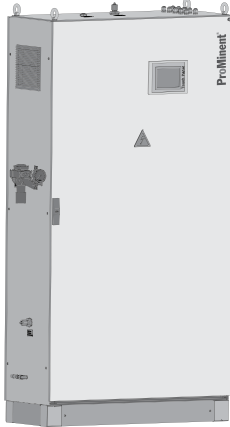

P_PMA_OF_0074_SW

Under nominal conditions, the OZMa 1-6 A range produces up to 420 g/h of ozone from compressed air at a concentration of 20 g/Nm³. Using the designated mixing devices, ozone concentrations of between 3 and 12 ppm can be achieved in the water to be treated, depending on the temperature (theoretical value at 30 or 0 °C).

Different feature options can be achieved by combining different Identity code characteristics.

The plants are pre-mounted ready for connection in a painted steel cabinet (optional stainless steel control cabinet) and need only be connected to a single-phase voltage supply, compressed air, cooling water/waste water and ozone metering point on the customer's site.

An adequate compressed air supply and a mixing device designed for the operating conditions should be integrated for operation of the ozone plant.

Ordering Information for OZONFILT® OZMa Systems see p. → 2-21, Static Helical Mixer Made of PVC or Stainless Steel see p. → 2-24

Mixing equipment

All OZMa systems are delivered, in principle, without a mixing unit and a suitable mixing system has to be ordered separately. When selecting a suitable mixing system, please note that the mixing of ozone is more efficient the higher the water flow in the mixing system. Accordingly design the mixing system so that the flow of the water to be treated is at the upper range of the flow specification.

Static Helical Mixer Made of PVC or Stainless Steel see p. → 2-24

Notes on installation

Keep the length of ozone gas transporting pipes and the number of joints to a minimum. All rooms with a removable joint should be monitored with a gas detector in line with the applicable German accident prevention regulations. All OZONFILT® systems are equipped for fitting Ozone detector.

Ozonisation adds a large amount of gas to the water of which only a small percentage can dissolve. Adequate bleeding should therefore be integrated. Because the gases discharged in this way have a considerable residual ozone concentration, appropriate residual ozone destructors should be installed.

The ozone generator should be interlocked with the water flow into the metering point for all installations.

A non-return valve should be installed between OZMa and the ozone metering point to prevent any return of ozonised water into the ozone-transporting pipe.

Room Air Monitoring see p. → 2-26, Residual Ozone Gas Destructor see p. → 2-25

2 Ozone Systems OZONFILT®

Technical Data

Ozone Generation Systems OZONFILT® OZMa 1-3 A (Process Gas - Air)

Ambient parameters

Max. 85% air humidity of the ambient air, non-condensing, non-corrosive, dust-free, max. ambient temperature: 40 °C (with integrated air conditioning system: 50 °C)

		OZMa 1A	OZMa 2A	OZMa 3A
Number of generator modules		1	1	1
Ozone capacity, measured in accordance with DIN with air at 20 °C, cooling water at 15 °C	g/h	70	105	140
Air consumption (only ozone generation)	Nm ³ /h	3.50	5.25	7.00
Ozone concentration in the gas phase referenced to nominal conditions	g/Nm ³ *	20	20	20
Specific energy requirement at nominal capacity	Wh/g	16.5	16.5	16.5
Power factor at full capacity	cos φ	0.95	0.95	0.95
Ozone connection		Rp 3/8"	Rp 3/8"	Rp 3/8"

* Nm³= m³ at standard conditions (P = 1.013x10⁵Pa, T = 273 K)

Electrical Connection

		OZMa 1A	OZMa 2A	OZMa 3A
Connected load	V/Hz/A	230/50;60/10	230/50;60/16	230/50;60/16
Enclosure rating		IP 54	IP 54	IP 54
Degree of protection with integrated air conditioning unit (internal/external)		IP 54 / IP 34	IP 54 / IP 34	IP 54 / IP 34

Overall Dimensions (Without Mixer)

		OZMa 1A	OZMa 2A	OZMa 3A
Width	mm	1,114	1,114	1,114
Height	mm	1,961	1,961	1,961
Depth	mm	405	405	405

Weight

		OZMa 1A	OZMa 2A	OZMa 3A
Weight	kg	270	280	300

Ozone Mixing

		OZMa 1A	OZMa 2A	OZMa 3A
Max. raw water temperature	°C	35	35	35
Permissible pressure at ozone outlet	bar	0.8–2.0	0.8–2.0	0.8–2.0

Air Supply

		OZMa 1A	OZMa 2A	OZMa 3A
Air demand	NI/min	73	110	147

Air quality oil and dust-free, non-corrosive, constant priming pressure of 4.5 – 10 bar, max. temperature 40 °C

Cooling Water

		OZMa 1A	OZMa 2A	OZMa 3A
Cooling water consumption (15 °C)	l/h	90	135	180
Cooling water consumption (30 °C)	l/h	125	190	250
Cooling water inlet pressure	bar	2–5	2–5	2–5
Cooling water inlet, PE pressure hose	mm	8 x 5	8 x 5	12 x 9
Cooling water outlet, open discharge	mm	8 x 5	8 x 5	12 x 9

Cooling water quality No tendency to form lime scale, no corrosive components, removable substances: < 0.1 ml/l, iron: < 0.2 mg/l, manganese: < 0.05 mg/l, conductivity: > 100 µS/cm, chloride: < 250 mg/l

2 Ozone Systems OZONFILT®

Ozone Generation Systems OZONFILT® OZMa 4-6 A (Process Gas - Air)

Ambient parameters

Max. 85% air humidity of the ambient air, non-condensing, non-corrosive, dust-free, max. ambient temperature: 40 °C (with integrated air conditioning system: 50 °C)

		OZMa 4A	OZMa 5A	OZMa 6A
Number of generator modules		2	2	3
Ozone capacity, measured in accordance with DIN with air at 20 °C, cooling water at 15 °C	g/h	210	280	420
Air consumption (only ozone generation)	Nm ³ /h	10.50	14.00	21.00
Ozone concentration in the gas phase referenced to nominal conditions	g/Nm ³ *	20	20	20
Specific energy requirement at nominal capacity	Wh/g	16.5	16.5	16.5
Power factor at full capacity	cos φ	0.95	0.95	0.95
Ozone connection		Rp 3/8"	Rp 3/8"	Rp 3/8"

* Nm³= m³ at standard conditions (P = 1.013x10⁵Pa, T = 273 K)

Electrical Connection

		OZMa 4A	OZMa 5A	OZMa 6A
Connected load	V/Hz/A	400/50;60/16	400/50;60/16	400/50;60/16
Enclosure rating		IP 54	IP 54	IP 54
Degree of protection with integrated air conditioning unit (internal/external)		IP 54 / IP 34	IP 54 / IP 34	IP 54 / IP 34

Overall Dimensions (Without Mixer)

		OZMa 4A	OZMa 5A	OZMa 6A
Width	mm	1,320	1,320	1,606
Height	mm	1,961	1,961	1,961
Depth	mm	605	605	605

Weight

		OZMa 4A	OZMa 5A	OZMa 6A
Weight	kg	420	445	580

Ozone Mixing

		OZMa 4A	OZMa 5A	OZMa 6A
Max. raw water temperature	°C	35	35	35
Permissible pressure at ozone outlet	bar	0.8–2.0	0.8–2.0	0.8–2.0

Air Supply

		OZMa 4A	OZMa 5A	OZMa 6A
Air demand	NI/min	220	293	440

Air quality oil and dust-free, non-corrosive, constant priming pressure of 4.5 – 10 bar, max. temperature 40 °C

Cooling Water

		OZMa 4A	OZMa 5A	OZMa 6A
Cooling water consumption (15 °C)	l/h	270	360	540
Cooling water consumption (30 °C)	l/h	300	400	600
Cooling water inlet pressure	bar	2–5	2–5	2–5
Cooling water inlet, PE pressure hose	mm	12 x 9	12 x 9	12 x 9
Cooling water outlet, open discharge	mm	12 x 9	12 x 9	12 x 9

Cooling water quality No tendency to form lime scale, no corrosive components, removable substances: < 0.1 ml/l, iron: < 0.2 mg/l, manganese: < 0.05 mg/l, conductivity: > 100 µS/cm, chloride: < 250 mg/l

2 Ozone Systems OZONFILT®

2.5.2

Ozone Generation Systems OZONFILT® OZMa 1-6 O (Operating Gas - Oxygen)

Under nominal conditions, the OZMa 1-6 O range produces up to 735 g/h of ozone from oxygen at a concentration of up to 150 g/Nm³. Using the designated mixing devices, ozone concentrations in the water to be treated of up to 90 ppm can be achieved (theoretical value at 0 °C). Ozone concentration in g/Nm³ and system feed rate in g/h can be varied depending on the operating conditions and can thus be individually matched to the application conditions. Examples for various combinations are listed in the technical data table.

Different feature options can be achieved by combining different Identity code characteristics.

The systems are pre-mounted ready for connection in a painted steel cabinet (optional stainless steel control cabinet) and should only be connected to a single-phase voltage supply, oxygen, cooling water/waste water and ozone metering point on the customer's site.

Ordering Information for OZONFILT® OZMa Systems see p. → 2-21

Mixing equipment

All OZMa systems are delivered, in principle, without a mixing unit and a suitable mixing system has to be ordered separately. When selecting a suitable mixing system, please note that the mixing of ozone is more efficient the higher the water flow in the mixing system. Accordingly design the mixing system so that the flow of the water to be treated is at the upper range of the flow specification.

We recommend using stainless steel mixing systems because of the high ozone concentrations. Mixing systems made of PVC can have a reduced service life, depending on the operating conditions.

Static Helical Mixer Made of PVC or Stainless Steel see p. → 2-24

Notes on installation

Keep the length of ozone gas transporting pipes and the number of joints to a minimum. All rooms with a removable joint should be monitored with a gas detector in line with the applicable German accident prevention regulations. All OZONFILT® systems are equipped for fitting Ozone detector.

Depending on the operating and installation conditions, it might be necessary to also monitor the room air for excessive oxygen content.

All gas-transporting accessories should be resistant to ozone and oxygen (e. g. fat-free).

Ozonisation adds a large amount of gas to the water of which only a small percentage can dissolve. Adequate bleeding should therefore be integrated. Because the gases discharged this way have a considerable residual ozone concentration, appropriate residual ozone destructors should be installed. Because of the high ozone concentrations, only catalytic residual ozone destructors can be used. Activated charcoal-based residual ozone destructors ignite spontaneously if subjected to increased ozone concentrations.

The ozone generator must be interlocked with the water flow into the metering point for all installation.

A non-return valve should be installed between OZMa and ozone metering point to prevent any return of ozonised water into the ozone-transporting pipe.

Room Air Monitoring see p. → 2-26, Residual Ozone Gas Destructor see p. → 2-25

2 Ozone Systems OZONFILT®

Technical Data

Ozone Generation Systems OZONFILT® OZMa 1-3 O (Operating Gas - Oxygen)

Ambient parameters

Max. 85% air humidity of the ambient air, non-condensing, non-corrosive, dust-free, max. ambient temperature: 40 °C (with integrated air conditioning system: 50 °C)

		OZMa 1 O	OZMa 2 O	OZMa 3 O
Number of generator modules		1	1	1
Nominal ozone capacity at 100 g/Nm ³ ** and cooling water at 15 °C	g/h	105	158	210
Ozone capacity at 150 g/Nm ³ *	g/h	60	90	120
Ozone capacity at 80 g/Nm ³	g/h	123	184	245
Specific energy requirement at nominal capacity	Wh/g	9	9	9
Power factor at full capacity	cos φ	0.95	0.95	0.95
Ozone connection		Rp 3/8"	Rp 3/8"	Rp 3/8"

Electrical Connection

		OZMa 1 O	OZMa 2 O	OZMa 3 O
Connected load	V/Hz/A	230/50;60/10	230/50;60/16	230/50;60/16
Enclosure rating		IP 54	IP 54	IP 54
Degree of protection with integrated air conditioning unit (internal/external)		IP 54 / IP 34	IP 54 / IP 34	IP 54 / IP 34

Overall Dimensions

		OZMa 1 O	OZMa 2 O	OZMa 3 O
Width	mm	1,114	1,114	1,114
Height	mm	1,961	1,961	1,961
Depth	mm	400	400	400

Weight

		OZMa 1 O	OZMa 2 O	OZMa 3 O
Weight	kg	220	230	250

Ozone Mixing

		OZMa 1 O	OZMa 2 O	OZMa 3 O
Max. raw water temperature	°C	35	35	35
Permissible pressure at ozone outlet	bar	0.8–2.0	0.8–2.0	0.8–2.0

Specification of Operating Gas: Oxygen

		OZMa 1 O	OZMa 2 O	OZMa 3 O
Gas volume at nominal capacity 100 g/Nm ³	NI/h	1,050	1,580	2,100
Gas volume at capacity 150 g/Nm ³	NI/h	400*	600*	800*
Gas volume at capacity 80 g/Nm ³	NI/h	1,540	2,300	3,100
Concentration min.	vol%	90	90	90
Dew point max.	°C	-50	-50	-50
Pressure	bar	3–6	3–6	3–6
Max. particles	µm	5	5	5
Max. hydrocarbons	ppm	20	20	20
Max. temperature	°C	30	30	30

Cooling Water

		OZMa 1 O	OZMa 2 O	OZMa 3 O
Cooling water consumption (15 °C)	l/h	70	105	140
Cooling water consumption (30 °C)	l/h	115	175	400
Cooling water inlet pressure	bar	1–5	1–5	1–5
Cooling water inlet, PE pressure hose	mm	12 x 9	12 x 9	12 x 9
Cooling water outlet, open discharge	mm	12 x 9	12 x 9	12 x 9

Cooling water quality No tendency to form lime scale, no corrosive components, removable substances: < 0.1 ml/l, iron: < 0.2 mg/l, manganese: < 0.05 mg/l, conductivity: > 100 µS/cm, chloride: < 250 mg/l

* Output 150 g/Nm³ as special version must be factory-set

** Nm³ = m³ at standard conditions (P = 1.013x10⁵ Pa, T = 273 K)

2 Ozone Systems OZONFILT®

Ozone Generation Systems OZONFILT® OZMa 4-6 O (Operating Gas - Oxygen)

Ambient parameters

Max. 85% air humidity of the ambient air, non-condensing, non-corrosive, dust-free, max. ambient temperature: 40 °C (with integrated air conditioning system: 50 °C)

		OZMa 4 O	OZMa 5 O	OZMa 6 O
Number of generator modules		2	2	3
Nominal ozone capacity at 100 g/Nm³ ** and cooling water at 15 °C	g/h	320	420	630
Ozone capacity at 150 g/Nm³ *	g/h	180	240	360
Ozone capacity at 80 g/Nm³	g/h	370	490	735
Specific energy requirement at nominal capacity	Wh/g	9	9	9
Power factor at full capacity	cos φ	0.95	0.95	0.95
Ozone connection		Rp 3/8"	Rp 3/8"	Rp 3/8"

Electrical Connection

		OZMa 4 O	OZMa 5 O	OZMa 6 O
Connected load	V/Hz/A	400/50;60/16	400/50;60/16	400/50;60/16
Enclosure rating		IP 54	IP 54	IP 54
Degree of protection with integrated air conditioning unit (internal/external)		IP 54 / IP 34	IP 54 / IP 34	IP 54 / IP 34

Overall Dimensions

		OZMa 4 O	OZMa 5 O	OZMa 6 O
Width	mm	1,320	1,320	1,606
Height	mm	1,961	1,961	1,961
Depth	mm	605	605	605

Weight

		OZMa 4 O	OZMa 5 O	OZMa 6 O
Weight	kg	420	445	580

Ozone Mixing

		OZMa 4 O	OZMa 5 O	OZMa 6 O
Max. raw water temperature	°C	35	35	35
Permissible pressure at ozone outlet	bar	0.8–2.0	0.8–2.0	0.8–2.0

Specification of Operating Gas: Oxygen

		OZMa 4 O	OZMa 5 O	OZMa 6 O
Gas volume at nominal capacity 100 g/Nm³	NI/h	3,200	4,200	6,300
Gas volume at capacity 150 g/Nm³	NI/h	1,200*	1,600*	2,400*
Gas volume at capacity 80 g/Nm³	NI/h	4,630	6,130	9,190
Concentration min.	vol%	90	90	90
Dew point max.	°C	-50	-50	-50
Pressure	bar	3–6	3–6	3–6
Max. particles	µm	5	5	5
Max. hydrocarbons	ppm	20	20	20
Max. temperature	°C	30	30	30

Cooling Water

		OZMa 4 O	OZMa 5 O	OZMa 6 O
Cooling water consumption (15 °C)	l/h	200	280	420
Cooling water consumption (30 °C)	l/h	300	400	600
Cooling water inlet pressure	bar	1–5	1–5	1–5
Cooling water inlet, PE pressure hose	mm	12 x 9	12 x 9	12 x 9
Cooling water outlet, open discharge	mm	12 x 9	12 x 9	12 x 9

Cooling water quality No tendency to form lime scale, no corrosive components, removable substances: < 0.1 ml/l, iron: < 0.2 mg/l, manganese: < 0.05 mg/l, conductivity: > 100 µS/cm, chloride: < 250 mg/l

* Output 150 g/Nm³as special version must be factory-set

** Nm³= m³at standard conditions (P = 1.013x10⁵Pa, T = 273 K)

2 Ozone Systems OZONFILT®

2.5.3 Ordering Information for OZONFILT® OZMa Systems

OZMa	Type ozone generator
	Air operation / Oxygen operation
	g/h g/h
01	70 105
02	105 158
03	140 210
04	210 320
05	280 420
06	420 630
	Operating gas
A	Operating gas - air
O	Operating gas - oxygen
	Type
P	ProMinent
S	Special version
C	ProMinent with air-conditioning
	Mechanical design
0	Standard (packaging for transport by HGV)
1	Standard (packaging for sea/air freight)
2	In stainless steel cabinet (packaging for transport by HGV)
3	In stainless steel cabinet (packaging for sea/air freight)
M	Modified
	Operating voltage
A	Single-phase 230 V ±10%, 50/60 Hz (only types 01-03)
S	Three-phase 230/400 V ±10%, 50/60 Hz (only types 04-06)
	Gas treatment
0	Gas treatment not integrated (design operating gas - oxygen)
1	Gas treatment integrated without filter package (design operating gas - air)
2	Gas treatment integrated with filter package (design operating gas - air)
3	Gas treatment not integrated (oxygen operating gas version), including gas control valve
4	Gas treatment integrated without filter package (air operating gas version), including gas control valve
5	Gas treatment integrated with filter package (air operating gas version), including gas control valve
	Preset language
DE	german
EN	english
FR	french
IT	italian
ES	spanish
	Control
0	Basic version with digital input to control two power stages
1	External power control via 0/4-20 mA input, data logger
2	External power control, ozone measurement and visualisation via screen recorder, 2 freely configurable 0/4-20 mA inputs, 1 freely configurable 0/4-20 mA output
3	As 2 with additionally integrated PID controller for control of the ozone concentration independent of measured value and flow
	Communication interfaces
0	None
4	PROFIBUS® DP interface
	Additional options
0	None
1	Dew point sensor
	Approvals
01	CE-mark
	Hardware
0	Standard
	Software
0	Standard

Explanation on the Identity code:

Mechanical design: In design 0 and 1, the plant is installed in a standard control cabinet made of powder-coated steel.

Gas treatment: Without filter package for oil-free generated or de-oiled compressed air.
With filter package for compressed air with residual oil content.

2 Ozone Systems OZONFILT®

2.6 Accessories and Spare Parts for Ozone Systems

2.6.1 Compressors for OZONFILT® OZVa 1-4

Atlas Copco LFX compressors

This compressor product range stands out on account of its value for money and is equipped with active start-up unloading and automatic condensation drainage by solenoid valve. The compressors are not suitable for continuous operation and stand out on account of their expected service life of up to 5,000 hours. The efficient use of the compressor can only be guaranteed if the operating duration of the OZVa system can be set as low as possible.

Technical Data

Type		LFX 0.7	LFX 1.5
Free air delivery rate at 7 bar	l/min	61	124
Power consumption at 7 bar	W	530	970
Number of cylinders		1	1
Sound pressure level	dB(A)	62	64
Air receiver capacity	l	20	20
Weight	kg	44	48
Suitable for OZVa Type		1 + 2	3 + 4

Type	Type	Order no.
LFX 0.7	230 V/50 Hz	1004458
LFX 0.7	230 V/60 Hz	1010719
LFX 1.5	230 V/50 Hz	1006343
LFX 1.5	230 V/60 Hz	1009638

Air filter kit

	Order no.
Air filter kit for Atlas Copco LFX compressors	1005789

Dürr ABK compressors

The outstanding feature of this continuously rated range of compressors is their extremely robust construction, making them ideally suitable for industrial use. They are equipped with active start unloading, automatic condensate discharge by solenoid valve and an hours-run meter. PTFE coated special aluminium pistons lead to the long service life and reliability of these compressor units.

Technical Data

Type		TA-080	HA-234
Free air delivery rate at 7 bar	l/min	62	152
Supply max.	VAC	230	230
Supply frequency	Hz	50/60	50
Power consumption at 7 bar	W	800	1,900
Number of cylinders		1	3
Sound pressure level	dB(A)	68	78
Air receiver capacity	l	25	55
Weight	kg	49	70
Suitable for OZVa Type		1 + 2	3 + 4

Type	Order no.
TA-080	1025398
HA-234	1025399

2 Ozone Systems OZONFILT®

Air filter kit

	Order no.
Air filter kit for Dürr ABK compressors*	1025400

* 1 filter kit is required per cylinder.

Compressors with refrigeration drying for operation in conditions of high humidity, and high-capacity screw compressors for connection to several ozone plants are available on request.

2.6.2

Oxygen generator for OZONFILT® OZVa 5-7 and OZMa10

OXYMAT 020 eco

This compact oxygen generator works on the principle of pressure swing filtration of the ambient air through a molecular sieve. Oxygen is generated with a purity of up to 95% and a dew point of – 70°C when supplied with suitably dried compressed air. The system generates a pressure of 4 bar at the oxygen outlet and can be connected directly to the OZVa 5-7 or OZMa 10.

Technical Data

(At 90% oxygen yield):

Type	OXYMAT 020 eco
Capacity	1.6 Nm ³ /h
Air requirement (min. 6 bar)	0.31 Nm ³ /min
Power consumption incl. compressor	2.5 kW
Specific energy requirement	1.4 kWh/Nm ³

Example of an installation

Quantity		Order no.
1	Kaeser SX 3 screw compressor (oil-greased), Motor 2.2 kW, integral cyclone filter	on request
3	Connecting set, Hose with quick-release coupling 1/2" – 3/4" external thread at both sides, length 1.2 m	1025388
2	Pressure tank O ₂ for Oxymat O 020 eco, 90 l, 11 bar, PED with revision opening	1044986
1	Refrigeration dryer ACT 5, 33 Nm ³ /h, 1/230 – 240 V	on request
1	Filter set 006, for LE 2-10 and GX 2-10 FF	1025387
1	Hexagonal reducing piece R 3/4 -Rp 1/2 1.4571	1003366
1	OXYMAT 020 eco, 110-240 V / 50-60 Hz	1044799
1	Connecting set with connections for 6x4 mm PTFE hose, between OXYMAT and OZVa	1025395

Accessories

	Order no.
PTFE hose 6x4 mm, admissible operating pressure 15 bar, sold in metres	037426
Service kit for Atlas Copco LE 2-10, (recommended after 8000 running hours)	1025390
Service kit for Atlas Copco GX 2-10 FF, (recommended after 8000 running hours)	1025391
Service kit 006	1025392
Maintenance set for screw compressor SX3	on request
Maintenance set for OXYMAT 020 eco	on request

2 Ozone Systems OZONFILT®

2.6.3 Static Helical Mixer Made of PVC or Stainless Steel

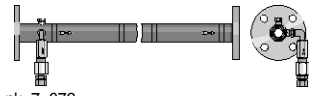

pk_7_072
Static Helical Mixer

Designed for intensive mixing of gas with liquid flows. 4 helical blades ensure optimum mixing of the ozone with minimal pressure drop (0.1 bar per blade at maximum flow). The specified flow range of the static helical mixer should be complied with for optimum mixing results.

Version with loose flanges to DIN 2501 and integrated injection point made from stainless steel with couplings for 12 mm diam. stainless steel tube, or 12/9 mm PTFE hose, using stainless steel support inserts. In addition, the injection point is fitted with a non-return valve to protect the ozone plant from reverse flowing water. The mixers are manufactured as grease-free, so they are also suitable for Types OZVa 5-7. The stainless steel version has a G 1/4" pressure gauge tapping at the ozone mixing point.

Flow m ³ /h	Material	Overall length mm	Connector	Order no.
5 – 10	PVC-U	718	DN 40	1024324
10 – 15	PVC-U	718	DN 50	1024325
15 – 25	PVC-U	718	DN 65	1024326
25 – 35	PVC-U	1,100	DN 80	1024327
35 – 50	PVC-U	1,100	DN 100	1024328
50 – 90	PVC-U	1,300	DN 125	1034641
95 – 160	PVC-U	1,700	DN 150	1034640
5 – 10	1.4404	718	DN 40	1022503
10 – 15	1.4404	718	DN 50	1022514
15 – 25	1.4404	718	DN 65	1022515
25 – 35	1.4404	1,100	DN 80	1022516
35 – 50	1.4404	1,100	DN 100	1024154

Other sizes on request

Connecting parts for the gas pipeline

	Order no.
Stainless steel pipe 12/10 mm, Sold in metres	015743
Stainless steel pipe 12/10 mm, grease-less, 1.4 m	1022463
PTFE hose 12/9 mm, grease-less, sold in metres	037428
Stainless steel support inserts, 2 No. for 12/9 mm PTFE hose, grease-less	1025397
Stainless steel coupling 12 mm - R 1/4, grease-less	1025755
Stainless steel fitting 12 mm - R 3/8, grease-less	1034642
3/8" double nipple	1005825
Stainless steel 90° elbow D 12 - D 12, grease-less	1022462
Stainless steel pressure relief valve, Settable pressure range 0.07 – 2 bar, connector dimension 1/4" NPT, 2 additional inputs for the connection of 2 manometers for OZVa 1 – 7 and OZMa 1 – 3 O	1029032
Stainless steel back pressure valve for OZMa 1 – 3 A and OZMa 4 – 6 O, adjustable pressure range 0.5 – 10 bar, connector G 3/4" external thread, grease-free	1039408
Spare parts kit for back pressure valve order no. 1039408	1039410
Stainless steel back pressure valve for OZMa 4 – 6 A, adjustable pressure range 0.5 – 10 bar, connector G 1 1/4" external thread, grease-free	1039409
Spare parts kit for back pressure valve order no. 1039409	1039411

2 Ozone Systems OZONFILT®

2.6.4 Accessories for OZONFILT® OZMa

The remote control module for OZMa systems enables bidirectional communication with the system control. Communication takes place optionally via a LAN, MPI or USB communication interface.

	Order no.
Remote control module for OZMa systems	On request

2.6.5 Bleed Valves

Suitable for types	Connector	Pressure bar	Max. gas flow at $\Delta p = 0.1$ bar Nm ³ /h	Order no.
OZVa 1 – 7	R 3/4" female; R 1/2" male	0 – 6.0	3.1	302525
OZMa 1 – 30/OZMa 1A	R 1" female; R 1/2" male	0 – 2.0	3.1	302526
OZMa 2-4A / OZMa 4-6O	R 1" female; R 3/4" male	0 – 2.0	14.0	303845
OZMa 2-4A / OZMa 4-6O	DN65" female x 3/4" male	0 – 2.0	25.0	1026373

Bleed valves made of stainless steel 1.4571 in ozone-resistant version for mounting on reaction tanks.

2.6.6 Residual Ozone Gas Destructor

Residual ozone gas destruction is used to remove traces of ozone gas from the exhaust air coming from the reaction tank. Because the exhaust air from the reaction tank still contains water, the pipework should be suitably routed so as to ensure that the water is drained off at the inlet side.

A suitable drainage connection should be provided here too as the exhaust air after the residual ozone gas destructor is still up to 100% saturated with water vapour, and because small temperature fluctuations, even on the outlet side, can lead to flowback of condensate.

The exhaust air from any downstream filter plant that may be fitted can also be routed via this ozone gas destruction unit.

PVC version

Residual ozone destructor based on granular activated carbon in a PVC housing.

	Type	Ozone quantity g/h	Order no.
Residual ozone destructor 3 L	10	10	879022
Residual ozone destructor 14 L	40	40	1004267
Residual ozone destructor 30 L	100	100	879019
Residual ozone destructor 60 L	200	200	879018

Note:

The stated ozone quantities refer to quantities added to the raw water. The residual ozone destructor is designed for the normal residual ozone concentration found in swimming pool applications. It should only be used in plants with air as operating gas and a maximum concentration of 1.5 g of ozone/m³ treated water.

2 Ozone Systems OZONFILT®

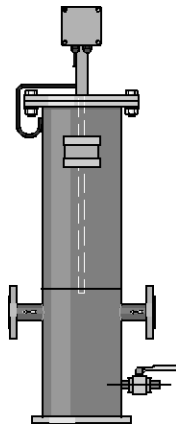

pk_7_073
Residual ozone destructor

Stainless steel version

Residual ozone destructor based on a maintenance-free MnO catalytic converter with integrated heating, 230 V, 50-60 Hz. Connections Rp 1/2" or flanges to DIN 2642, PN10. Types 18 to 110 m³/h also fitted with Rp 1/2" ball valve as condensate drain.

Max. gas flow m ³ /h	Heating power W	Dimensions H x W x D mm	Connector	Order no.
1.5	100	700 x 110 x 180	Rp 1/2"	1018440
8.0	100	735 x 110 x 235	Rp 1/2"	1018406
18.0	140	1,154 x 275 x 240	DN 25	1019155
28.0	140	1,154 x 300 x 259	DN 25	1021037
40.0	500	1,156 x 330 x 264	DN 25	1026335
73.0	500	1,158 x 400 x 320	DN 32	1019971
110.0	500	1,160 x 450 x 375	DN 40	1027238

Note:

The catalytic residual ozone destructor should only be used in chlorine-free gas flows. The PVC version should therefore be used for swimming pool applications.

2.6.7

Room Air Monitoring

Gas detector Neon® Gas Ozone

The gas detector type Neon® Gas Ozone is designed as a compact measuring and switching unit for monitoring the ambient air for dangerous concentrations of ozone.

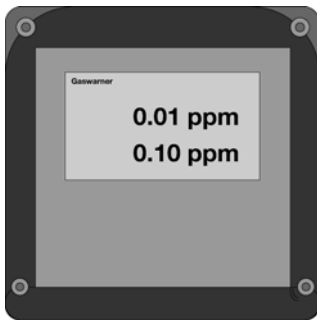

P_DV_0030_SW

Technical Data

Type	Ozone
Warning at approx.	0.3 ppm/vol%
Alarm at approx.	0.5 ppm/vol%
Permissible ambient temperature	0...50°C
Protection class housing	IP 65
Dimensions (without PGs, without sensor) H x W x D	144 x 144 x 156 mm
Supply	85 – 265 / 50 – 60 V/Hz
Power consumption	10 W
Warm-up phase max.	150 s
"Warning" relay contact, self-resetting	250 V ; 6 A
"Alarm" relay contact, latching	250 V ; 6 A
"Horn" relay contact, latching, can be acknowledged	250 V ; 6 A
Sensor measuring principle	electrochemical
Sensor service life (depending on ambient conditions)	1 years

Note: The sensor reacts to all oxidising gases.

	Order no.
Gas detector neon® gas incl. gas sensor, brackets and 10 m connecting cable for 1 sensor	1083254
Ozone sensor 1 ppm	1082470

Accessories for connecting an additional sensor

	Order no.
Gas sensor support	1082466
Connecting cable 5x0.25 mm ² 10 m	1082467

2 Ozone Systems OZONFILT®

Flash light-horn

Combined horn and red warning lamp. IP 33 housing made of impact-resistant grey ABS with a clear polycarbonate dome. Connected load: 230 V AC, 50 mA.

	Order no.
Flash light-horn, red with continuous tone	1083160

Gas tracing pump

Hand operated, non-continuously working test tube pump for fast and accurate measurement of ozone gas. Complete with 10 no. ozone gas test tubes 0.05-5 ppm in carrying case.

	Order no.
Gas tracing pump	1025533

Potassium iodide starch paper

Roll with 4.8 m test strip for leak detection on pipelines carrying ozone gas.

	Order no.
Potassium iodide starch paper	1025575

2.6.8

Cooling Water Heat Exchanger

A heat exchanger can be used as an alternative to the use of fresh water as cooling water. The cooling water is fed through the heat exchanger and ozone system in a circuit. The cooling water heat exchanger discharges the heat to the surroundings.

Technical Data

- Single circuit system with tank open to the atmosphere
- Air-cooled refrigeration unit
- Integral evaporator
- Tank with water level display and level switch with alarm contact
- Microprocessor-controlled temperature controller with digital display
- Integrated circulation pump
- Manometer
- Stainless steel housing
- Installation material with 10 m hose for direct connection to the ozone system
- Electrical contact inputs/outputs: On/Off contact, alarm contact, min. water level contact

Order no.		1075498	1075499	1075501
Refrigerant	CFC-free	R134a	R134a	R134a
Useful cooling output at 20 °C/50 Hz	kW	2.1	2.1	3.0
Working range	°C	+10/+30	+10/+30	+10/+30
Ambient temperature	°C	10 – 55	10 – 55	10 – 55
Pump	Type	Speck, LNY-2841	Speck, LNY-2841	Speck, LNY-2841
Pump capacity at 2 bar	l/min	3.4	3.4	3.4
Water connectors	Inch	6 x 4	12 x 9	12 x 9
Power consumption	kW	1.9	1.9	1.9
Mains connection	V/Hz	230/50 – 60	230/50 – 60	230/50 – 60
Degree of protection	IP	44	44	44
Weight	kg	63	63	83
Outside dimensions (W x D x H)	mm	510x770x500	510x770x500	510x770x500

	Suitable for type	Order no.
Cooling water heat exchanger	OZVa 1 – 7	1075498
	OZMa 1 – 2 A, OZMa 1 – 2 O	1075499
	OZMa 3 A, OZMa 3 O	1075501

2 Ozone Systems OZONFILT®

2.6.9

Personal Protection Accessories

Gas mask

Ozone-resistant, full-face respiratory protective mask with panoramic window shield to EN 136 Class 3. Medium size with EN 148-1 threaded pipe connection. Complete with combination filter NO-P3 and carrying case.

	Order no.
Gas mask	1025574

Warning label

Warning label in accordance with the "Guidelines for the use of ozone for water treatment" ZH 1/474, issued by the central office of the industrial safety associations. Version supplied as a combined adhesive label with markings as follows: warning sign, ozone plant room indication and prohibited activity signs.

	Order no.
Warning label	740921

Emergency stop switch

For installation near the door of the ozone plant room. IP 65 PVC enclosure.

	Order no.
Emergency stop switch	700560

2.6.10

Overvoltage Protection

Overvoltage protection for OZONFILT® systems operated at 230 V 50-60 Hz.

The external overvoltage protection is intended for the operating case where the device internal protection is insufficient for surge voltages of 1 kV between the conductors and of 2 kV to earth. To protect the system when the supply mains is prone to power transients an overvoltage trip can be fitted as a low protection surge arrester to significantly increase the stability of the ozone systems.

Whether the low protection surge arrester requires further measures such as medium and main protection can only be determined by thorough investigation of the voltage behaviour on site.

	Order no.
Fine protection PT 2-DE IS 230 IAC	733010

2.6.11

Replacement Plug-in Insert After Tripping

	Order no.
Replacement plug-in insert PT 2-DE / S 230 / AC - ST	733011

3 Bello Zon® Chlorine Dioxide Systems

3.1 Chlorine Dioxide in Water Treatment

Chlorine dioxide is an exceptionally reactive gas, which is not stored due to its instability but rather must only be manufactured to meet requirements at its place of use in special systems.

Chlorine dioxide has a number of advantages over chlorine, which is predominantly used in the disinfection of water. Thus for instance, the disinfection effect does not reduce with increasing pH-value, as is the case with chlorine, rather it increases slightly. Chlorine dioxide remains stable in pipework systems over long periods of time and provides microbiological protection of the water for many hours and up to several days. Ammonia or ammonium, which cause considerable chlorine loss, do not react with chlorine dioxide so that the metered chlorine dioxide remains fully available for disinfection purposes. Chlorophenols, strongly smelling compounds, which result from the chlorination of water etc., are not formed with chlorine dioxide. Trihalogenmethanes (THMs), a substance class, which, like their main representative, chloroform, is suspected of being carcinogens, result from the reaction of chlorine with dissolved matter naturally found in water (humic acids, fulvic acids, etc.). If chlorine dioxide is used as an alternative disinfectant these substances are not produced.

Advantages of chlorine dioxide:

- Disinfectant effect regardless of the pH value.
- Excellent depositing effect, thanks to long-term stability in the pipework.
- Degradation of biofilms in pipework and tanks, thus reliable protection of entire water systems against legionella attack.
- No reaction with ammonia or ammonium.
- No formation of chlorophenols and other strongly smelling compounds that can be produced during water chlorination.
- No formation of trihalomethanes (THM) or other chlorinated hydrocarbons, no increase in AOX values.

3.1.1 Chlorine Dioxide Applications

With every new project, our engineers draw on experience that we have accumulated since 1976 in the following applications:

Municipal potable water and waste water companies

- Disinfection of potable water
- Disinfection of waste water

Hotels, hospitals, care homes, sports centres etc.

- Combating legionella in cold and hot water systems
- Water disinfection in the cooling towers of air conditioning systems
- Disinfection of swimming pool filters

Food and beverage industry

- Disinfection of product and raw water
- Bottle cleaning, rinsers and pasteurisers
- Cold-sterile bottling systems
- Disinfectant in CIP systems
- Water vapour treatment (condensation) in the milk industry
- Water treatment for fruit, vegetable, seafood, fish and poultry processing

Market gardening

- Disinfection of irrigation water in plant cultivation

Industry

- Cooling water treatment
- Combating legionella in cooling water circuits
- Disinfection of process water
- Removal of odorous substances in air scrubbers
- Slime control in the paper industry

3 Bello Zon® Chlorine Dioxide Systems

3.1.2

Bello Zon® System Technology

Bello Zon® chlorine dioxide generation and metering systems use the chlorite/acid process. These systems generate a chlorine-free chlorine dioxide solution through the reaction of sodium chlorite solution with hydrochloric acid.

Decades of experience with Bello Zon® chlorine dioxide systems have shown that using the selected process parameters can achieve an excellent output of up to 99% (relative to the stoichiometric ratio).

In most applications, metering is proportional to the flow, i.e. the flow depends on the signal from an inductive or contact flow meter or is performed in parallel to a feed pump.

In circulation systems, such as bottle washing machines, cooling circuits, etc., where a chlorine dioxide loss need only be made good, the addition can also be controlled based on a measurement of chlorine dioxide.

Features

- Precise and reproducible chlorine dioxide production, thanks to the use of calibratable metering pumps for the starting chemicals.
- Convenient easy operation, thanks to microprocessor control with display of all relevant operating parameters and error messages in plain text.
- Display of the current production quantity as well as the flow rate of the connected flow meters with CDV and CDK.
- Integrated measurement of ClO₂ and chlorite plus control of ClO₂ with CDV and CDK.
- Highest safety level provided as standard, thanks to construction and operation in accordance with DVGW specifications W 224 and W 624.

Bello Zon® CDL

Compact dimensions and maximum cost-effectiveness - chlorine dioxide system for one or more points of injection.

0 – 120 g/h capacity with storage of up to 60 g of chlorine dioxide for peak metering. Max. flow rate at 0.2 ppm ClO₂ metering capacity of 600 m³/h

Bello Zon® CDE

Bello Zon® CDEb is winning over customers, thanks to its ultra-simple operation and clearly laid out construction.

5-200 g/h chlorine dioxide. Max. flow at 0.2 ppm ClO₂ metering is 1,000 m³/h

Bello Zon® CDV

Bello Zon® CDVc is the convenient system for the treatment of average to large volumes of water.

1 – 2,000 g/h chlorine dioxide. Max. flow at 0.2 ppm ClO₂ metering is 10,000 m³/h

Bello Zon® CDK

Bello Zon® CDKc is a deluxe system, persuading customers with its safe handling of chemicals.

8 – 12,000 g/h chlorine dioxide. Max. flow rate at 0.2 ppm ClO₂ metering is 60,000 m³/h

ProMinent provides all the advice needed for the safe operation of a chlorine dioxide system:

- Evaluation of the situation on site by trained, expert field sales staff.
- Interpretation of water analysis.
- Project planning of the system.
- Commissioning and system maintenance by our trained service technicians.

3 Bello Zon® Chlorine Dioxide Systems

3.2 Performance Overview of Chlorine Dioxide Systems

Type [g/h]	CDLb	CDEb	CDVc	CDKc
15.000				
10.000				8 – 12.000
5.000				
1.000			1 – 2.000	
500				
100	0 – 120	5 – 200		
50				
10				
5				

Manufacturing method

	Chlorite-Acid (depleted) 7,5 % NaClO ₂ + 9 % HCl	Chlorite-Acid (depleted) 7,5 % NaClO ₂ + 9 % HCl	Chlorite-Acid (depleted) 7,5 % NaClO ₂ + 9 % HCl	Chlorite-Acid (concentrated) 24,5 % NaClO ₂ + 25-37 % HCl
--	--	--	--	---

Application

Legionella combating	■			
Food and beverages industry	■	■	■	
Municipal drinking and waste water treatment	■	■	■	■
Industry (cooling tower, waste/ process water, etc.)	■	■	■	■

P_PMA_BEZ_0161_SW

Chlorine dioxide is establishing itself more and more as a universal disinfectant in applications such as the disinfection of drinking water and industrial water, washing food or in the treatment of cooling water and waste water. Its effect independent of the pH value of the water ensures systems remain free of biofilms.

- Efficient disinfection in connection with excellent eco-compatibility
- Safe and reliable plant technology
- Worldwide availability of know-how and service

3 Bello Zon® Chlorine Dioxide Systems

3.3 Questionnaire on the Design of a Chlorine Dioxide System

Use of the chlorine dioxide plant:

- for disinfection of
 - Drinking water
 - Industrial water
 - Process water in the food industry
 - Waste water
 - Cooling water
 - _____
- for oxidation of
 - Iron, manganese, nitrite, sulphide etc.
 - Swimming pool water
 - Odour
 - _____
- _____

Water values:

- | | | | |
|------------------------------|-----------------------------------|---|--|
| Max. water flow rate | _____ m ³ /h | Maximum water pressure | _____ bar |
| Water flow rate | <input type="checkbox"/> constant | <input type="checkbox"/> fluctuating from | _____ m ³ /h to _____ m ³ /h |
| pH value | _____ | Iron (Fe ²⁺) | _____ mg/l |
| Temperature | _____ °C | Manganese (Mn ²⁺) | _____ mg/l |
| Solid fraction | _____ mg/l | Nitrite (NO ₂ ⁻) | _____ mg/l |
| Alkalinity K _{S4,3} | _____ mmol/l | Sulphide (S ²⁻) | _____ mg/l |
| | | TOC (total organic carbon) | _____ mg/l |

Response time to application:

_____ m³ volume reaction tank or _____ minutes residence time in entire system.

Type of metering:

- constant
- flow-proportional
- depending on measured value

Desired amount of metering: _____ mg/l

Desired concentration after chlorine dioxide metering: _____ mg/l

Other requirements:

3

3 Bello Zon® Chlorine Dioxide Systems

3.4 Chlorine Dioxide System Bello Zon® CDLb

Compact dimensions and maximum cost-effectiveness - chlorine dioxide system for one or more points of injection.

0 – 120 g/h capacity with storage of up to 60 g of chlorine dioxide for peak metering. Max. flow rate at 0.2 ppm ClO₂ metering capacity of 600 m³/h



Chlorine dioxide system for production of a chlorine-free chlorine dioxide solution, especially suitable for multiple points of injection. Bello Zon® CDLb produces ClO₂ discontinuously using the acid/chlorite process with diluted chemicals.

In batch production a chlorine-free chlorine dioxide solution is generated from a sodium chlorite solution and hydrochloric acid. This is an extremely safe, managed process.

The concentration of the chlorine dioxide solution remains constant even during storage. This means that the chlorine dioxide can be buffered in an integrated or external storage module at a concentration of 1,000 or 2,000 mg/l.

Because the chlorine dioxide is buffered in this module, the system can be designed in line with average rather than peak consumption. This drastically reduces investment costs in comparison with conventional systems.

The ProMinent® product range includes a wide range of metering pumps and control versions from which to choose when operating several injection points using chlorine dioxide from a storage module.

No chlorine dioxide can escape from the system due to the closed gas transport system, thereby guaranteeing economical, environmentally friendly operation with minimal use of chemicals. In addition, the chlorine dioxide solution generated with maximum output offers excellent long-term stability with minimal consumption of starting chemicals.

Integration of the system into your process is simple and reliable with the wide range of accessory modules. Please ask our sales representatives for information about our modular systems specifically designed for CDLb.

The chlorine dioxide system Bello Zon® CDLb meets the high standards stipulated in data sheets W 224 and W 624 published by the German Association for Gas and Water (DVGW).



P_PMA_BEZ_0077_SW

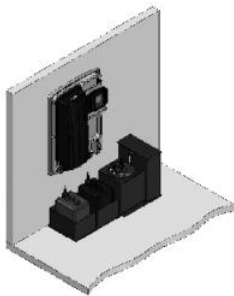

P_PMA_BEZ_0122_SW

Your benefits

- Reduced costs thanks to minimal use of chemicals
- Cost-effective way to provide several points of injection
- Quick ramp-up time after downtime thanks to long-term stability of chlorine dioxide solution
- Maximum output due to closed gas transport system
- Outstanding operating safety and reliability, thanks to intrinsically safe process control
- Ultra-simple process integration

Technical Details

Voltage supply	100 – 230 V, 50/60 Hz (16 A)
Inputs	2 freely configurable digital inputs for the functions Pause, High metering, Intermittent metering or Manual metering, as well as an external collective malfunction signal 4 digital inputs for monitoring (warning / empty message) the chemical supply 1 digital input for contact water meter 0.25-20 Hz 1 frequency input for water meter 10-10,000 Hz
Outputs	1 operating signal relay 1 alarm signal relay 1 warning signal relay 1 voltage output +5 V as supply voltage for a water meter with Hall sensor
Operating fluids	Sodium chlorite 7.5%, purity according to EN 938 Hydrochloric acid 9% purity according to EN 939 Potable water
Enclosure rating	IP 65

Field of application

- Disinfection in the food and beverage industry. Especially for bottle rinsers, CIP (cleaning in place), bottle washing machines and fruit / vegetable washing
- Legionella control and prevention, e.g. in hotels or hospitals
- Market gardening: Germ-free irrigation water and sprinkler irrigation water
- Treatment of cooling water and potable water
- Filter disinfection, e.g. in swimming pools

3 Bello Zon[®] Chlorine Dioxide Systems

Technical Data

Type	Generation capacity g/h	Operating temp. °C	Solution concentration mg/l	Capacity l/h	Dimensions (approx.) H x W x D (mm) mm	Weight kg
CDLb 06	6*	10–40	1,000	8	1,236 x 878 x 306	41
CDLb 12	12*	10–40	2,000	8	1,236 x 878 x 306	42
CDLb 22	22*	10–40	2,000	13	1,236 x 878 x 306	46
CDLb 55	55* 1)	10–40	2,000	30	1,550 x 800 x 345	73
CDLb 120	120** 1)	10–40	2,000	**	1,300 x 880 x 425	55

* Option: Integrated receiver tank and integrated metering pump with suitable capacity up to 7 bar back pressure.

** With external receiver module and separate metering pump

1) Without cover

Interfaces

Type CDLb		6 g/h	12 g/h	22 g/h	55 g/h	120 g/h
Water inlet	ProMinent/Neutral	12-9	12-9	12-9	12-9	Di20/DN15
	Swiss	Di20/DN15	Di20/DN15	Di20/DN15	Di20/DN15	Di20/DN15
Connector dimensions of metering pump for acid and chlorite		6x4	6x4	6x4	6x4	6x4
ClO₂ outlet	With internal storage/pump/multifunctional valve	6-4	6-4	12-9	12-9	
	With internal storage tank/pump	6-4	6-4	12-9	12-9	
	With internal storage tank, without pump	6-4	6-4	8-5	12-9	
	With external storage tank, without pump (reactor outlet)	12-9	12-9	12-9	12-9	Di25/DN20
	External storage tank (suction lance connector)	Di25/DN20	Di25/DN20	Di25/DN20	Di25/DN20	Di25/DN20

3 Bello Zon® Chlorine Dioxide Systems

3.4.1 Identity code ordering system for chlorine dioxide systems Bello Zon® CDLb

CDLb	ClO ₂ production capacity		
02	CDLb 06 = 6 g/h		
04	CDLb 12 = 12 g/h		
06	CDLb 22 = 22 g/h		
08	CDLb 55 = 55 g/h, cover now included with the scope of delivery		
10	CDLb 120 = 120 g/h, cover now included with the scope of delivery		
Equipment			
0	With receiver tank, pump and multifunctional valve (not with CDLb 120) *		
1	With receiver tank and pump (not with CDLb 120) *		
2	With receiver tank, without pump (not for CDLb 120)		
3	With 30 l receiver module, without pump		
Design			
P	ProMinent		
S	Swiss, DN 15 water connection, rigid piping		
N	Neutral		
Operating voltage			
0	230 V, 50/60 Hz		
1	115 V, 50/60 Hz		
Suction lance, suction assembly			
0	None		
1	With suction lance		
2	With suction lance and collecting pan		
3	With suction lance, collecting pan, angle valve and PE hose 12x9 (10 m)		
Pre-set language			
DE	german	HU	Hungarian
EN	english	PT	Portuguese
ES	spanish	NL	Dutch
FR	french	SL	Slovenian
IT	italian	RO	Romanian
PL	polish	CN	Chinese
CZ	czech	DK	Danish
FI	Finnish		

* ClO₂ discharge pumps are not equipped with a fault indicating relay. It is available as an accessory.

3.4.2 Accessories and Maintenance Sets for Chlorine Dioxide Systems Bello Zon® CDLb

Point of injection

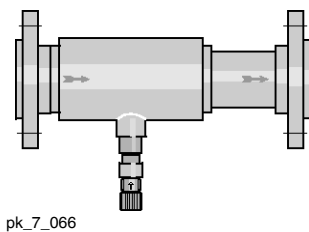

Corrosion-resistant point of injection made of PVC-U or PVC-C for warm water applications with integrated mixer elements and maintenance-free PVDF metering valve.

CDL points of injection with flange	Material	Installation length	Order no.
mm			
CDL DN 50 point of injection	PVC-U	450	1027611
CDL DN 65 point of injection	PVC-U	400	1026490
CDL DN 80 point of injection	PVC-U	400	1027612
CDL DN 100 point of injection	PVC-U	470	1034693
CDL DN 125 point of injection	PVC-U	550	1047692
CDL DN 150 point of injection	PVC-U	680	1047693
CDL DN 50 point of injection	PVC-C	450	1080375
CDL DN 65 point of injection	PVC-C	400	1029326
CDL DN 80 point of injection	PVC-C	400	1029327
CDL points of injection with threaded connector (including separate reductions in each case to one nominal width smaller)	Material	Order no.	
CDL DN 25 point of injection	PVC-C	1080362	
CDL DN 40 point of injection	PVC-C	1080374	
CDL DN 25 point of injection	PVC-U	1080359	
CDL DN 40 point of injection	PVC-U	1080361	

3 Bello Zon® Chlorine Dioxide Systems

Temperature/pressure resistance – metering station CDL

Water temperature (°C)	Maximum permissible operating pressure (bar)	
	PVC-U	PVC-C
40	12	12
50	7	9.5
60	4.5	7.5
70	–	5
80	–	3

Back pressure valve and angle valve

Back pressure valve type MFV with wall bracket and 6 x 4 mm hose connection is ideal for fitting in the chlorine dioxide metering line. Angle valve for the transition from the customer's pipeline to the 12x9 hose connector on the CDLb.

	Order no.
MFV pressure relief valve with wall mounting bracket	1027652
Angle valve (support insert 12/9 stainless steel) DN15 G 1/2" brass	1046350

Fault indicating relay for the ClO₂ pump

Fault indicating relay retrofit kit for the ClO₂ discharge pump

	Order no.
Relay 3-pin	1029309

Hood for CDLb

	Order no.
Hood for CDLb 55 PE black	1045889
Hood for CDLb 120 PE black	1045890

Safety collecting pan for chemical containers

Collecting pan with two separate compartments - 1 No. 25 l Bello Zon® acid and 1 No. 10 l Bello Zon® chlorite chemical container.

Dimensions (HxWxD): 290 x 700 x 350 mm

	Order no.
Safety collecting pan CDLa	1026744

Safety collecting pan for chemical tanks (CDLb)

Collecting pan for a 25 l Bello Zon® acid or Bello Zon® chlorite chemical canister.

Dimensions (HxWxD): 266 x 400 x 500 mm

	Order no.
Safety collecting pan CDLb	791726

Service kits for CDLa

The kits contain all parts subject to wear and tear that need to be replaced at regular service intervals. The 1-year kit should be used every year and the 3-year kit in addition every 3 years.

	Order no.
1-year service kit for pressure relief valve	1029442

3 Bello Zon® Chlorine Dioxide Systems

For CDLa with ClO₂ pump

	Type	Order no.
Annual maintenance kit, 230 V	CDL 5	1027263
3-yearly maintenance set, 230 V	CDL 5	1049659
Annual maintenance kit, 230 V	CDL 10	1031549
3-yearly maintenance set, 230 V	CDL 10	1049665
Annual maintenance kit, 115 V	CDLa 5	1080108
3-yearly maintenance set, 115 V	CDLa 5	1049657
Annual maintenance kit, 115 V	CDLa 10	1080110
3-yearly maintenance set, 115 V	CDLa 10	1049663

For CDLa without ClO₂ pump

	Type	Order no.
Annual maintenance kit, 230 V	CDL5	1042829
3-yearly maintenance set, 230 V	CDL5	1049660
Annual maintenance kit, 230 V	CDL10	1042830
3-yearly maintenance set, 230 V	CDL10	1049666
Annual maintenance kit, 115 V	CDLa 5	1080107
3-yearly maintenance set, 115 V	CDLa 5	1049658
Annual maintenance kit, 115 V	CDLa 10	1080109
3-yearly maintenance set, 115 V	CDLa 10	1049664

Maintenance sets for Bello Zon® CDLb

For CDLb with storage tank, pump and back pressure valve

	Type	Order no.
Annual maintenance kit, 230 V	CDLb 06, CDLb 12	1044484
Annual maintenance kit, 230 V	CDLb 22	1044501
Annual maintenance kit, 230 V	CDLb 55	1044509
Annual maintenance kit, 115 V	CDLb 06, CDLb 12	1079198
Annual maintenance kit, 115 V	CDLb 22	1079202
Annual maintenance kit, 115 V	CDLb 55	1079206
3-yearly maintenance set, 230 V	CDLb 06, CDLb 12	1044494
3-yearly maintenance set, 230 V	CDLb 22	1044502
3-yearly maintenance set, 230 V	CDLb 55	1044510
3-yearly maintenance set, 115 V	CDLb 06, CDLb 12	1045212
3-yearly maintenance set, 115 V	CDLb 22	1045216
3-yearly maintenance set, 115 V	CDLb 55	1045220

For CDLb with receiver tank and pump

	Type	Order no.
Annual maintenance kit, 230 V	CDLb 06, CDLb 12	1044495
Annual maintenance kit, 230 V	CDLb 22	1044503
Annual maintenance kit, 230 V	CDLb 55	1044511
Annual maintenance kit, 115 V	CDLb 06, CDLb 12	1079199
Annual maintenance kit, 115 V	CDLb 22	1079203
Annual maintenance kit, 115 V	CDLb 55	1079207
3-yearly maintenance set, 230 V	CDLb 06, CDLb 12	1044496
3-yearly maintenance set, 230 V	CDLb 22	1044504
3-yearly maintenance set, 230 V	CDLb 55	1044512
3-yearly maintenance set, 115 V	CDLb 06, CDLb 12	1045213
3-yearly maintenance set, 115 V	CDLb 22	1045217
3-yearly maintenance set, 115 V	CDLb 55	1045221

3 Bello Zon® Chlorine Dioxide Systems

For CDLb with receiver tank without pump

	Type	Order no.
Annual maintenance kit, 230 V	CDLb 06, CDLb 12	1044497
Annual maintenance kit, 230 V	CDLb 22	1044505
Annual maintenance kit, 230 V	CDLb 55	1044513
Annual maintenance kit, 115 V	CDLb 06, CDLb 12	1079200
Annual maintenance kit, 115 V	CDLb 22	1079204
Annual maintenance kit, 115 V	CDLb 55	1079208
3-yearly maintenance set, 230 V	CDLb 06, CDLb 12	1044498
3-yearly maintenance set, 230 V	CDLb 22	1044506
3-yearly maintenance set, 230 V	CDLb 55	1044514
3-yearly maintenance set, 115 V	CDLb 06, CDLb 12	1045214
3-yearly maintenance set, 115 V	CDLb 22	1045218
3-yearly maintenance set, 115 V	CDLb 55	1045222

For CDLb with 30 l receiver module without pump

	Type	Order no.
Annual maintenance kit, 230 V	CDLb 06, CDLb 12	1044499
Annual maintenance kit, 230 V	CDLb 22	1044507
Annual maintenance kit, 230 V	CDLb 55	1044515
Annual maintenance kit, 230 V	CDLb 120	1044517
Annual maintenance kit, 115 V	CDLb 06, CDLb 12	1079201
Annual maintenance kit, 115 V	CDLb 22	1079205
Annual maintenance kit, 115 V	CDLb 55	1079209
3-yearly maintenance set, 230 V	CDLb 06, CDLb 12	1044500
3-yearly maintenance set, 230 V	CDLb 22	1044508
3-yearly maintenance set, 230 V	CDLb 55	1044516
3-yearly maintenance set, 230 V	CDLb 120	1044519
3-yearly maintenance set, 115 V	CDLb 06, CDLb 12	1045215
3-yearly maintenance set, 115 V	CDLb 22	1045219
3-yearly maintenance set, 115 V	CDLb 55	1045223
3-yearly maintenance set, 115 V	CDLb 120	1044519

3 Bello Zon® Chlorine Dioxide Systems

3.5 Chlorine Dioxide System Bello Zon® CDLb with Multiple Points of Injection

The modular customised solution for several ClO₂ points of injection with only one generation system.

0 – 120 g/h capacity with storage of up to 60 g of chlorine dioxide for peak metering. Max. flow rate at 0.2 ppm ClO₂ metering capacity of 600 m³/h, up to 6 points of injection possible as standard

Flexible solutions for the production and metering of ClO₂ adapted to our customer's tasks, requirements and anticipated pricing.



The Bello Zon® chlorine dioxide systems for multiple metering are divided into three different concepts designed to respond to specific customer requirements. These concepts are used where several points of injection need to be supplied with ClO₂ from a single ClO₂ system. Up to 6 points of injection can be selected as standard depending on the chosen concept.

Concept 2 (assembly kit of metering components ready mounted on plate)

This concept consists of two main components, the CDLb system and a metering panel, on which all the metering components are mechanically and, optionally, electrically ready mounted.

Concept 3 (plug and play on stainless steel frame)

This concept consists of a stainless steel frame, on which the BelloZon® CDLb system and the metering components are mechanically and electrically mounted in full. There is a stainless steel control cabinet with a main switch that contains the central power supply and control system for all electrical components.

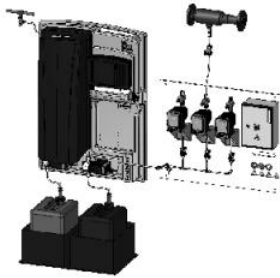

P_PMA_BEZ_0021_SW1
Concept 2

Your benefits

- Very easy way to provide several points of injection according to requirements
- Cost-effective way to provide several points of injection
- Outstanding operating safety and reliability, thanks to intrinsically safe process control
- Ultra-simple process integration

Technical Details

- External storage module
- Internal storage tank (only with the "Modular, loose components" and "Modular, metering components pre-assembled on a panel" concepts)
- Terminal box with optional main switch (only with the "Modular, metering components pre-assembled on a panel" concept)
- Stainless steel cabinet with main switch and emergency relay (only with the "Plug and Play on stainless steel frame" concept)

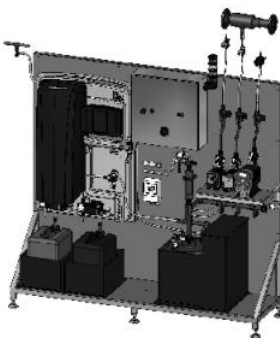

P_PMA_BEZ_0020_SW1
Concept 3

Field of application

- All applications which require more than one point of injection
- Disinfection in the food and beverage industry. Especially with bottle rinsers, CIP (cleaning in place), bottle washing machine and in fruit / vegetable washing
- Legionella control and prevention, e.g. in hotels or hospitals (cold and hot water metering)
- Market gardening: germ-free irrigation and sprinkler irrigation water
- Treatment of cooling water and potable water
- Filter disinfection, e.g. in swimming pools

3 Bello Zon® Chlorine Dioxide Systems

3.6 Chlorine Dioxide System Bello Zon® CDEb



Bello Zon® CDEb is winning over customers, thanks to its ultra-simple operation and clearly laid out construction.

5-200 g/h chlorine dioxide. Max. flow at 0.2 ppm ClO₂ metering is 1,000 m³/h

Chlorine dioxide system, which continuously produces ClO₂ according to the acid/chlorite method with diluted chemicals. Extremely simple operation, clear construction, analogue control, manual control or via contacts.

A ready-to-use chlorine dioxide system for the continuous production and metering of chlorine dioxide with diluted chemicals. The emphasis is on ultra-simple operation and clearly laid out system design with standard components.

The stroke lengths of the metering pumps are continuously monitored. This rules out inadmissible operating statuses arising from incorrect pump stroke length adjustments.

The system is extremely easy to operate and, alongside a central Start-Stop key, also has colour-differentiated LEDs to display all the operating statuses.

The system can be controlled in an analogue or manual manner or via contacts

Your benefits

- Minimal training required thanks to extremely simple operation
- Minimal investment costs
- Short lead times
- Excellent operating safety
- Simple process integration

Technical Details

Power supply

- 100-230 V, 50/60 Hz

Inputs

- 1 digital input for the Pause function
- 1 digital input for contact water meter 0.25-20 Hz
- 1 analogue input 0/4-20mA

Outputs

- 1 alarm signal relay
- 1 warning signal relay

Operating substances

- Sodium chlorite 7.5%, purity according to EN 938
- Hydrochloric acid 9% purity according to EN 939
- Particle-free water

Degree of protection

- IP 54

Bypass pipework

- DN 20

Field of application

- Municipal potable water and waste water treatment
- Industrial process and cooling water
- Disinfection in the food and beverage industry

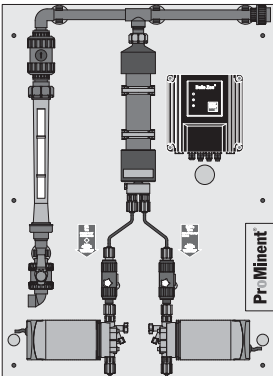

P_PMA_BEZ_0163_SW

3 Bello Zon® Chlorine Dioxide Systems

Technical Data

Type	Chlorine dioxide capacity*		Max. operating pressure **	Operating temp. °C	Connector size, chlorite and acid metering pumps	Dimensions H x W x D mm	Dimensions of the bypass connector DN	Weight kg
	min.-max./hour g/h	min./day g/d						
CDEb 30	5-30	10	7 / 8 **	15-40	6x4	958 x 700 x 250	20	23
CDEb 75	10-75	20	7 / 8 **	15-40	6x4	958 x 700 x 250	20	24
CDEb 200	20-200	40	7 / 8 **	15-40	8x5	958 x 700 x 250	20	27

* The metering figures relate to 5 bar back pressure and an ambient temperature of 20 °C. The minimum capacity/per hour is based on the fact that when the system is operating at below 10 % of the nominal capacity, continuous metering is no longer possible, due to the then low pumping frequency of the metering pumps. Where systems are operating continuously, change the reactor content at least 2 x daily. Do not operate at below the specific minimal output/day.

** 8 bar at maximum 35 °C ambient temperature

Subject to technical and design changes

Type	Order no.
CDEb 30	1079438
CDEb 75	1079439
CDEb 200	1079440

Scope of supply:

Bello Zon® CDEb systems are supplied connection-ready on a wall panel. Connection to the site bypass line is via DN 20 PVC threaded connectors with straight solvent unions. Order suction lances for the chemical pumps, safety collecting pans for the chemical drums and other accessories, like flushing equipment with a vacuum relief valve separately.

3 Bello Zon® Chlorine Dioxide Systems

3.7

Chlorine Dioxide System Bello Zon® CDVc

Bello Zon® CDVc is the convenient system for the treatment of average to large volumes of water. 1 – 2,000 g/h chlorine dioxide. Max. flow at 0.2 ppm ClO₂ metering is 10,000 m³/h



Chlorine dioxide system for monitoring and metering chlorine dioxide and diluted chemicals. Maximum output and safety due to special reactor concept. Bello Zon® CDVc can be easily and safely integrated into any water treatment process.

Continuous water treatment using the chlorine dioxide system Bello Zon® CDVc can be simply and safely integrated into any process. The special reactor concept generates chlorine dioxide safely and simply with maximum output.

Food-compatible PVDF is used instead of PVC generally used in the industry. This results in improved operating safety and reliability and improved purity of the chlorine dioxide generated. The central system controller manages the precise production of the chlorine dioxide. All parameters relevant for water treatment are recorded and logged.

The stroke lengths of ProMinent® metering pumps are monitored online. This rules out hazardous operating statuses arising from incorrect pump stroke length adjustments.

The precise production of chlorine dioxide is managed by the central system control. Chlorine dioxide, chlorite, pH or ORP potential sensors DULCOTEST® are directly connected to the two mA inputs. The chlorine dioxide is monitored in the treated water and documented. The chlorine dioxide concentrations in the water can be adjusted automatically depending on the measurement by the integrated PID controller.

The integrated data logger documents all status messages and measured values, which the screen writer then visualises on the clear colour display.

The systems meet all the requirements of the DVGW specifications W 224 and W 624 with regard to construction and operation and are designed for operation with diluted chemicals Bello Zon® chlorite (7.5% NaClO₂) and acid (9% HCl).

Your benefits

- Efficient operation, thanks to production, metering and monitoring of ClO₂ with just one system
- Maximum operating safety and purity of the ClO₂ produced through the use of PVDF reactors and stroke length-monitored pumps
- No need for external control due to integrated measuring and control technology
- Perfect quality management, thanks to integrated storage of all operating parameters and measured values
- Automatic monitoring of operating parameters and maintenance intervals
- Simple and safe operation, thanks to clear navigation in plain text

Technical Details

Power supply

- 100-230 V, 50/60 Hz

Inputs

- 2 freely configurable analogue inputs (0/4-20 mA)
- 7 digital inputs for monitoring
- 1 digital input for contact water meter 0.25-20 Hz
- 1 frequency input for water meter 10-10,000 Hz

Outputs

- 1 operating signal relay
- 1 alarm signal relay 1 warning signal relay
- Mains output for controlling the bypass pump
- 1 freely configurable analogue output (0/4-20 mA)
- 1 voltage output +5 V as supply voltage for water meter with Hall sensor

Operating substances

- Sodium chlorite 7.5%, purity according to EN 938
- Hydrochloric acid 9% purity according to EN 939
- Particle-free water

Degree of protection

- IP 65

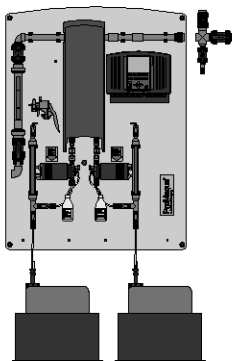

P_PMA_BEZ_0009_SW
CDVc 20-120 (figure shows optional configuration)

3 Bello Zon® Chlorine Dioxide Systems

Field of application

- Municipal potable water and waste water treatment
- Industrial process and cooling water
- Disinfection in the food and beverage industry, above all with inlet water treatment.
- Market gardening: Germ-free irrigation water and sprinkler irrigation water

Technical Data

Type	Chlorine dioxide dosing capacity*		Max. operating pressure** bar	Operating temp. °C	Dimensions*** H x W x D (mm) mm	Weight*** kg	Power consumption (max.)****	
	min.-max./hour g/h	min./day g/d					230 V A	115 V A
CDVc 20	1–20	6.4	8	10–40	1,344 x 1,002 x 200	26	2.7	0.9
CDVc 45	2–45	16.0	8	10–40	1,344 x 1,002 x 200	27	2.7	0.9
CDVc 120	6–120	40.0	8	10–40	1,344 x 1,002 x 200	28	2.7	0.9
CDVc 240	12–240	80.0	8	10–40	1,342 x 1,000 x 248	45	2.7	1.2
CDVc 600	30–600	140.0	8	15–40	1,711 x 1,200 x 273	75	2.8	1.4
CDVc 2000	100–2,000	468.0	5	15–40	1,900 x 1,400 x 370	120	4.1	3.2

* The metering figures relate to 5 bar back pressure and an ambient temperature of 20 °C. The minimum capacity/per hour is based on the fact that when the system is operating at below 5% of the nominal power, continuous metering is no longer possible because of the correspondingly low pumping frequency of the metering pumps. When systems are not operating continuously, the reactor contents should be changed at least twice daily. The system should not, therefore, be operated below the stated minimum capacity/day.

** At 35 °C ambient temperature

*** Without bypass pump, flushing valve and water supply line

**** 230 V values with bypass pump, 115 V values without bypass pump

Interfaces

Type	Chlorine dioxide dosing capacity*		Hose connection dimensions of metering pumps	Dimensions of the bypass connector pumps DN
	min.-max./hour g/h	min./day g/d		
CDVc 20	1–20	6.4	6x4	25
CDVc 45	2–45	16.0	6x4	25
CDVc 120	6–120	40.0	6x4	25
CDVc 240	12–240	80.0	8x5	25
CDVc 600	30–600	140.0	8x5	25
CDVc 2000	100–2,000	468.0	DN 10	40

3 Bello Zon® Chlorine Dioxide Systems

3.7.1 Identity Code Ordering System for CDVc Systems

CDVc	System type, metering output ClO₂	
02	CDVc 20=	20 g/h
04	CDVc 45=	45 g/h
06	CDVc 120=	120 g/h
08	CDVc 240=	240 g/h
10	CDVc 600=	600 g/h
14	CDVc 2000=	2,000 g/h
	Type	
P	ProMinent	
	Power supply	
U	100-230 V ± 10%, 50/60 Hz	
A	230 V ± 10%, 50/60 Hz	
B	100-115 V ± 10%, 50/60 Hz (not available for version with „bypass“ 04)	
	Bypass version	
02	PVC-U bypass with float flow meter, unit l/h	
04	Bypass PVC-U with float flow meter (not CDVc 2000), only selectable with operating voltage A and 50 Hz mains frequency, unit l/h	
08	PVC-U bypass with float flow meter, unit gpm	
	Calibration device	
0	Without calibration device, but with measuring cylinder	
1	With calibration device	
	Suction lance, suction fitting, chemicals	
0	none	
1	Suction lance for 5-60 l container (only CDV 20-600)	
2	Suction lance for 200 l container (only CDV 20-600)	
3	Flexible suction fitting up to 5 m with two-phase level switch (only CDV 20-600 g/h)	
4	Suction lance for 25 l tank with 2 drip pans 40 l without leakage sensor (only CDV 20-600 g/h)	
	Mechanical design	
0	Standard	
	Preset language	
DE	german	
EN	english	
FR	french	
IT	italian	
ES	spanish	
CZ	Czech	
FI	Finnish	
HU	Hungarian	
SL	Slovenian	
NL	Dutch	
RU	Russian	
	Control	
0	Basic version *)	
1	With measuring and control properties (only in connection with version inputs and outputs 1 or 3)	
2	With measuring and control properties, data logger and screen recorder (only in connection with version inputs and outputs 1 or 3)	
	Extended inputs and outputs	
0	none	
1	2 analogue inputs, freely configurable for controller output and flow rate	
2	1 analogue output, freely configurable	
3	2 analogue inputs and 1 analogue output, freely configurable	
	Communication interfaces	
0	Standard	
	Approvals	
01	CE-mark	
	Temperature monitoring	
0	without temperature monitoring	
	Hardware	
0	Standard	
	Software	
0	Standard	

* 4 contact inputs for leakage, external fault, high dosage and pause plus 3 contact outputs for operating, warning and alarm messages.
1 digital and 1 frequency input for connection of flow meters.

3 Bello Zon® Chlorine Dioxide Systems

3.7.2

Maintenance Sets for Bello Zon® CDV Chlorine Dioxide Systems

The maintenance kits contain all of the wear parts that may need to be replaced during regular system maintenance.

Maintenance sets for CDVc systems

	Order no.
Maintenance set, complete CDVc 20	1034758
Maintenance set, complete CDVc 45	1034759
Maintenance set, complete CDVc 120	1034760
Maintenance set, complete CDVc 240	1034761
Maintenance set, complete CDVc 600	1034762
Maintenance kit, complete CDVc 2000 up to delivery date 03/2011	1034763
Maintenance kit, complete CDVc 2000 from delivery date 04/2011	1048801

Maintenance sets for CDVb systems

	Order no.
Maintenance set, complete CDVb 15	1022252
Maintenance set, complete CDVb 35	1022253
Maintenance set, complete CDVb 60	1022264
Maintenance set, complete CDVb 120	1022265
Maintenance set, complete CDVb 220	1024614

Maintenance sets for CDVa systems

	Order no.
Maintenance set, complete 230 V CDVa 35	791842
Maintenance set, complete 230 V CDVa 60	791913
Maintenance set, complete 230 V CDVa 120	791915
Maintenance set, complete 230 V CDVa 220	740824
Maintenance set, complete 230 V CDVa 400	740765
Maintenance set, complete 230 V CDVa 600	740826
Maintenance set, complete 230 V CDVa 2000	1005333
Maintenance set, complete 115 V CDVa 35	791860
Maintenance set, complete 115 V CDVa 60	791914
Maintenance set, complete 115 V CDVa 120	791916
Maintenance set, complete 115 V CDVa 220	740825
Maintenance set, complete 115 V CDVa 400	740819
Maintenance set, complete 115 V CDVa 600	740827
Maintenance set, complete 115 V CDVa 2000	1005344

Additional spare parts are listed in the operation instructions for the systems.

3 Bello Zon® Chlorine Dioxide Systems

3.8

Chlorine Dioxide System Bello Zon® CDKc

Bello Zon® CDKc is a deluxe system, persuading customers with its safe handling of chemicals. 8 – 12,000 g/h chlorine dioxide. Max. flow rate at 0.2 ppm ClO₂ metering is 60,000 m³/h



Chlorine dioxide system for continuous production, metering and monitoring of chlorine dioxide with concentrated chemicals. Bello Zon® CDKc is a ready-to-use convenient system with integrated intrinsically safe pre-dilution station.

This chlorine dioxide system includes an intrinsically safe pre-dilution station for concentrated hydrochloric acid. The consumption of hydrochloric acid can therefore be adapted on site to the individual operating conditions. Savings of up to a quarter of the acid quantity are possible. The special reactor concept generates chlorine dioxide safely and simply with maximum output. Food-compatible PVDF is used instead of PVC generally used in the industry. This results in improved operating safety and reliability and improved purity of the chlorine dioxide generated. The central system controller manages the precise production of the chlorine dioxide. All parameters relevant for water treatment are recorded and logged.

The stroke lengths of ProMinent® metering pumps are monitored online. This rules out hazardous operating statuses arising from incorrect pump stroke length adjustments. The precise production of chlorine dioxide is managed by the central system control. Chlorine dioxide, chlorite, pH or ORP potential sensors DULCOTEST® are directly connected to the two mA inputs. The chlorine dioxide is monitored in the treated water and documented. The chlorine dioxide concentrations in the water can be adjusted automatically depending on the measurement by the integrated PID controller. The integrated data logger documents all status messages and measured values, which the screen writer then visualises on the clear colour display. The systems meet all the requirements of the DVGW specifications W 224 and W 624 with regard to construction and operation and are designed for operation with concentrated chemicals chlorite (24.5% NaClO₂) and acid (25-36% HCl).

Your benefits

- Cost saving through minimal acid consumption
- Cost-effective operation by the use of inexpensive concentrated output chemicals
- Efficient operation, thanks to production, metering and monitoring of ClO₂ with just one system
- Maximum operating safety and purity of the ClO₂ produced through the use of PVDF reactors
- Integrated measuring and control technology
- Perfect quality management, thanks to integrated storage of all operating parameters and measured values

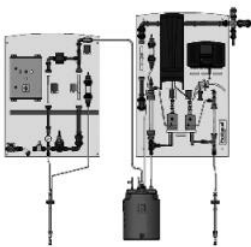

P_PMA_BEZ_0096_SW
CDKc 420 (figure shows optional configuration) ¹⁾

Technical Details

Power supply

- 100-230 V, 50/60 Hz

Inputs

- 2 freely configurable analogue inputs (0/4-20 mA)
- 7 digital inputs for monitoring
- 1 digital input for contact water meter 0.25 – 20 Hz
- 1 frequency input for water meter 10 – 10,000 Hz

Outputs

- 1 operating signal relay
- 1 alarm signal relay
- 1 warning signal relay
- Mains output for control of the bypass pump
- 1 freely configurable analogue output (0/4-20 mA)
- 1 +5 V voltage output as supply voltage for water meter with Hall sensor

Operating substances

- 24.5% sodium chlorite, purity as per EN 938
- Hydrochloric acid 25 – 36% purity according to EN 939
- Particle-free water

Degree of protection

- IP 65

Field of application

- Municipal potable water and waste water treatment
- Industrial process and cooling water

3 Bello Zon® Chlorine Dioxide Systems

Technical Data

Type ¹⁾	Chlorine dioxide dosing capacity* ¹⁾		Max. operating pressure**	Operating temp.	Connection dimensions of chlorite and acid metering pumps	Dimensions of the bypass connector
	min.-max./hour g/h	min./day g/d				
CDKc 150	8-150	56	8	10-40	6x4	25
CDKc 400	20-400	140	8	10-40	8x5	25
CDKc 900	45-900	300	8	10-40	8x5	32
CDKc 2000	100-2,000	700	5	10-40	8x5	40
CDKc 2800	140-2,800	700	5	15-40	8x5	40
CDKc 7300	365-7,300	1,750	3	15-40	DN 10	40
CDKc 12000	600-12,000	1,750	2	18-40	DN 10	40

Type ¹⁾	Dimensions*** H x W x D (mm)	Weight*** kg	Power consumption (max.) ****		Power uptake W
			230 V A	115 V A	
CDKc 150	1,380 x 880 x 320	55	0.7	1.2	130
CDKc 400	1,650 x 880 x 445	80	0.9	1.2	180
CDKc 900	1,920 x 920 x 510	95	1.4	2.5	250
CDKc 2000	1,880 x 1,320 x 570	160	2.2	3.5	410
CDKc 2800	1,880 x 1,320 x 570	160	2.2	3.5	410
CDKc 7300	2,250 x 1,850 x 460	175	5.5	6.4	640
CDKc 12000	2,250 x 1,850 x 460	180	5.5	6.4	640

* The metering figures relate to 5 or 2 bar back pressure and an ambient temperature of 20 °C. The minimum capacity/per hour is based on the fact that when the system is operating at below 5% of the nominal power, continuous metering is no longer possible, due to the correspondingly low pumping frequency of the metering pumps. When systems are not operating continuously, the reactor contents must be changed at least twice daily. The system should not, therefore, be operated below the stated minimum capacity/day.

** At 35 °C ambient temperature

*** Without bypass pump, flushing valve and water supply line

**** 230 V figure with bypass pump (CDKc 150-900), 115 V figures without bypass pump

¹⁾ **Subject to technical and design changes.**

Dimensions of the pre-dilution unit (H x W x D) for CDKc 150 - 12,000: 1,200 x 900 x 300 mm

3 Bello Zon® Chlorine Dioxide Systems

3.8.1 Identity Code Ordering System for CDKc Systems

CDKc	Capacity of ClO₂ including HCl pre-dilution and flushing assembly	
20	CDKc 150 = 150 g/h	
21	CDKc 400 = 400 g/h	
22	CDKc 900 = 900 g/h	
23	CDKc 2,000 = 2,000 g/h	
24	CDKc 2,800 = 2,800 g/h	
25	CDKc 7,300 = 7,300 g/h	
26	CDKc 12,000 = 12,000 g/h	
	Version	
P	ProMinent	
	Operating voltage	
A	230 V ±10%, 50/60 Hz (for version with bypass 04)	
B	100 – 115 V ±10%, 50/60 Hz (not available for version with bypass 04)	
	Bypass version, bypass monitoring	
02	Bypass PVC-U with float flow meter	
04	Bypass PVC-U with float flow meter and pump (VA) only with 230 V operating voltage (only with CDKc 150-900 g/h)	
	Calibrating device	
1	with calibrating device	
	Suction lance, suction fitting for chemicals	
0	none	
2	Suction lance for 200 l container, not available for CDKc 7300 and CDKc 12000	
3	Flexible suction assembly 5 m, not available for CDKc 7300 and CDKc 12000	
	Mechanical design	
0	Standard	
	Preset language	
DE	german	
EN	english	
FR	french	
IT	italian	
ES	spanish	
CZ	Czech	
FI	Finnish	
HU	Hungarian	
PL	Polish	
PT	Portuguese	
SL	Slovenian	
	Control	
0	Basic version *)	
1	With measuring and control properties (only in connection with version inputs and outputs 1 or 3)	
2	With measuring and control properties, data logger and screen recorder (only in connection with version inputs and outputs 1 or 3)	
	Extended inputs and outputs	
0	none	
1	2 analogue inputs, freely configurable for controller output and flow rate	
2	1 analogue output, freely configurable	
3	2 analogue inputs and 1 analogue output, freely configurable	
	Communication interfaces	
0	Standard	
	Approvals	
01	CE mark	
	Temperature monitoring	
0	without temperature monitoring	
	Hardware	
0	Standard	
	Software	
0	Standard	

* 4 contact inputs for leakage, external fault, high dosage and pause plus 3 contact outputs for operating, warning and alarm messages.
1 digital and 1 frequency input for connection of flow meters.

3 Bello Zon® Chlorine Dioxide Systems

3.8.2 Maintenance Kits for Bello Zon® Type CDK Chlorine Dioxide Systems

The spare parts kits include all wearing parts that need replacing in the course of regular maintenance.

	Order no.
Maintenance kit, complete 230 V CDKa 150	740740
Maintenance kit, complete 230 V CDKa 420	740743
Maintenance kit, complete 230 V CDKa 750	1000172
Maintenance kit, complete 230 V CDKa 1500	1000856
Maintenance kit, complete 230 V CDKa 6000	1004814
Maintenance kit, complete 230 V CDKa 10000	1006647
Maintenance kit, complete 115 V CDKa 150	740741
Maintenance kit, complete 115 V CDKa 420	740744
Maintenance kit, complete 115 V CDKa 750	1000173
Maintenance kit, complete 115 V CDKa 1500	1000855
Maintenance kit, complete 115 V CDKa 6000	1004815
Maintenance kit, complete CDKc 150 (type 20)	1043841
Maintenance kit, complete CDKc 170 (type 02)	1036454
Maintenance kit, complete CDKc 400 (type 21)	1043842
Maintenance kit, complete CDKc 420 (type 04)	1036455
Maintenance kit, complete CDKc 900 (type 22)	1043843
Maintenance kit, complete CDKc 900 (type 06)	1036456
Maintenance kit, complete CDKc 2000 (type 23)	1043864
Maintenance kit, complete CDKc 2100 (type 08)	1036457
Maintenance kit, complete CDKc 2800 (type 24)	1043865
Maintenance kit, complete CDKc 3000 (type 10)	1036458
Maintenance kit, complete CDKc 7500 (type 25)	1043866
Maintenance kit, complete CDKc 7500 (type 12)	1036459
Maintenance kit, complete CDKc 12000 (type 26)	1043867
Maintenance kit, complete CDKc 12000 (type 14)	1040079

Additional spare parts are listed in the operating instructions for the systems.

3 Bello Zon® Chlorine Dioxide Systems

3.9 Storage Tank Accessories

External Storage Module CDVc/CDKc

The large chlorine dioxide storage module with integrated volume compensation bag

Useful capacity 150 l

The external storage module features a volume compensation bag so that no external bleed line or neutralisation of the chlorine dioxide gas volume is needed.

The maximum permissible concentration of the ClO₂ solution is 2,000 mg/l.

Your benefits

The storage module can be connected on a project basis to the chlorine dioxide systems BelloZon® CDVc and CDKc. Make sure that the defined safety equipment (secure bypass) is also installed. Please contact our Sales Department with any project enquiries.

Field of application

The external storage module can be used in applications where more than one point of injection is needed and where a capacity of more than 120 g ClO₂ per hour is needed.

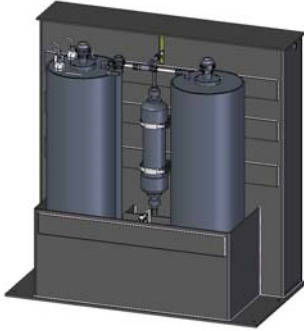

04_VM_150L



06_VM_150L

	Dimensions L x W x H (mm)	Connectors. Extraction	Filling	Order no.
Storage module 150 l for BelloZon®	1,300 x 685 x 1,290	2 x DN 32	1 x DN 25	1060153

3

3 Bello Zon® Chlorine Dioxide Systems

3.10 Bypass Line Accessories

Premixers Made of PVC

CDVb 15-120 premixers are fully integrated in the plant, provided they are ordered with the Identity Code. The premixer on the CDVb 220 can also be ordered by Identity Code but is supplied loose with the plant. On all other plants, the premixer can be ordered partly by Identity Code or partly as a separate order. The standard delivery package of the premixer includes all PVC couplings, screw hose clips and other fixing materials. On the CDVa 2000 and CDKa 1500–10000, the pre-mixer is in two parts.

Plant	Volume	Length	Connection nominal diameter	Order no.
	l	mm		
CDVb 220, CDKa 150	1.5	594	DN 25	740649
CDVa 400, CDKa 420	4.5	756	DN 25	740650
CDVa 600, CDKa 750	7.0	1,306	DN 32	740832
CDVa 2000, CDKa 1500	13.4	2x1,316	DN 40	1001000
CDKa 6000/10000	13.4	2x1,330	DN 50	1003121

Bypass Pump

Booster pumps made of cast iron (GG) or stainless steel (SS) for operation in the bypass line. Electrical version 220-230 V, 50 Hz, with integrated overload protection.

The required bypass flow should be considered when selecting a suitable bypass pump. The following flow data is recommended for the different plants:

Plant type	Bypass line	Diameter (mm)	Flow rate (m3/h)
CDV 15 – 600	DN 25	32	0.5 - 2
CDV 2,000	DN 40	50	2 - 10
CDKa 150 – 420	DN 25	32	0.5 - 2
CDKa 750	DN 32	40	1 - 3.5
CDKa 1,500	DN 40	50	1.5 - 10
CDKa 6,000 – 10,000	DN 50	63	6 - 10
CDKc 150 - 900	DN 25	32	0.5 - 2
CDKc 2,000 - 2,800	DN 40	50	2 - 10
CDKc 7,300	DN 40	50	6 - 10
CDKc 12,000	DN 40	50	10 - 15

PVC should be used as the material for the bypass. The thickness should at least correspond to the pressure range PN 10, or even better PN 16 (bar).

Technical Data

Type	Material	Connection suction/ discharge side	Pump capacity at 2 bar	Nominal rating	Nominal current	Order no.
		inch	m ³ /h	W	A	
ZHM 3	SS	RP 1"/1"	1.2	500	2.3	1051081



Caution: Do not allow pump to come into contact with ClO₂!

Accessories

	Order no.
Bracket for bypass pump	791474
Angle-seat valve PVC DN 25 for throttling the bypass pump	1001877

3 Bello Zon® Chlorine Dioxide Systems

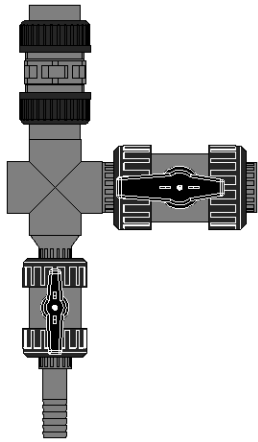

P_PMA_AC_0257_SW
Flushing assembly

Flushing Assembly

Install a flushing valve downstream of the chlorine dioxide system so that the reactor and pre-mixer can be flushed through, either for maintenance purposes or after a long system shut-down. The complete flushing equipment kit comprises a DN 20 or DN 25 PVC stopcock and a DN 15 PVC flushing valve with a hose nozzle and a DN 25 vacuum relief valve. It is already included as standard in the scope of supply of all new systems.

	Order no.
Flushing equipment PVC-U, EPDM, DN 20 for CDE	1047718
Flushing equipment PVC-U, EPDM, DN 25 for CDV, CDK	1033405

3

Bypass Pressure Gauge CDVc/CDKc

The fitting is used during commissioning to adjust the water pressure in the bypass. It is connected to the flushing valve on the flushing assembly for this purpose. The pressure measurement bypass consists of a PVC stopcock DN 15 and a diaphragm seal with manometer.

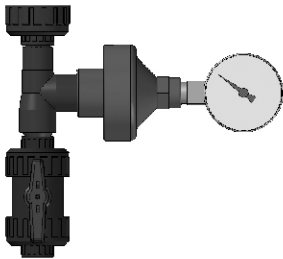

P_PMA_AC_0258_SW1

	Order no.
Bypass pressure measurement DN 20 for CDE, CDVc, CDKc	1050092

Ball-check Valve

A back pressure-resistant ball-check valve should be fitted on installations with long bypass lines, especially if the pipe slopes downwards and the point of injection is below the Bello Zon® system, as well as on installations with fluctuating back pressure.

Type	Nominal diameter	Connector	Material	Order no.
DHV-U	DN 20	G 1 1/4"	PCB	1037775
DHV-U	DN 25	G 1 1/2"	PCB	1037774
DHV 712-R	DN 40	G 2 1/4"	PCB	1000052

PVC-U Chlorine Dioxide Point of Injection

Use an immersion pipe for homogeneous distribution of the chlorine dioxide enriched bypass water in the main water supply pipe, to optimise the mixing and distribution of the chlorine dioxide. Shorten the immersion pipe on site to the required length. The scope of delivery includes a ball valve DN 25 as a shut-off valve for this purpose. The immersion pipe is installed using a DN 50 DIN flange supplied by others.

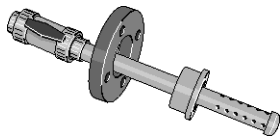

pk_7_011_2
Injection pipe from DN 100

	Order no.
Injection pipe for pipe diameters up to DN 80	1018754
Injection pipe for pipe diameters from DN 100	1018753

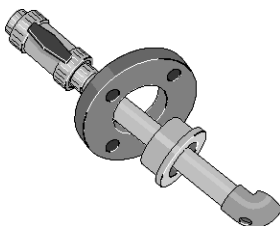

pk_7_012_2
Injection pipe to DN 80

3 Bello Zon® Chlorine Dioxide Systems

Inductive Magnetic Flow Meters

The flow meter with transducer MAG 5100 W is especially suitable for water flow measurement in the fields of ground water, potable water, waste water and sludge.

	Connection nominal diameter	Order no.
Inductive magnetic flow meter	DN 25	1048775
	DN 50	1034685
	DN 65	1034686
	DN 80	1034687
	DN 100	1034688

3 Bello Zon® Chlorine Dioxide Systems

3.11 Chemical Supply Accessories

Suction Lances and Accessories

Suction lances have a rigid construction that can be precisely adapted to the chemical tank. Suction assemblies consist of flexible suction lines.

All suction lances and suction assemblies are made of PVC with FKM seals and are fitted with a foot valve and two-stage level switch including cable and round plug. Select relevant components from the ProMinent motor-driven metering pump accessories range for system types not listed here.

	Suitable for system types	Order no.
Suction lance for connection to 5-60 litre non-reusable tank with 2 m long suction hose (6/4 mm)	CDVc 20-120, CDE 45-80	802077
Suction lance for connection to 5-60 litre non-reusable tank with 2 m long suction hose (6/4 mm)	CDLb	790650
Suction lance for connection to 5-60 litre non-reusable tank with 2 m long suction hose (8/5 mm)	CDVc 240-600, CDE 140	802078
Suction lance for connection to 200 litre drums with 3 m long suction hose (6/4 mm)	CDVc 20-120, CDE 45-80	802079
Suction lance for connection to 200 litre drums with 3 m long suction hose (6/4 mm)	CDLb	791563
Suction lance for connection to 200 litre drums with 3 m long suction hose (8/5 mm)	CDVc 240-600, CDE 140	802080
Flexible suction fitting with D55 screw cap and 5 m suction hose (6/4mm)	CDVc 20-120, CDE 45-80	1034602
Flexible suction fitting with D55 screw cap and 5 m suction hose (8/5 mm)	CDVc 240-600, CDE 140	1034644
Suction lance DN 25 PP for connection to 200 litre drums, excluding cable	CDVc 2000	1039397
Suction lance DN 25 PP for connection to 1,000 litre IBC container, excluding cable	CDVc 2000	1039399
Gas-tight suction lance for 200 litre drums with bleed valve, connection for 6/4 and 8/5 mm suction lines and connector for 6/4 mm return line	CDKc 150-2800	1036371
Gas-tight suction lance for 60-litre canister with bleed valve, connector for 6/4 and 8/5 mm suction line and connector for 6/4 mm return line	CDKc 150-2800	1030891
Flexible suction assembly with 5 m suction hose (6/4 mm) and gas-tight D55 screw cap with opening for a return line	CDKc 150-2800	1036174
Flexible suction assembly with 5 m suction hose (8/5 mm) and gas-tight D55 screw cap with opening for a return line	CDKc 150-2800	1036175

Safety Collecting Pans for Chemical Tanks

Usable capacity l	Type	Order no.
40	Without leakage monitor	791726
40	With leakage monitor	791728
70	Without leakage monitor	740309
70	With leakage monitor	740308
140	Without leakage monitor	740723
140	With leakage monitor	1003190

Scope of delivery:

- Without leakage monitor: one pan
- With leakage monitor: two pans + level switch + electronics card for Bello Zon® control (CDVa, CDVb, CDKa)

3 Bello Zon® Chlorine Dioxide Systems



Extension cable, 3-core

For 2-stage level switches, with round plug and round plug coupling.

	Cable length m	Fig.	Order no.
Extension cable, 3-core	3	pk_1_126	1005559

Calibration Free-standing Cylinder for Bello Zon® CDEa

	Order no.
Measuring cylinder, tall, 500 ml PP	790661

Leakage Monitor for CDVc and CDKc Systems

	Order no.
Level switch with litz wire 5 m	1003191

Consisting of 1 level switch to be fitted in the 40, 70 or 140 l safety drip pans without leakage monitor and connected to the control of the Bello Zon® CDVc and CDKc.

Drip Pan with Grating to Install Two 200 l Barrels

Material	Weight kg	External dimension WxDxH mm	Effective area WxD mm	Collecting volume l
Polyethylene	ca. 22	1,230 x 820 x 435	1,160 x 750	220

Meets the requirements of the German Water Resources Act (WHG) and possesses a general building supervision approval from DIBt, Berlin.

	Order no.
Drip pan with grating	1027211

Bello Zon® Acid

Component 1 for Bello Zon® chlorine dioxide production system.

	Order no.
Bello Zon® Acid 25 l	1027594
Bello Zon® Acid 200 l	950131

Bello Zon® Chlorite

Component 2 for Bello Zon® chlorine dioxide production system.

	Order no.
Bello Zon® Chlorite 10 l	1026422
Bello Zon® Chlorite 25 l	1027595
Bello Zon® Chlorite 200 l	950136

3 Bello Zon® Chlorine Dioxide Systems

3.12 Safety Accessories and Analysis

Gas detector Neon® Gas Chlorine Dioxide

The gas detector type Neon® Gas Chlorine Dioxide is designed as a compact measuring and switching unit for monitoring the ambient air for dangerous concentrations of chlorine dioxide.

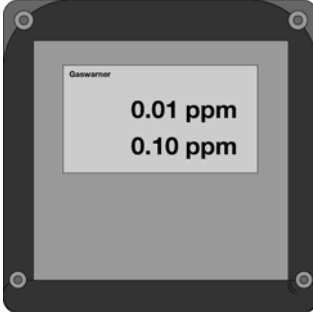

P_DV_0030_SW

Technical Data

Type	Chlorine dioxide
Warning at approx.	0.2 ppm/vol%
Alarm at approx.	1.0 ppm/vol%
Permissible ambient temperature	0...50°C
Protection class housing	IP 65
Dimensions (without PGs, without sensor) H x W x D	144 x 144 x 156 mm
Supply	85 – 265 / 50 – 60 V/Hz
Power consumption	10 W
Warm-up phase max.	150 s
"Warning" relay contact, self-resetting	250 V ; 6 A
"Alarm" relay contact, latching	250 V ; 6 A
"Horn" relay contact, latching, can be acknowledged	250 V ; 6 A
Sensor measuring principle	Electrochemical
Sensor service life (depending on ambient conditions)	1 years

Note: The sensor responds to all oxidising gases

	Order no.
Gas detector neon® ClO ₂ including 1 Sensor	1083161

* Storage sensor at 4 °C... 10 °C

Accessories and spare parts for gas warning device

	Order no.
Gas sensor support	1082466
Connecting cable 5x0.25 mm ² 10 m	1082467
Chlorine dioxide sensor 1 ppm*	1082469

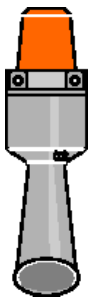

Flash light-horn

Combined horn and red warning lamp. IP 33 housing made of impact-resistant grey ABS with a clear polycarbonate dome. Connected load: 230 V AC, 50 mA.

	Order no.
Flash light-horn, red with continuous tone	1083160

Warning Label for Chlorine Dioxide System

Soft PVC film, yellow/black, 300 x 200 mm, self-adhesive.

Text	Language	Order no.
"Behälter und Geräte nicht wechselweise benutzen"	German	607320
"Never mix up chemical containers"	English	607318
"Non usare serbatoi e apparecchi alternativamente"	Italian	791886

Warning Label for Chlorine Dioxide Room

PVC film yellow/black, 200 x 80 mm

Text	Language	Order no.
"Zutritt nur für unterwiesene Personen"	German	607322
"Entry for authorised persons only"	English	607319
"Vietato l'accesso ai non addetti ai lavori"	Italian	791885

3 Bello Zon® Chlorine Dioxide Systems

Acid Fume Separator

Acid vapour separator, filled with acid-binding granules for the absorption of hydrochloric acid vapours.

	Order no.
Acid vapour separator CDKa 0.7 l	1009987
Acid vapour separator CDKc 0.13 l	1034692
Spare back of binder 0.15 l CDKc	1035854
Spare back of binder 0.7 l CDKa	1010500

Photometers DT1, DT2 and DT4

- Portable, compact photometer
- Simple operation with text support
- Safe, simple measurement of chlorine, chlorine dioxide, fluoride, chlorite, H₂O₂, bromine, ozone, pH and cyanuric acid
- Calibratable

Technical Data

Measuring ranges of the DT1B	0.05 ... 6.0 mg/l free chlorine (DPD1) +total chlorine (DPD1+3) 5 ... 200 mg/l free chlorine (high range) 0.1 ... 13.0 mg/l bromine (DPD1) 0.05 ... 11 mg/l chlorine dioxide (DPD1) 0.03 ... 4.0 mg/l ozone (DPD4) 6.5 ... 8.4 pH (phenol red) 1 ... 80 mg/l cyanuric acid
Measuring ranges of the DT2C	0.05 ... 2.0 mg/l fluoride 0.05 ... 6.0 mg/l free chlorine and total chlorine 0.05 ... 11.0 mg/l chlorine dioxide
DT4 ranges	0.03 ... 2.5 mg/l chlorite 0.05 ... 11 mg/l chlorine dioxide 0.05 ... 6 mg/l chlorine
Measuring tolerance	Dependent upon measured value and measuring method
Battery	4 AA/LR6 batteries
Permissible ambient temperature	5...40 °C
Relative humidity	30 ... 90% (non-condensing)
Material	Housing material: ABS Keypad: Polycarbonate
Dimensions L x W x H (mm)	190 x 110 x 55
Weight	0.4 kg

		Order no.
Photometer DT1B	Complete with carrying case	1039315
Photometer DT2C	Complete with carrying case	1039316
Photometer DT4B	Complete with carrying case	1039318

The standard delivery package for the photometers includes accessories, cuvettes and reagents

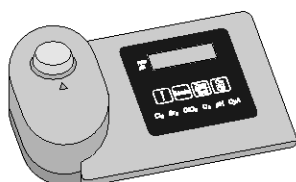

P_DT_0074_SW
Photometer

3 Bello Zon® Chlorine Dioxide Systems

Case for Chlorine Dioxide Depletion Test

The case contains the equipment needed for a ClO₂ depletion test. A photometer and the starting chemicals are also needed.

Important: Only allow trained personnel to use the case!

	Order no.
Measuring case	1042890

Consumables for Analysis

	Order no.
DPD1 tablets, 100 pieces *	1061892
DPD3 tablets, 100 pieces **	1061893
Glycine tablets, 20 pieces	1061944
Phenol red tablets 100 pieces	305532
Cyanuric acid tablets, 100 pieces	1039744
SPADNS reagent, 250 ml for fluoride detection	1010381
Calibration standard fluoride 1 mg/l, for calibration of the photometer during fluoride determination	1010382
3 pieces replacement cuvettes; round cuvettes with lid for DPD, phenol red and cyanuric acid detection (DT1, DT1B, DT4, DT4B, DT2B, DT2C)	1007566
3 pieces replacement cuvettes for fluoride detection (DT2B and DT2C)	1010396
Chlorine dioxide tablets No. 1, 250 no.	1039732
Chlorine dioxide tablets No. 2, 250 no.	1039733
Chlorine HR tablets, 100 pieces	1075056
Acidifying tablets, 100 pieces	1075057

* replaces DPD1 buffer, 15 ml (1002857) and DPD1 reagent, 15 ml (1002858)

** replaces DPD3 solution, 15 ml (1002859)

DPD reagents for measurement of excess chlorine, ozone or chlorine dioxide in the water, in conjunction with a Lovibond comparator.

	Amount	Order no.
DPD tablets no. 1	100	501319
DPD tablets no. 2	100	501320
DPD tablets no. 3	100	501321
DPD tablets no. 4	100	501322

3

4 Electrolysis Systems CHLORINSITU® and DULCO®Lyse

4.1

Electrolysis Systems CHLORINSITU®

Chlorine and sodium hydroxide are produced in-situ with electrolysis by passing an electric current through salt water.

In an **open electrolysis cell** (type CHLORINSITU® II), the electrochemical reaction takes place in a flow chamber, so that the freshly produced chlorine gas immediately reacts with the sodium hydroxide to form sodium hypochlorite. A saturated brine is used as a salt solution, which is produced in a separate salt dissolving tank from salt of a defined quality. The benefit of open electrolysis cells lies in the simple construction of the equipment, its ease of maintenance and low investment compared with **membrane electrolysis systems**. The disadvantage is the low output of salt solution, higher entrainment of chloride into the water to be treated, higher power consumption and relatively low chlorine concentrations (5 g/l FAC) in the end product.

In **membrane electrolysis**, the electrochemical reaction takes place in two electrode chambers separated by a diaphragm, so that the formation of the freshly produced chlorine gas and sodium hydroxide is physically separated. Systems of type CHLORINSITU® III and CHLORINSITU® III Compact bring the reaction mixtures of both electrode chambers together again after the electrochemical reaction to produce a stock solution of sodium hypochlorite (25 g/l FAC), which can be stored temporarily and metered as needed.

With systems of type CHLORINSITU® IV Compact and CHLORINSITU® V, the highly pure chlorine gas is fed into the water to be treated through an injector and under constant vacuum, where it dissolves as hypochlorous acid. In systems of type CHLORINSITU® V Plus, any excess chlorine gas produced is combined with the sodium hydroxide, as in the CHLORINSITU® III system, to form sodium hypochlorite and is then stored temporarily. The systems therefore only need to be designed for average chlorine demand, as peaks of capacity can be compensated for from the sodium hypochlorite temporary storage tank. In all systems of types CHLORINSITU® IV Compact, CHLORINSITU® V and CHLORINSITU® V Plus, the sodium hydroxide produced during electrolysis is stored temporarily and metered in, as required, to correct the pH value.

The benefit of membrane systems lies in their excellent efficiency (85 % brine output) and minimal entrainment of chloride compared with open electrolysis cells. With systems of type CHLORINSITU® V and CHLORINSITU® V Plus, the entrainment of chloride and chlorate from the electrolysis cell into the water to be treated can be avoided completely. In membrane cell electrolysis systems for producing sodium hypochlorite, the higher output results in solutions with a significantly higher chlorine content than is the case with open electrolysis cells.

- Disinfection from natural sodium chloride
- No handling of hazardous chemicals
- High-purity product, thanks to production in situ and short temporary storage periods
- The chlorine gas is generated under a constant vacuum, absolutely reliably and with maximum operating safety, thanks to the units being designed as vacuum systems
- Chlorine generation and pH correction with one system (CHLORINSITU® IV Compact, CHLORINSITU® V and CHLORINSITU® V Plus)
- Improved working conditions for operating personnel
- No risk of confusing dangerous chemical tanks

4 Electrolysis Systems CHLORINSITU® and DULCO®Lyse

4.2 Performance Overview

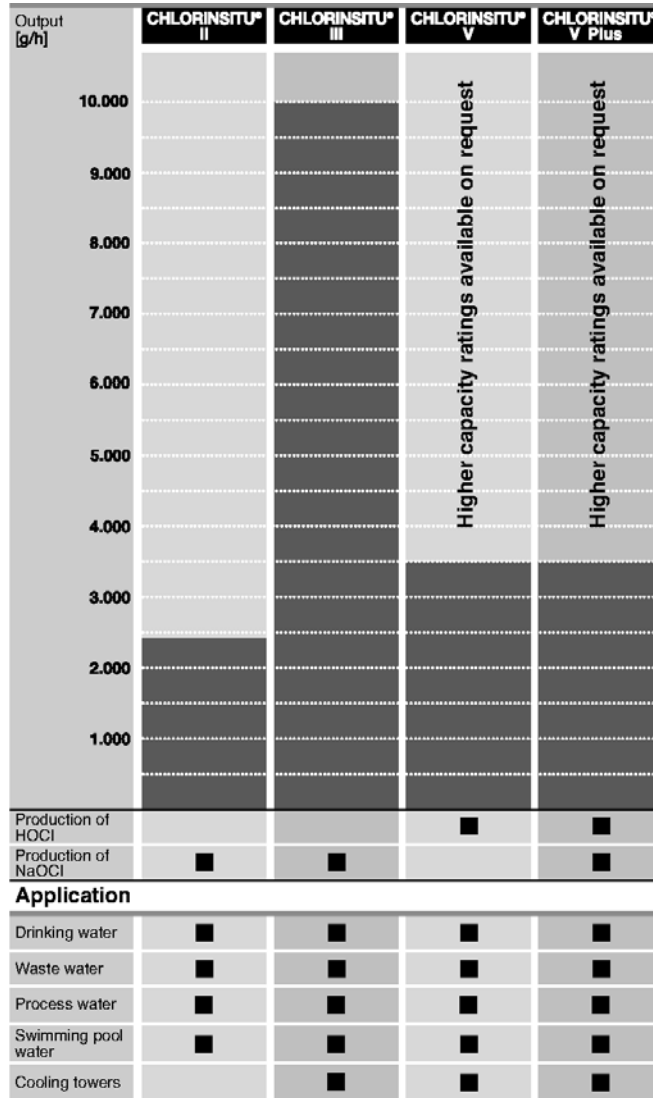

P_PMA_EL_0008_SW

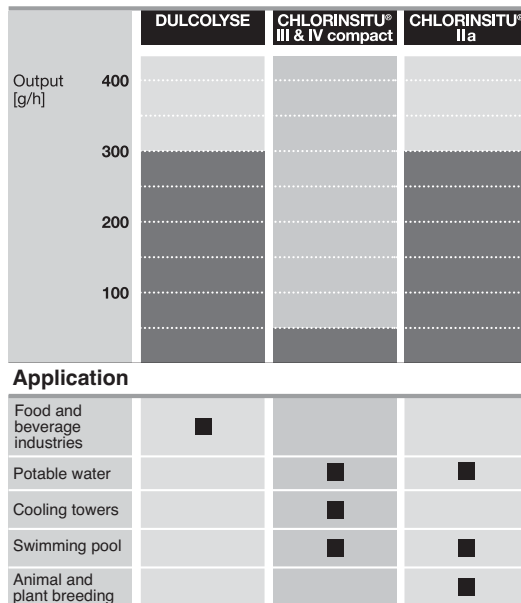

P_PMA_EL_0044_SW

Note: larger systems available on request

4 Electrolysis Systems CHLORINSITU® and DULCO®Lyse

4.3 Questionnaire on the Design of an Electrolysis System

Use of the electrolysis plant:

- for disinfection of
 - Drinking water
 - Industrial water
 - Cooling water
 - Swimming pool water
 - _____

Water values:

- | | | | |
|---------------------------------|-----------------------------------|---|--|
| Max. water flow rate | _____ m ³ /h | Maximum water pressure | _____ bar |
| Water flow rate | <input type="checkbox"/> constant | <input type="checkbox"/> fluctuating from | _____ m ³ /h to _____ m ³ /h |
| pH value | _____ | Iron (Fe ²⁺) | _____ mg/l |
| Temperature | _____ °C | Manganese (Mn ²⁺) | _____ mg/l |
| Solid fraction | _____ mg/l | Nitrite (NO ₂ ⁻) | _____ mg/l |
| Acid capacity K _{94,3} | _____ mmol/l | Sulphide (S ²⁻) | _____ mg/l |
| Total hardness | _____ mmol/l | TOC (total organic carbon) | _____ mg/l |
| Total hardness | _____ °dH | Ammonia | _____ mg/l |

Response time to application:

_____ m³ volume reaction tank or _____ minutes residence time in entire system.

Type of metering:

- constant
- flow-proportional
- depending on measured value

Desired dosing rate: _____ mg/l

Disinfection method used up to now:

Consumption of disinfectant up to now: _____ kg/week

Other requirements:

4 Electrolysis Systems CHLORINSITU® and DULCO®Lyse

4.4

Electrolysis system CHLORINSITU® IIa

Electrolysis system CHLORINSITU® IIa with open cell electrolysis: improved efficiency through innovative design.

Output of 30 – 300 g/h sodium hypochlorite

CHLORINSITU® IIa is a compact on-site electrolysis system for the production of a low-chlorate hypochlorite solution from sodium chloride and electrical energy. A key advantage is its simple process management and excellent system safety through integral ventilation and bleeding.



NEW

The new CHLORINSITU® IIa combines the proven and durable design of the open electrolysis cell with an innovative design. An exceptional quality of hypochlorite solution is achieved, while the salt and power consumption could be decreased.

The chlorate content of the product is significantly below the limit value specified in EN 901.

All relevant system components are accommodated in a compact and space-saving housing. Integral hydrogen discharge enables the system to be installed without any need for specific ventilation requirements for the installation place (no ATEX).

The system is immediately ready for use, thanks to the plug-and-play concept. Operation of the electrolysis system has been consciously kept simple.

Available scope of delivery:

- Corrosion-proof housing with ventilation fan
- Control with multicoloured touch panel
- Remote maintenance module
- Salt dissolving tanks outside of the housing
- Integrated product tank with diaphragm metering pump for metering the chlorine solution
- Integrated softener

Your benefits

- Durable design, transparent technology
- Low-chlorate product (below the EN 901 limit value)
- High output
- Excellent safety
- Minimal space requirement
- Minimal maintenance work and ease of operation

Field of application

- Potable water
- Swimming pools
- Horticulture and animal breeding



CHLORINSITU IIa

4 Electrolysis Systems CHLORINSITU® and DULCO®Lyse

4.4.1 Identity code ordering system for electrolysis systems CHLORINSITU® IIa

Clia	Type	Capacity		
		g/h		
	0030	30		
	0060	60		
	0120	120		
	0180	180		
	0240	240		
	0300	300		
Design				
	P	ProMinent		
	S	Non-standard		
Mechanical design				
	0	Standard		
	M	modified		
Electrical design				
	0	230 V, 50/60 Hz		
	1	115 V, 50/60 Hz (UL/MET, CSA)		
Softener				
	0	none		
	1	with		
Chlorine pump				
	0	none		
	1	with		
Communication interfaces				
	0	none		
	1	Remote Engineer		
Additional options				
	0	None		
Pre-set language				
	DE	German		
	EN	English		
	FR	French		
	ES	Spanish		
	IT	Italian		



Accessories

External product tank

	Order no.
Tank, PE-black 250 l	1023176
Tank, PE-black 500 l	792002
Tank, PE black 1,000 l	1010912
Tank, PE black 1,500 l	1060976

Collecting pan for product tank

	Order no.
Collecting pan for product tank 250 l, PE black	1010889
Collecting pan for product tank 500 l, PE black	1010890
Collecting pan for product tank 1,000 l, PE black	740726
Collecting pan for product tank 1,500 l, PE black	1060981

Liquid level monitoring with two level switches

	Order no.
Liquid level monitoring with two level switches for external product tank (PVDF, including 5 m cable)	1034700

4 Electrolysis Systems CHLORINSITU® and DULCO®Lyse

4.5

Electrolysis System CHLORINSITU® II

Output of 400 – 2,400 g/h sodium hypochlorite



Electrolysis system CHLORINSITU® II: Robust, safe and economical system for applications where entrainment of sodium chloride into the water being treated is not a problem.

Electrolysis systems of the type CHLORINSITU® II generate hypochlorite solution with a concentration of 5 g/l. A saturated solution of sodium chloride is produced in a salt dissolving tank, included in the scope of delivery for this purpose, which, after appropriate dilution, is electrolysed in an open tubular cell. The resulting solution is collected in a storage tank and, from there, metered according to requirements using separate metering pumps. Due to its moderate pH value of 8.5 – 9, it affects the pH of the treated water significantly less than if conventional sodium-calcium hypochlorite (pH of 12 – 13.5) were used. Much less acid is used to adjust the pH value, enabling savings of up to 80 %. The hydrogen always produced during electrolysis is diluted with fresh air through an ATEX 95-approved fan and discharged safely. Both the salt-dissolving and diluting water comes from a softener unit integrated in the system, preventing the formation of lime deposits and ensuring the long service life of the electrolytic cell. There is therefore no need for acid purification. Electrolysis systems of type CHLORINSITU® II are especially suitable for applications where a robust and clearly laid out technology is required and where the entrainment of residual sodium chloride into the water being treated is not a problem.

Your benefits

- Robust, simple technology
- Safe system control with remote diagnosis by Remote Control Engineer
- Cost-effective operation thanks to the use of sodium chloride as an inexpensive raw material and lower chemical consumption for pH adjustment
- Compact, space-saving design
- Improved working conditions for operating personnel
- No risk of confusing hazardous chemicals

Technical Details

- Modern PLC with large illuminated display
- Integrated Remote Control Engineer for remote diagnosis and troubleshooting

Field of application

- Potable water
- Waste water
- Process water
- Swimming pool water

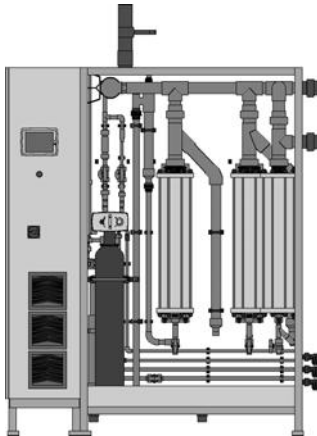

P_PMA_EL_0003_SW

4

4 Electrolysis Systems CHLORINSITU® and DULCO®Lyse

Technical Data

Power supply 3 x 400 V (> 200 g/h) (V AC/3P/N/PE/50 Hz)

Type/output	Fuse	Power uptake	Max. salt consumption	Max. consumption of process water	Product outlet H	Dimensions L x W x H (mm)	Brine tank	Recommended capacity storage tank
g/h	A	kW	kg/d	l/h	mm		l	l
400	3 x 16	3.40	32	80	1,589	1,250 x 600 x 2,000	200	2,000
500	3 x 20	4.15	40	100	1,589	1,250 x 600 x 2,000	380	2,500
600	3 x 25	4.90	48	120	1,589	1,250 x 600 x 2,000	380	3,000
800	3 x 35	6.40	65	160	1,589	1,250 x 600 x 2,000	380	3,500
1,000	3 x 35	7.90	80	200	1,589	1,250 x 600 x 2,000	520	4,500
1,200	3 x 50	9.40	95	240	1,589	1,250 x 600 x 2,000	520	5,500
1,400	3 x 50	10.90	110	280	1,589	1,250 x 600 x 2,000	520	6,000
1,600	3 x 63	12.40	130	320	1,589	1,250 x 600 x 2,000	760	7,000
1,800	3 x 63	13.90	155	360	1,589	1,650 x 600 x 2,000	760	8,000
2,000	3 x 63	15.40	175	400	1,589	1,650 x 600 x 2,000	760	9,000
2,200	3 x 80	16.90	190	440	1,589	1,650 x 600 x 2,000	760	10,000
2,400	3 x 80	18.40	210	480	1,589	1,650 x 600 x 2,000	760	11,000

Scope of delivery:

Electrolysis systems of type Chlorinsitu® II are mounted ready-wired with a PLC on a powder-coated stainless steel frame in the control cabinet. They include a Remote Control Engineer for remote diagnosis and troubleshooting, integrated water softener system, open tubular cells, ATEX 95-compliant bleed system and separate salt dissolving tanks and level monitoring unit. The system also includes liquid level sensors for monitoring the storage tank to be set up on site for sodium-calcium hypochlorite. A duplex water softener is fitted as standard for systems producing more than 1,800 g/h. Automatic monitoring of water hardness downstream of the softening system can be offered as an option.

Note:

Electrolysis systems of type CHLORINSITU® II, III, V and V Plus are offered and planned to meet customer specifications. This is true both for the system documentation and the subsequent supply of spare parts and maintenance.

4 Electrolysis Systems CHLORINSITU® and DULCO®Lyse

4.6 Electrolysis System CHLORINSITU® III



Output of 100 – 10,000 g/h sodium hypochlorite

Ultra-pure or low-chloride and low-chlorate sodium-calcium hypochlorite requires specialist system technology. The electrolysis system CHLORINSITU® III is the solution. Can be used for potable water, waste water, process water, swimming pool water and in cooling towers.

Electrolysis systems of type CHLORINSITU® III generate sodium hypochlorite with a concentration of approximately 25 g/l with minimal entrainment of sodium chloride (85 % output) from the membrane cell into the finished product. A saturated solution of sodium chloride is produced in a salt-dissolving tank, included in the scope of delivery, and this solution is then electrolysed in a membrane cell. Sodium hydroxide and hydrogen are produced in the cathode chamber while ultra-pure active chlorine and a diluted residual brine are produced in the anode chamber, separated by the membrane from the cathode chamber. The resulting active chlorine is bound to the sodium hydroxide through an injector under constant vacuum and is collected as sodium hypochlorite in a product tank. The vacuum is kept constant by a frequency-controlled circulation pump. This creates less mechanical stress on the membrane in the electrolysis cell and in other parts of the system. The complete sodium hypochlorite solution can be metered, as required, by separate metering pumps. Due to its moderate pH value of 9.5 – 10, it affects the pH of the treated water significantly less than if conventional sodium-calcium hypochlorite (pH 12 – 13.5) were used. Much less acid is used to adjust the pH value, enabling savings of up to 70 %. The hydrogen always produced during electrolysis is diluted with fresh air through an ATEX 95-approved fan and is discharged safely. The salt-dissolving water comes from a softener integrated in the system, preventing the formation of lime deposits and ensuring the long service life of the membrane cell. The efficiency of the electrolysis is constantly monitored by various flow meters, the addition of water depending on the sodium hydroxide production and a dynamic level control in the product tank.

Your benefits

- Sodium hypochlorite solution low in chloride and chlorate with a high chlorine concentration (25 g/l FAC)
- Minimal acid consumption for pH correction, enabling savings of up to 70 %
- Safe system control with remote diagnosis by Remote Control Engineer
- Excellent service life of the membrane cells, thanks to a constant vacuum
- A frequency-controlled circulation pump maintains the vacuum constant in the enclosed anode area
- Maximum operating safety due to their design as negative pressure systems
- Dynamic level control in the product tank ensures optimised chlorine production
- Active process control of production by largely internal measuring and control technology
- Cost-effective operation thanks to the use of sodium chloride as an inexpensive raw material and lower chemical consumption for pH adjustment
- Robust, simple technology
- Compact, space-saving design

Technical Details

- Modern PLC with large illuminated display
- Integrated Remote Control Engineer for remote diagnosis and troubleshooting
- Storage tank for multiple points of injection

Field of application

- Potable water
- Waste water
- Process water
- Swimming pool water
- Cooling tower

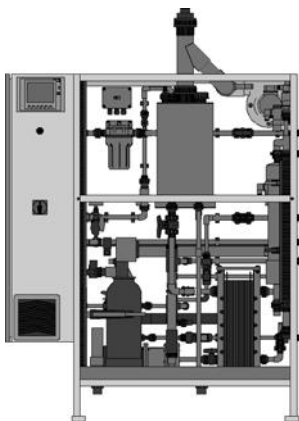

P_PMA_EL_0004_SW

4

4 Electrolysis Systems CHLORINSITU® and DULCO®Lyse

Technical Data

Power supply 3 x 400 V (VAC/3P/N/PE/50 Hz)

Type/ output	Fuse	Power uptake	Max. salt consumption	Max. consumption of process water	Max. consumption of cooling water	Dimensions L x W x H (mm)	Brine tank	Recommended capacity storage tank
g/h	A	kW	kg/d	l/h	l/h		l	l
100	3 x 16	1.10	5	4	80	1,250 x 600 x 1,550	130	200
200	3 x 16	1.50	10	8	80	1,250 x 600 x 1,550	130	300
300	3 x 16	1.90	15	12	100	1,250 x 600 x 1,550	200	400
400	3 x 16	2.30	20	16	100	1,250 x 600 x 1,550	200	500
500	3 x 16	2.70	25	20	125	1,250 x 600 x 1,550	200	600
600	3 x 20	3.10	30	24	125	1,650 x 600 x 2,000	380	700
750	3 x 25	3.70	35	30	150	1,650 x 600 x 2,000	380	800
1,000	3 x 25	4.70	50	40	150	1,650 x 600 x 2,000	380	1,200
1,250	3 x 35	5.70	60	50	150	1,650 x 600 x 2,000	380	1,500
1,500	3 x 35	6.70	70	60	180	1,650 x 600 x 2,000	380	1,700
1,750	3 x 35	7.70	80	70	180	1,650 x 600 x 2,000	380	2,000
2,000	3 x 50	8.70	100	80	200	1,750 x 1,200 x 2,000	520	2,200
2,500	3 x 63	10.70	125	100	250	1,750 x 1,200 x 2,000	520	3,000
3,000	3 x 63	12.70	150	120	300	1,750 x 1,200 x 2,000	520	3,300
3,500	3 x 80	14.70	175	140	350	1,750 x 1,200 x 2,000	520	4,000
5,000	3 x 90	20.70	250	200	500	3,100 x 1,800 x 2,070	1,180	5,800
7,000	3 x 100	29.40	350	280	700	3,100 x 1,800 x 2,070	1,180	6,000
8,500	3 x 130	35.70	425	340	850	4,300 x 1,800 x 2,070	1,180	7,500
10,000	3 x 160	40.70	500	400	1,000	4,300 x 1,800 x 2,070	1,180	11,000

Scope of delivery:

Electrolysis systems of type CHLORINSITU® III are mounted ready-wired with a PLC Programmable Logic Controller on a powder-coated stainless steel frame in the control cabinet. They include a Remote Control Engineer for remote diagnosis and troubleshooting, integrated water softener system, diaphragm electrolysis cells, ATEX 95-compliant bleed system and separate salt dissolving tanks and level monitoring unit. Dynamic level control to monitor the storage tank to be provided on site for sodium hypochlorite. A chlorine gas warning unit and automatic monitoring of water hardness downstream of the softening system come as standard with systems producing more than 600 g/h.

Note:

Electrolysis systems of type CHLORINSITU® II, III, V and V Plus are offered and planned to meet customer specifications. This is true both for the system documentation and the subsequent supply of spare parts and maintenance.

4 Electrolysis Systems CHLORINSITU® and DULCO®Lyse

4.7 Electrolysis Systems CHLORINSITU® III Compact and IV Compact

4.7.1 Electrolysis System CHLORINSITU® III Compact

From cooking salt chlorine, hydrogen and sodium hydroxide are made. Directly on site.

Output of 25 – 50 g/h sodium hypochlorite



Generation of sodium hypochlorite in smaller amounts for smaller swimming pools: Electrolysis system CHLORINSITU® III Compact.

Electrolysis systems of type CHLORINSITU® III Compact produce a disinfectant based on active chlorine. A saturated solution of sodium chloride is produced in a salt dissolving tank, included in the scope of delivery, and this solution is then electrolysed in a diaphragm cell. Sodium hydroxide and hydrogen are produced in the cathode chamber while ultra-pure active chlorine and a diluted residual brine are produced in the anode chamber, separated by the diaphragm from the cathode chamber. The active chlorine produced reacts in the reactor with the sodium hydroxide to form sodium hypochlorite with a concentration of approx. 25 g/l FAC. The hydrogen generated is discharged to the fresh air through a bleed line. The salt-dissolving water comes from a softener integrated in the system, thereby preventing the formation of lime deposits and ensuring the long service life of the electrolytic cell. Electrolysis systems of type CHLORINSITU® III Compact are especially suitable for use with smaller swimming pools in residential properties and hotels (indoor pools with a total circulation capacity of up to 40 m³/hour, chlorinated in accordance with the DIN standard).

Your benefits

- Sodium hypochlorite solution low in chloride and chlorate with a high chlorine concentration (25 g/l FAC)
- Minimal acid consumption for pH correction, making savings of up to 70 % possible
- Cost-effective operation thanks to the use of sodium chloride as an inexpensive raw material and minimal chemical consumption for pH adjustment
- Robust, simple technology
- Compact space-saving design, ready mounted on a wall panel

Technical Details

- The integrated microprocessor controller digitally indicates the current output and monitors all key functions.
- All operating and error messages are shown in plain text on the clear display.
- The output can be controlled manually, automatically (controller option) or externally.
- Optional integrated chlorine and pH control

Field of application

- Swimming pool
- Potable water
- Cooling tower

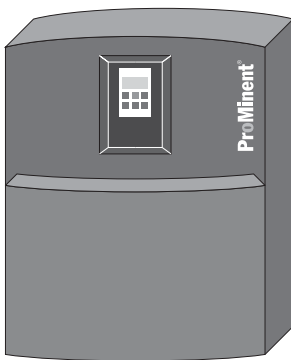

P_PMA_EL_0041_SW

4 Electrolysis Systems CHLORINSITU® and DULCO®Lyse

Technical Data

Power supply 1 x 230 Volt (VAC/1P/N/PE/50 Hz)

Type/ output	Power uptake	Max. salt consumption	Max. consumption of process water	Dimensions L x W x H (mm)	Brine tank
g/h	kW	g/h	l/h		l
25	0.11	65	1.5	590 x 355 x 650	130
50	0.22	130	3	590 x 355 x 650	130

Scope of delivery:

Electrolysis systems of type CHLORINSITU® III Compact are ready mounted and wired for use on a wall panel. Chlorine electrolysis system with integrated microprocessor control and softener system. They include a diaphragm electrolysis cell, separate salt dissolving tank with level monitor and a level control for a storage tank (tank not included with the scope of delivery). A storage tank is also required as well as a metering pump for each point of injection (pump not included in the scope of delivery). Only a chlorine and pH control can be integrated as an option. The measuring and control technology then has to be offered separately for several pools.

	Order no.
CHLORINSITU® III Compact 25	1041399
CHLORINSITU® III Compact 50	1041401
CHLORINSITU® III Compact 25 with integrated chlorine and pH controller	1041400
CHLORINSITU® III Compact 50 with integrated chlorine and pH controller	1041402

4

Spare parts and maintenance kits

Important note: Both the sensors and the metering pump(s) have to be maintained on systems with pH and/or chlorine control.

	Type	Order no.
Annual maintenance set	CHLORINSITU® III Compact 25	1041407
Annual maintenance set	CHLORINSITU® III Compact 50	1041409
3-yearly maintenance set	CHLORINSITU® III Compact 25	1041408
3-yearly maintenance set	CHLORINSITU® III Compact 50	1041410
Membrane cell	CHLORINSITU® III Compact 25	1041419
Membrane cell	CHLORINSITU® III Compact 50	1041420
Spare parts kit	CHLORINSITU® III Compact 25/50	1045233

4 Electrolysis Systems CHLORINSITU® and DULCO®Lyse

4.7.2

Electrolysis System CHLORINSITU® IV Compact

From cooking salt chlorine, hydrogen and sodium hydroxide are made. Directly on site.

Output of 25 – 50 g/h ultra-pure active chlorine



Generate ultra-pure chlorine gas using the vacuum method with electrolysis system CHLORINSITU® IV Compact. Cost-effective, robust and compact.

Electrolysis systems of type CHLORINSITU® IV Compact generate ultra-pure chlorine gas in a vacuum process. A saturated solution of sodium chloride is produced in a salt-dissolving tank, included in the scope of delivery, and this solution is then electrolysed in a diaphragm cell. Sodium hydroxide and hydrogen are produced in the cathode chamber while ultra-pure chlorine gas and dilute residual brine are produced in the anode chamber, separated by the diaphragm from the cathode chamber. The resulting chlorine gas is suctioned off through an injector integrated in the system and dissolved as hypochlorous acid in the water being treated. The hydrogen generated is discharged to the fresh air through a bleed line. The sodium hydroxide is disposed of or optionally used by a metering pump integrated in the system to correct the pH of the water being treated. The salt dissolving water comes from a softener integrated in the system, thereby preventing the formation of lime deposits and ensuring the long service life of the electrolytic cell. Electrolysis systems of type CHLORINSITU® IV Compact are especially suitable for use with smaller swimming pools in residential properties and hotels (indoor pools with a total circulation capacity of up to 25 m³/hour, chlorinated in accordance with the DIN standard).

Your benefits

- Chlorination and pH value adjustment in a single system
- Production and metering of ultra-pure hypochlorous acid
- Cost-effective operation thanks to the use of sodium chloride as an inexpensive raw material and no consumption of chemicals for pH correction
- Safe vacuum system technology
- Robust, simple technology
- Compact space-saving design, ready mounted on a wall panel

Technical Details

- The integrated microprocessor controller digitally indicates the current output and monitors all key functions.
- All operating and error messages are shown in plain text on the clear display.
- The output can be controlled manually, automatically (controller option) or externally.
- Optional integrated chlorine and pH control

Field of application

- Swimming pool
- Potable water
- Cooling tower

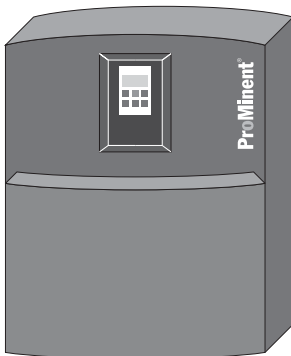

P_PMA_EL_0041_SW

4 Electrolysis Systems CHLORINSITU® and DULCO®Lyse

Technical Data

Power supply 1 x 230 Volt (VAC/1P/N/PE/50 Hz)

Type/ output g/h	Power uptake kW	Max. salt consumption g/h	Max. consumption of process water l/h	Dimensions L x W x H (mm)	Brine tank l
25	0.11	65	1.5	590 x 355 x 650	130
50	0.22	130	3	590 x 355 x 650	130

Scope of delivery:

Electrolysis systems of type CHLORINSITU® IV Compact are ready mounted and wired for use on a wall panel. Chlorine electrolysis system with integrated microprocessor control and water softening system, diaphragm electrolysis cell with negative pressure monitoring, separate salt dissolving tanks with level control, integrated injector and integral feeder assembly for sodium hydroxide (optional). A booster pump is also needed (not included in the scope of delivery) for the single possible point of injection. A chlorine and pH control can be integrated as an option. Several pools cannot be fed from one Chlorinsitu® IV Compact system.

	Order no.
CHLORINSITU® IV Compact 25	1036461
CHLORINSITU® IV compact 25 with pH correction	1036462
CHLORINSITU® IV Compact 25 with integrated chlorine and pH controller	1041405
CHLORINSITU® IV Compact 25 with integral pH and chlorine controller and pH correction	1041403
CHLORINSITU® IV Compact 50	1036463
CHLORINSITU® IV Compact 50 with pH correction	1036464
CHLORINSITU® IV Compact 50 with integrated chlorine and pH controller	1041406
CHLORINSITU® IV Compact 50 with integral pH and chlorine controller and pH correction	1041404

Spare parts and maintenance kits

Important note: Both the sensors and the metering pump(s) have to be maintained on systems with pH and/or chlorine control.

	Type	Order no.
Annual maintenance set	CHLORINSITU® IV Compact 25	1041415
Annual maintenance set	CHLORINSITU® IV Compact 25 with pH correction	1043267
Annual maintenance set	CHLORINSITU® IV Compact 50	1041417
Annual maintenance set	CHLORINSITU® IV Compact 50 with pH correction	1043269
3-yearly maintenance set	CHLORINSITU® IV Compact 25	1041416
3-yearly maintenance set	CHLORINSITU® IV Compact 25 with pH correction	1043268
3-yearly maintenance set	CHLORINSITU® IV Compact 50	1041418
3-yearly maintenance set	CHLORINSITU® IV Compact 50 with pH correction	1043270
Membrane cell	CHLORINSITU® IV Compact 25	1041419
Membrane cell	CHLORINSITU® IV Compact 50	1041420
Spare parts set	CHLORINSITU® IV Compact 25/50	1045232

4 Electrolysis Systems CHLORINSITU® and DULCO®Lyse

4.8

Electrolysis System CHLORINSITU® V

From cooking salt chlorine, hydrogen and sodium hydroxide are made. Directly on site.

Output of 100 – 3,500 g/h pure hypochlorous acid



Ultra-pure active chlorine gas is generated in a vacuum process using the electrolysis system CHLORINSITU® V. Suited to applications for metering hypochlorous acid and simultaneously correcting the pH value.

Electrolysis systems of type CHLORINSITU® V generate pure chlorine gas in a vacuum process. A saturated solution of sodium chloride is produced in a salt-dissolving tank, included in the scope of delivery, and this solution is then electrolysed in a diaphragm cell. Chloride-free sodium hydroxide and hydrogen are produced in the cathode chamber, while ultra-pure chlorine gas and dilute residual brine are produced in the anode chamber, separated by the diaphragm from the cathode chamber. The chlorine gas produced is suctioned off through an injector (contained in the scope of delivery) and fully dissolved as hypochlorous acid in the water being treated (through a bypass). The superchlorinated water is then distributed throughout the various pools via one or more proportionately controllable motor driven ball valves. The vacuum is kept stable by a single frequency-controlled booster pump. This permits significant savings in terms of energy. The chloride-free sodium hydroxide is stored temporarily and can be used for pH value correction. A standard diaphragm metering pump is first used to correct the base (pH 6.8 – 7) of the superchlorinated water. The fine correction of the pH value is provided via additional alkali metering pumps for each circuit or point of injection. The hydrogen produced is diluted with fresh air through an ATEX 95-approved fan and discharged safely. The diluted residual brine is fully discarded. To achieve this, the diluted brine is strongly diluted with softened water, neutralised by the addition of sodium hydroxide and disposed of in the sewer. All residual chloride and chlorate are thus disposed of and are not mixed with the process water. Electrolysis systems of type CHLORINSITU® V can thus be compared with pure chlorine gas in terms of their oxidation strength and chloride / chlorate content in the process water. The salt-dissolving water comes from a softener integrated in the system, preventing the formation of lime deposits and ensuring the long service life of the diaphragm cell. The efficiency of electrolysis is constantly monitored by various flow meters, the addition of water depending on the sodium hydroxide production and the base pH correction.

Your benefits

- Chlorination and pH adjustment with a single system
- Exceedingly low chloride and chlorate content
- Production and metering of high-purity hypochlorous acid without temporary storage
- Safe system control with remote diagnosis by Remote Control Engineer
- Excellent service life of the membrane cells, thanks to a constant vacuum
- A frequency-controlled circulation pump maintains the vacuum constant in the enclosed anode area
- Maximum operating safety due to their design as negative pressure systems
- Active process control of production by largely internal measuring and control technology
- Cost-effective operation thanks to the use of sodium chloride as an inexpensive raw material and no consumption of chemicals for pH correction
- Complete disposal of the diluted brine, nothing is fed back into the process water being treated
- Comparable with pure chlorine gas in terms of oxidation strength and chloride / chlorate content in the process water
- Robust technology
- Compact, space-saving design

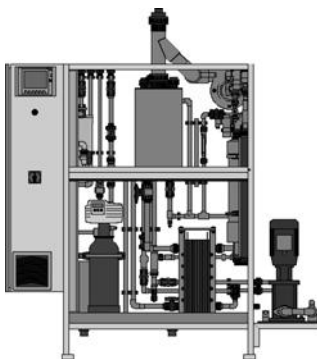

P_PMA_EL_0013_SW

Technical Details

- Modern PLC with large illuminated display
- Integrated Remote Control Engineer for remote diagnosis and troubleshooting
- Chlorine metering and pH value correction controlled via contact inputs
- Analogue input (optional)
- MODBUS or PROFIBUS® (optional)
- Several points of injection (optional)
- Multiple booster pumps (optional) can be used for different water qualities (e.g. brine and freshwater pools)

Field of application

- Potable water
- Waste water
- Process water
- Swimming pool water
- Cooling tower

4 Electrolysis Systems CHLORINSITU® and DULCO®Lyse

Technical Data

Power supply 3 x 400 V (VAC/3P/N/PE/50 Hz)

Type/output	Fuse	Power uptake	Max. salt consumption	Max. consumption of process water	Consumption of cooling water (external)	Dimensions L x W x H (mm)	Brine tank
g/h	A	kW	kg/d	l/h	l/h		l
100	3 x 16	1.10	5	60	–	1,655 x 600 x 1,550	130
200	3 x 16	1.50	10	60	–	1,655 x 600 x 1,550	130
300	3 x 16	1.90	15	60	–	1,655 x 600 x 1,550	200
400	3 x 16	2.30	20	60	–	1,655 x 600 x 1,550	200
500	3 x 16	2.70	25	60	–	1,655 x 600 x 1,550	200
600	3 x 20	3.10	30	90	–	1,950 x 600 x 2,000	380
750	3 x 25	3.70	35	90	–	1,950 x 600 x 2,000	380
1,000	3 x 25	4.70	50	90	–	1,950 x 600 x 2,000	380
1,250	3 x 35	5.70	60	90	–	1,950 x 600 x 2,000	380
1,500	3 x 35	6.70	70	90	–	1,950 x 600 x 2,000	380
1,750	3 x 35	7.70	80	90	–	1,950 x 600 x 2,000	380
2,000	3 x 50	8.70	100	175	200	1,750 x 1,200 x 2,000	520
2,500	3 x 63	10.70	150	175	250	1,750 x 1,200 x 2,000	520
3,000	3 x 63	12.70	175	175	300	1,750 x 1,200 x 2,000	520
3,500	3 x 80	14.70	175	175	350	1,750 x 1,200 x 2,000	520

Capacities > 3,500 g/h upon request

Scope of delivery:

Electrolysis systems of type CHLORINSITU® V are ready mounted, wired for use, on a powder coated stainless steel frame with a Programmable Logic Controller (PLC) in the control cabinet, Remote Control Engineer for remote diagnosis and troubleshooting, integral water softening unit, diaphragm electrolysis cells, ATEX-95-compliant bleed system and separate salt dissolving tank with level monitoring. The scope of delivery also includes a frequency-controlled central injector system matched to the system to meter active chlorine and sodium hydroxide for pH correction and a single booster pump. A chlorine gas detector unit and automatic monitoring of water hardness downstream of the softening system come as standard with systems producing more than 600 g/h.

Note:

Electrolysis systems of type CHLORINSITU® II, III, V and V Plus are offered and planned to meet customer specifications. This is true both for the system documentation and the subsequent supply of spare parts and maintenance.

4 Electrolysis Systems CHLORINSITU® and DULCO®Lyse

4.9

Electrolysis System CHLORINSITU® V Plus

From cooking salt chlorine, hydrogen and sodium hydroxide are made. Directly on site.

Output of 100 – 3,500 g/h ultra-pure hypochlorous acid



Chlorine gas in the vacuum process PLUS production of sodium hypochlorite solution with the electrolysis system CHLORINSITU® V Plus. Chlorination and pH value adjustment from a single system.

Electrolysis systems of type CHLORINSITU® V Plus generate ultra-pure chlorine gas combined with a sodium hypochlorite solution in a vacuum process. A saturated solution of sodium chloride is produced in a salt-dissolving tank, included in the scope of delivery, and this solution is then electrolysed in a diaphragm cell. Chloride-free sodium hydroxide and hydrogen are produced in the cathode chamber, while ultra-pure chlorine gas and diluted residual brine are produced in the anode chamber, separated by the diaphragm from the cathode chamber. The resulting ultra-pure chlorine gas is further processed in two ways. Firstly, it is suctioned off through an injector (included in the scope of delivery) and fully dissolved as hypochlorous acid in the water being treated (through a bypass). The superchlorinated water is then distributed throughout the various pools via one or more proportionately controllable motor driven ball valves. The vacuum is kept stable by a single frequency-controlled booster pump. This permits significant savings in terms of energy. If the complete production output is not needed, excess chlorine gas can also be combined with the sodium hydroxide produced and then temporarily stored as sodium hypochlorite. The system thus does not have to be dimensioned according to the maximum chlorine gas demand rather according to the average daily demand. Peaks in demand are met by the additional metering of sodium hypochlorite from the temporary storage, which, as with hypochlorous acid, is fed through a central injector system.

The chloride-free sodium hydroxide is stored temporarily and can be used for pH value correction. First the base pH (pH 6.8 – 7) of the superchlorinated water is corrected by a standard diaphragm metering pump or through the addition of sodium hypochlorite. Fine correction of the pH value is achieved by additional alkali metering pumps for each circuit or point of injection. They are connected directly to the system's control through an external pH value controller. The hydrogen produced is diluted with fresh air through an ATEX 95-approved fan and discharged safely. The diluted residual brine is fully discarded. To achieve this, the diluted brine is strongly diluted with softened water, neutralised by the addition of sodium hydroxide and disposed of in the sewer. Any residual chloride and chlorate are thus disposed of and are not mixed with the process water. Electrolysis systems of type CHLORINSITU® V Plus can thus be compared with pure chlorine gas in terms of their oxidation strength and chloride / chlorate content in the process water. The salt-dissolving water comes from a softener integrated in the system, preventing the formation of lime deposits and ensuring the long service life of the diaphragm cell. The efficiency of the electrolysis is constantly monitored by various flow meters, the addition of water depending on the sodium hydroxide production and the base pH correction.

Your benefits

- Chlorination and pH adjustment with a single system
- Exceedingly low chloride and chlorate content
- Reservoir of sodium hypochlorite solution to cover peak demand
- Production and metering of high-purity hypochlorous acid combined with sodium hypochlorite production
- Excellent service life of the membrane cells, thanks to a constant vacuum
- Maximum operating safety due to their design as negative pressure systems
- Active process control of production by largely internal measuring and control technology
- Cost-effective operation thanks to the use of sodium chloride as an inexpensive raw material and low consumption of chemicals for pH correction
- Robust technology
- Compact, space-saving design

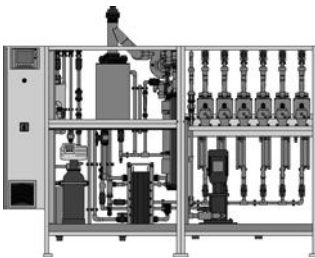

P_PMA_EL_0012_SW

Technical Details

- Modern PLC with large illuminated display
- Integrated Remote Control Engineer for remote diagnosis and troubleshooting
- Chlorine metering and pH value correction controlled via contact inputs
- Simultaneous production and metering of ultra-pure hypochlorous acid and sodium hypochlorite solution (optional)
- Analogue input (optional)
- MOD bus or PROFIBUS® (optional)
- Several points of injection (optional)
- Multiple booster pumps (optional) can be used for different water qualities (e.g. brine and freshwater pools)

Field of application

- Potable water
- Waste water
- Process water
- Swimming pool water
- Cooling tower

4 Electrolysis Systems CHLORINSITU® and DULCO® Lyse

Technical Data

Power supply 3 x 400 V (VAC/3P/N/PE/50 Hz)

Type/ output	Fuse	Power uptake	Max. salt consumption	Max. consumption of process water*	(External) consumption of cooling water	Dimensions L x W x H (mm)	Brine tank	Recommended capacity storage tank
g/h	A	kW	kg/d	l/h	l/h		l	l
100	3 x 16	1.10	5	60	–	1,655 x 600 x 1,550	130	50
200	3 x 16	1.50	10	60	–	1,655 x 600 x 1,550	130	100
300	3 x 16	1.90	15	60	–	1,655 x 600 x 1,550	200	150
400	3 x 16	2.30	20	60	–	1,655 x 600 x 1,550	200	200
500	3 x 16	2.70	25	60	–	1,655 x 600 x 2,000	200	250
600	3 x 20	3.10	30	90	–	1,950 x 600 x 2,000	380	300
750	3 x 25	3.70	40	90	–	1,950 x 600 x 2,000	380	400
1,000	3 x 25	4.70	55	90	–	1,950 x 600 x 2,000	380	500
1,250	3 x 35	5.70	60	90	–	1,950 x 600 x 2,000	380	600
1,500	3 x 35	6.70	75	90	–	1,950 x 600 x 2,000	380	750
1,750	3 x 35	7.70	85	90	–	1,950 x 600 x 2,000	380	850
2,000	3 x 50	8.70	100	175	200	1,750 x 1,200 x 2,000	520	1,000
2,500	3 x 63	10.70	125	175	250	1,750 x 1,200 x 2,000	520	1,250
3,000	3 x 63	12.70	150	175	300	1,750 x 1,200 x 2,000	520	1,500
3,500	3 x 80	14.70	175	175	350	1,750 x 1,200 x 2,000	520	1,750

* The consumption of process water depends on the ratio of chlorine gas to stock production. The value is given here for a ratio of 70% : 30 %.

Capacities > 3,500 g/h upon request

Scope of delivery:

Electrolysis systems of type CHLORINSITU® V Plus are ready mounted, wired for use, on a powder-coated stainless steel frame with a PLC Programmable Logic Controller in the control cabinet, Remote Control Engineer for remote diagnosis and troubleshooting, integral water softening unit, diaphragm electrolysis cells, ATEX-95-compliant bleed system and separate salt dissolving tank with level monitoring. The scope of delivery also includes a frequency-controlled central injector system matched to the system to meter active chlorine and sodium hydroxide for pH correction and a single booster pump. A level control to monitor the storage tank to be provided on site for sodium hypochlorite. A chlorine gas warning unit and automatic monitoring of water hardness downstream of the softening system come as standard with systems producing more than 600 g/h.

Note:

Electrolysis systems of type CHLORINSITU® II, III, V and V Plus are offered and planned to meet customer specifications. This is true both for the system documentation and the subsequent supply of spare parts and maintenance.

4 Electrolysis Systems CHLORINSITU[®] and DULCO[®]Lyse

4.10 Questionnaire on the design of a DULCO[®]Lyse electrolysis system

Application

- Bottler flushing
- CIP
- Other _____

Applicational details

Number of bottlers: _____

Flushing duration: _____

Required volume to be added to bottler: _____ Recommendation with material SS 316 L 2-4 ppm

Number of CIP points of injection: _____

Duration of CIP: _____

Required volume to be added for CIP: _____ Recommendation 10-15 ppm

Water data:

Max. volume of water to be treated _____ m³/h maximum water pressure _____ bar

Water flow constant fluctuating from _____ m³/h to _____ m³/h

pH value _____ (iron (Fe²⁺) _____ mg/l)

Temperature _____ °C (manganese (Mn²⁺) _____ mg/l)

Proportion of solids _____ mg/l (nitrite (NO₂⁻) _____ mg/l)

Acid capacity K_{s4,3} _____ mmol/l (sulphide (S²⁻) _____ mg/l)

Total hardness _____ mmol/l (TOC (total organic carbon) _____ mg/l)

Total hardness _____ °dH (ammonium _____ mg/l)

Reaction time to application:

_____ m³ volume of reaction tank or _____ minutes dwell time in the total system.

Disinfection method used to date:

Disinfectant consumed to date: _____ kg/week

Other requirements:

4 Electrolysis Systems CHLORINSITU® and DULCO®Lyse

4.11

Electrolysis System Dulco®Lyse

Innovative disinfection. Your advantage: No corrosion due to low chloride content.

Output of 100 – 300 g/h pure hypochlorous acid

Efficient production of DULCO®Lyt 400 (ECA water) with an exceptionally low chloride and chlorate content. Maximum protection against corrosion and very good cost efficiency because of low chloride.



Electrolysis systems of the type DULCO®Lyse generate pure hypochlorous acid in a vacuum process. A saturated solution of sodium chloride is produced in a salt-dissolving tank, included in the scope of delivery, and this solution is then electrolysed in a diaphragm cell. Chloride-free sodium hydroxide and hydrogen are produced in the cathode chamber, while ultra-pure chlorine gas and dilute residual brine are produced in the anode chamber, separated by the diaphragm from the cathode chamber. The chlorine gas produced is immediately separated from the residual brine and dissolved as hypochlorous acid. The sodium hydroxide is temporarily stored and added to hypochlorous acid through a metering pump. The result is a neutral, highly effective and extremely low-chloride and low-chlorate disinfection solution, temporarily stored in the product tank until metered through separate metering stations. The hydrogen produced is diluted with fresh air through an ATEX-inspected fan and discharged safely. The diluted residual brine is fully discarded. To achieve this, the diluted brine is strongly diluted with softened water, neutralised by the addition of sodium hydroxide and disposed of in the sewer. Any residual chloride and chlorate are thus disposed of and are not mixed with the process water. DULCO®Lyse systems can thus be compared with pure chlorine gas in terms of their oxidation strength and chloride and chlorate content in the process water. The salt dissolving water comes from a softening system integrated in the DULCO®Lyse system, thereby preventing the formation of lime deposits and ensuring the long service life of the electrolytic cell.

Your benefits

- Extremely low chloride and chlorate content for maximum protection and corrosion-free system technology
- Environmentally friendly, highly effective disinfection
- Long-term freedom from germs, without any transport, storage or handling of concentrated chemicals
- Handling of chemicals is reduced (only sodium chloride is required)
- Compact, space-saving design
- Cost-effective operation, thanks to use of inexpensive sodium chloride as a raw material

Technical Details

- Modern PLC with large illuminated display
- Integrated Remote Control Engineer for remote diagnosis and troubleshooting
- Supplied ready for connection in stainless steel housing
- Integrated softening system
- ATEX-certified bleeding system
- Integrated salt tank with level monitoring

Field of application

- Food industry
- Beverage industry

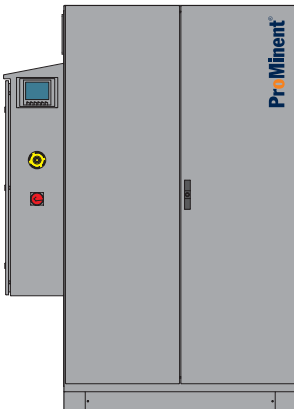

P_PMA_EL_0042_SW

4 Electrolysis Systems CHLORINSITU® and DULCO®Lyse

Technical Data

Power supply: 1 x 230 Volt (V AC/1P/N/PE/50 Hz)

Dimensions (H x W x D): 2,100 x 1,250 x 610 mm

	Type/ output g/h	DULCO®Lyt production at 400 ppm l/h	Power uptake kW	Salt solution tank volume l	Cabinet	Order no.
DULCO®Lyse 100	100	250	1.10	200	stainless steel cabinet	1041424
DULCO®Lyse 100	100	250	1.10	200	open cabinet	1062093
DULCO®Lyse 200	200	500	1.50	200	stainless steel cabinet	1043987
DULCO®Lyse 200	200	500	1.50	200	open cabinet	1062104
DULCO®Lyse 300	300	750	1.90	200	stainless steel cabinet	1043988
DULCO®Lyse 300	300	750	1.90	200	open cabinet	1062135

Scope of delivery:

DULCO®Lyse electrolysis systems are assembled ready-wired in a sealed stainless steel or open cabinet

- PLC (Programmable Logic Controller) in the attached control cabinet
- Integrated softening system
- Electrolysis cell(s)
- ATEX-certified bleeding system
- Integrated salt dissolving tank with level monitoring
- Ultrasound level probe for the DULCO®Lyt product tank
- Piping between the salt-dissolving storage tank and DULCO®Lyse system
- 25 kg salt for commissioning
- Hardness control measuring device
- pH4 + pH7buffer solution

Material not included in the scope of delivery:

- Sodium hydroxide (33 % needed for commissioning)
- DULCO®Lyt product tank
- DULCO®Lyt metering station
- Piping outside of the DULCO®Lyse

Spare parts and maintenance kits

	Type	Order no.
Annual maintenance kit	DULCO®Lyse 100 – 300	1041427
3-yearly maintenance kit	DULCO®Lyse 100 – 300	1041430
Spare parts kit	DULCO®Lyse 100 – 300	1044366

4 Electrolysis Systems CHLORINSITU® and DULCO®Lyse

4.12 Accessories

Water hardness measuring kit

For manual determination of the overall hardness

	Order no.
Water hardness measuring kit for overall hardness	505505

Metering systems for connection to DULCO®Lyse

Metering systems for connection to electrolysis systems DULCO®Lyse including 500 l product tank and solenoid-driven metering pump delta®. Maximum metering of FAC: 0.5 ppm.

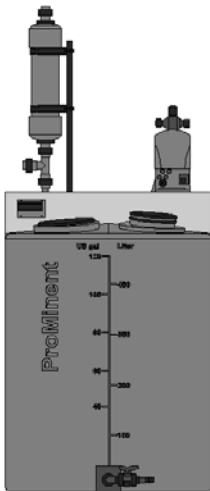

P_PMA_EL_0039

Water flow m ³ /h	Identity code for delta®	Pump capacity at max. back pressure		Order no.
		bar	l/h	
5 – 40	DLTA0450PVT2000UK1030DE0	4.0	50.0	1076955
5 – 60	DLTA0280PVT2000UK1030DE0	2.0	80.0	1077098

4

DULCO®Lyse product tanks for connection to the metering system DULCODOS® DSKa

Contents l	Order no.
500	1076956
1000	1076957

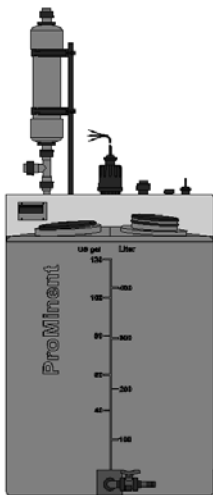

P_PMA_EL_0040

DULCO®Lyse new electrolysis cells

	Capacity g/h	Order no.
Membrane cell	100	1041433
HMC 10-2	200	1074133
HMC 10-3	300	1074134

4 Electrolysis Systems CHLORINSITU® and DULCO®Lyse

Metering systems DULCODOS® DSKa for connection to DULCO®Lyse product tanks

Metering system DULCODOS® DSKa for connection to DULCO®Lyse product tank, for motor-driven metering pump Sigma, electrically and mechanically ready mounted on a PP frame. Scope of delivery:

- Diaphragm damper
- Back pressure valve
- Relief valve including manometer
- Flushing connector for suction and discharge side
- Repair switch
- Select the metering pump separately, see Metering pumps table

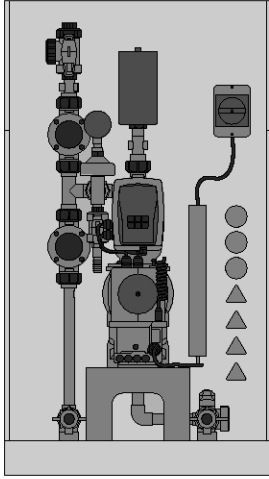

P_PMA_EL_0038

	Feed rate max. l/h	Order no.
Metering system for Sigma/ 1 (control type)	53 – 117	1083511
Metering system for Sigma/ 2 (control type)	150 – 350	1077030
Metering system for Sigma/ 3 (control type)	500 – 670	1077109
Metering system for Sigma/ 3 (control type)	670 – 1040	1083512

Recommended metering pumps for metering systems DULCODOS® DSKa:

Pump type	Identity code
Sigma/ 2 (control type)	S2CBH 07220 PVTS 010 U 1110S0 EN
Sigma/ 2 (control type)	S2CBH 04350 PVTS 010 U 1110S0 EN
Sigma/ 3 (control type)	S3CBH 070580 PVTS 110 U 1110S0 EN

Accessories for metering systems DULCODOS® DSKa

	Order no.
Spray guard hood for DULCODOS® DSKa	1042751
Spray guard hood for DULCODOS® DSKa for PP bracket without terminal box	1040456

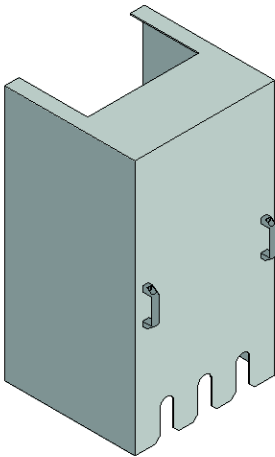

P_DST_0007

5 Chlorine Gas Metering Systems DULCO®Vaq

5.1 General Information on Chlorine Gas Metering Systems

Chlorine gas metering systems are used in water treatment for disinfection and oxidation. They prevent and/or reduce the growth of micro-organisms.

The safety of users is the priority. This is essentially guaranteed by vacuum operation directly from the chlorine gas tank and downstream of the evaporator. This ensures that the escape of chlorine gas can be prevented even in the event of a ruptured pipe.

All the components are perfectly coordinated to each other and ensure seamless operation. With higher demand, several storage tanks can be combined using manifolds. Uninterrupted chlorine gas supply can be ensured by the use of an automatic vacuum switch.

Chlorine gas stands out on account of its high bacteria destruction speed coupled with low operating costs. Due to the high level of reactivity, sensible handling and compliance with common safety regulations (e.g. DIN 19606, BGV D5 / DGUV-V 50, BGR/GUV-R 108 and other regional regulations) is imperative.

No by-products are metered by the use of pure chlorine gas and thus the water quality is maintained. Furthermore, chlorine gas can be stored as required without forming decomposition products.

Chlorine is a pungent smelling yellow/green gas in its normal state. The density is $\sim 3.2 \text{ kg/m}^3$, thus chlorine gas is heavier than air. Chlorine is supplied in liquid form and changes to its gaseous state during extraction caused by reduced pressure. The vacuum generated by an injector draws the chlorine gas by suction to the point of injection. The chlorine gas is dissolved in water and produces hypochlorous acid responsible for disinfection.

Make sure that only a technical expert carries out commissioning, maintenance and repair. Compliance with national and regional regulations is mandatory.

5.1.1

Chlorine Gas Metering Systems DULCO®Vaq

Chlorine is reliably handled under vacuum in the metering system DULCO®Vaq. The vacuum generated in the injector opens the vacuum metering controller fitted on the chlorine gas tank and the chlorine gas enters the water to be treated. Adjustment valves control the metering volume and flow meters precisely indicate the chlorine gas flow. A large number of individual configurations is provided for by additional components, such as motorised control valves, injectors or vacuum switches.

ProMinent specialists take into account all the technical safety-related requirements in the design of the chlorine gas metering system.

5 Chlorine Gas Metering Systems DULCO®Vaq

5.2 Performance Overview of Chlorine Gas Metering Systems DULCO®Vaq

The components of the DULCO®Vaq series are sub-divided into small and medium chlorine gas systems, as well as large systems, the suitability of which is as follows:

Applications	12 – 15,000 g/h	20 – 200 kg/h
Potable water	x	x
Swimming pool water	x	
Waste water	x	x
Cooling water	x	x

5.2.1 Instructions on the planning and design of a chlorine gas metering system

- 1 Chlorine gas cylinder
- 2 Vacuum metering controller
- 3 Vacuum switch-over
- 4 Vacuum safety valve
- 5 Active carbon filter
- 6 Gas warning sensor
- 7 Heating
- 8 Sprinkler system
- 9 Flashing light and horn
- 10 Automatic chlorine gas metering system
- 11 DULCOMARIN®
- 12 Gas detector
- 13 Process water set
- 14 Injector
- 15 Booster pump
- 16 Injection point

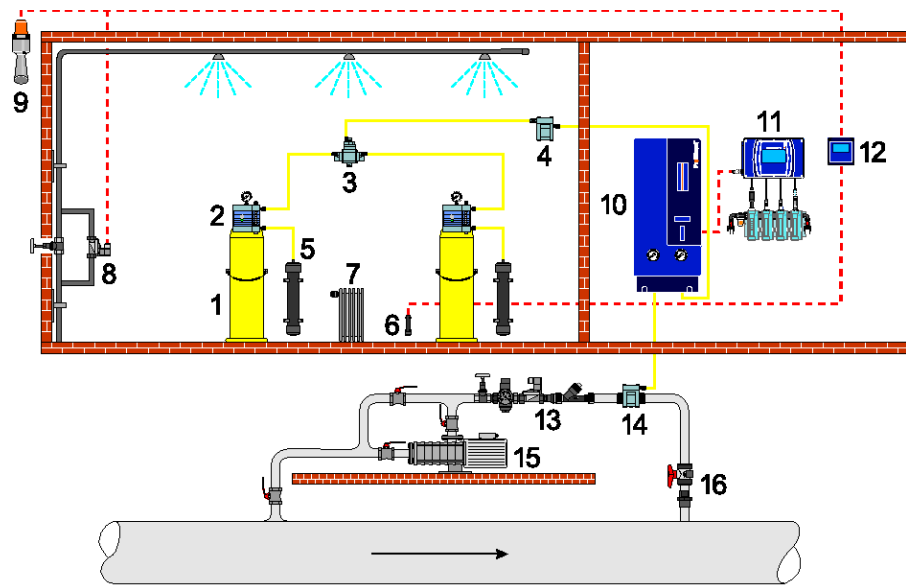

P_DV_0023

The following details are required for the design of a chlorine gas system:

- Purpose of use
- Maximum water flow of the water to be treated
- Maximum back pressure at the feed point

Individual plans for large systems and for specific applications on request.

5 Chlorine Gas Metering Systems DULCO®Vaq

5.3 Questionnaire on the Design of a Chlorine Gas Metering System

Use of the chlorine gas metering system:

- | | |
|--|---|
| <input type="checkbox"/> for disinfection of | <input type="checkbox"/> Drinking water
<input type="checkbox"/> Industrial water
<input type="checkbox"/> Process water in the food industry
<input type="checkbox"/> Waste water
<input type="checkbox"/> Cooling water
<input type="checkbox"/> _____ |
| <input type="checkbox"/> for oxidation of | <input type="checkbox"/> Iron, manganese, nitrite, sulphide etc.
<input type="checkbox"/> Swimming pool water
<input type="checkbox"/> Odour
<input type="checkbox"/> _____ |
| <input type="checkbox"/> _____ | |

Water values:

- | | | | |
|------------------------------|-----------------------------------|---|---------------------------|
| Max. water flow rate | _____ m³/h | Maximum water pressure | _____ bar |
| Water flow rate | <input type="checkbox"/> constant | <input type="checkbox"/> fluctuating from | _____ m³/h bis _____ m³/h |
| pH value | _____ | | |
| Temperature | _____ °C | | |
| Solid fraction | _____ mg/l | | |
| Alkalinity K _{S4,3} | _____ mmol/l | | |

Response time to application:

_____ m³/h volume reaction tank or _____ minutes residence time in entire system.

Type of metering:

- constant
- flow-proportional
- depending on measured value

Desired amount of metering: _____ mg/l

Desired concentration after chlorine dioxide metering: _____ mg/l

Other requirements:

P_DV_0001_SW

5 Chlorine Gas Metering Systems DULCO®Vaq

5.4 Vacuum dosing regulator for chlorine gas DULCO®Vaq



Chlorine gas metering – safe, robust and reliable

Capacity: up to 200 kg/h

The vacuum dosing regulator DULCO®Vaq CGVa meters chlorine gas cost-effectively and highly efficiently. Maximum possible operating safety and reliability is ensured by the use of high-quality materials, such as tantalum and silver.

Chlorine gas is reliably handled under vacuum with the vacuum dosing regulator DULCO®Vaq. The vacuum generated in the injector opens the inlet valve in the vacuum dosing regulator and the chlorine gas flows into the controller. There the chlorine gas is transferred into the vacuum directly downstream and drawn by suction in a controlled manner into the water to be treated. The optional control valve enables the volume of chlorine gas to be adjusted directly at the vacuum dosing regulator. The additional equipment includes a flow indicator to display the chlorine gas mass flow and a storage-tank-empty-signal. We offer accessories, such as adjustment valves, injectors, manometers or electrical status signals for individual requirements, enabling precise configuration and correct metering.

Your benefits

- Maximum safety thanks to the full vacuum system
- Maximum operating safety and reliability by the use of high-quality materials, like tantalum and silver
- Coordinated components and accessories

Technical Details

- Sturdy ABS housing
- All critical chlorine-wetted parts are made of high-grade materials, such as PTFE, tantalum and silver
- Flow indicator for display of the chlorine gas mass flow and an optical storage tank empty signal
- 5 different connector dimensions for the chlorine gas tank
- Manometer with limit contact to monitor the chlorine gas pressure in the storage tank (optional)
- Potential-free contact (not self-resetting) to signal the empty state of the chlorine gas storage tank (optional)
- Residual pressure safety mechanism (optional)
- Standard chlorine gas filter (optional from 20 kg/h)
- Adjustment valve with V0-nozzle for control of the gas volume

Field of application

- Potable water
- Swimming pool water
- Waste water
- Cooling water

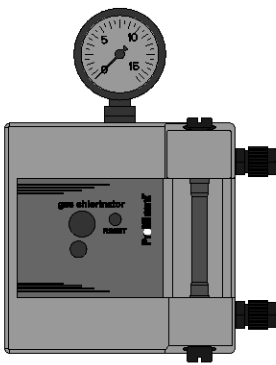

P_DV_0025_SW

Dimensional drawing (output 12 – 4,000 g/h)

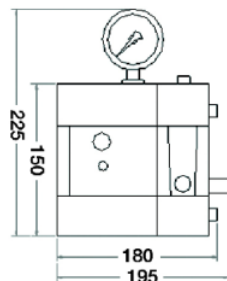

P_DV_0010_SW

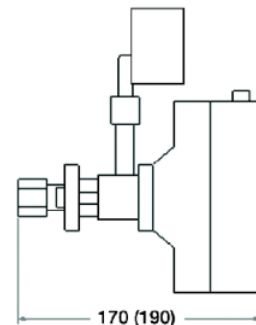

P_DV_0011_SW

5 Chlorine Gas Metering Systems DULCO®Vaq

Dimensional drawing (output 10 – 15 kg/h)

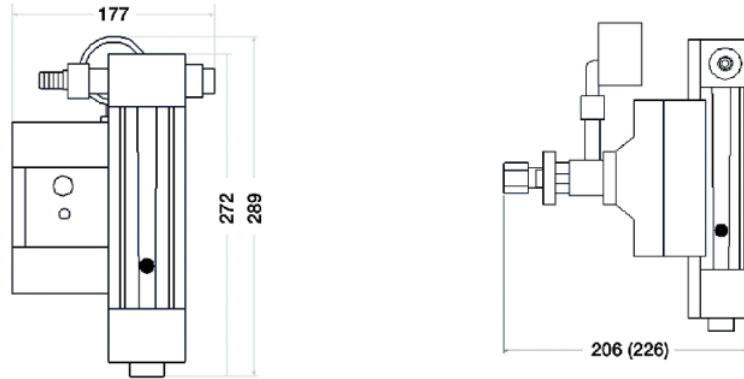

P_DV_0008_SW

P_DV_0009_SW

Requirement of vacuum line for chlorine gas

max. gas flow	Length of vacuum line					
	15 m	30 m	60 m	100 m	200 m	300 m
1,000 g/h	d8/d10	d8/d10	d8/d10	d8/d10	d8/d10	d8/d10
2,000 g/h	d8/d10	d8/d10	d8/d10	d8/d16	d8/d16	d20
4,000 g/h	d8/d10	d8/d10	d8/d16	d20	d20	d25
10 kg/h	d12/d16	d20	d25	d25	d32	d32
15 kg/h	d12/d16	d20	d25	d32	d40	d40
20 kg/h	d20	d25	d32	d40	d50	d50
40 kg/h	d25	d32	d40	d50	d50	d50
60 kg/h	d50	d50	d50	d50		
80 kg/h	d50	d50	d50	d50		
120 kg/h	d50	d50	d50	d50		
160 kg/h	d50	d50				
200 kg/h	d50	d50				

Technical Data

Type	Capacity kg/h	Connector on the vacuum side	Discharge side connector (standard)	Weight kg
CGVa012g	0.012	d8/d10	1"	3.1
CGVa025g	0.025	d8/d10	1"	3.1
CGVa100g	0.1	d8/d10	1"	3.1
CGVa200g	0.2	d8/d10	1"	3.1
CGVa500g	0.5	d8/d10	1"	3.1
CGVa001k	1	d8/d10	1"	3.1
CGVa002k	2	d8/d10	1"	3.1
CGVa004k	4	d8/d10*	1"	3.1
CGVa010k	10	d12/d16	1"	3.9
CGVa015k	15	d12/d16	1"	3.9
CGVa020k	20	d20 - 3/4"	G3/4"	19.0
CGVa040k	40	d25 - 1"	G3/4"	19.0
CGVa060k	60	d50 - 2"	G3/4"	19.0
CGVa080k	80	d50 - 2"	G3/4"	19.0
CGVa120k	120	d50 - 2"	D3/4"	19.0
CGVa160k	160	d50 - 2"	G1"	19.0
CGVa200k	200	d50 - 2"	G1"	19.0

* from 30 m pipe length: d12/d16

Precision: 4% of the flow

5 Chlorine Gas Metering Systems DULCO®Vaq

5.4.1 Identity code ordering system for vacuum metering controller DULCO®Vaq

CGVa	Type	Capacity		
		kg/h		
	CGVa012g	0.012		
	CGVa025g	0.025		
	CGVa100g	0.1		
	CGVa200g	0.2		
	CGVa500g	0.5		
	CGVa001k	1		
	CGVa002k	2		
	CGVa004k	4		
	CGVa010k	10		
	CGVa015k	15		
	CGVa020k	20		
	CGVa040k	40		
	CGVa060k	60		
	CGVa080k	80		
	CGVa120k	120		
	CGVa160k	160		
	CGVa200k	200		
		Design		
	P	ProMinent		
	M	modified		
		Flow meter with adjustment valve		
		0	none	
		1	with flow meter without adjustment valve (≤ 15 kg/h)	
		2	with flow meter with adjustment valve (≤ 15 kg/h)	
		Manometer		
		0	none	
		1	with	
		2	with manometer with limit contact	
		Empty signal contact		
		0	none	
		1	with (≤ 15 kg/h)	
		Residual pressure pressure lock		
		0	none	
		1	with (≤ 15 kg/h)	
		Connector		
		0	Standard (1")	
		1	1.030" CGA (≤ 15 kg/h)	
		2	5/8" BSP (≤ 15 kg/h)	
		3	M 27x1.5 (≤ 15 kg/h)	
		4	yoke (≤ 15 kg/h)	
		5	3/4" (≤ 15 kg/h)	
		Operating instructions		
		DE	German	
		EN	English	
		FR	French	
		ES	Spanish	

5.4.2 Vacuum controller accessories

Flow limiter 900 g/h

For limiting the throughput of a vacuum controller to 900 g/h for instance with continuously extraction from multiple cylinders. Designed as a PVDF fitting, screwed into the output of the vacuum controller.

	Order no.
Flow limiter 900 g/h	1082816

5 Chlorine Gas Metering Systems DULCO®Vaq

5.5 Motor-driven control valve for chlorine gas DULCO®Vaq



Chlorine gas metering, precisely regulated

Capacity: 12 g/h to 15 kg/h

The motorised control valve for chlorine gas DULCO®Vaq type PM 3531 ensures precise electronically controlled metering of the chlorine gas flow. The linear control characteristic is guaranteed by an externally controlled step motor.

The DULCO®Vaq motorised control valve is fitted in the vacuum system between the vacuum controller and injector. The chlorine gas flow is therefore automatically adjusted. A step motor thus adjusts the ultra-precise V-nozzle, which results in a linear control characteristic. Control is either provided by manual adjustment on the keyboard of the device, via external signals, such as 0/4-20 mA, 0/2-10 V or ModBus. Opening and operating statuses are signalled externally by analogue and digital outputs and by LEDs on the device. In the event of power failure, the valve closes automatically, although mechanical manual operation is possible.

Your benefits

- Linear control action for precise metering
- Multiple control and signalling functions
- Automatic and manual operation
- Calibratable
- Automatic safety shut-off
- Easy control e.g. using DULCOMARIN® or DACb controller

Technical Details

- External control via 0/4-20 mA , 0/2-10 V or ModBus
- Manual operating mode, which can be adjusted by the keyboard on the device
- Mechanically adjustable emergency mode
- Control via V-nozzle with ± 5 % control precision
- 5-point calibration
- Manometer for vacuum display
- 4-20 mA output
- Fault indicating output (potential-free contact)
- LED display of the opening status
- Power supply 24 V DC
- Protection class IP 65

Field of application

- Potable water
- Swimming pool water
- Waste water
- Cooling water

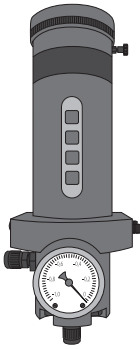

P_DV_0012_SW

5 Chlorine Gas Metering Systems DULCO®Vaq

Technical Data

Weight: 2.9 kg

Dimensions: 320 x 120 x 160 mm

with vacuum meter

Capacity kg/h	Connector	Order no.
0.012	d8/d10	1077197
0.025	d8/d10	1077198
0.1	d8/d10	1077199
0.2	d8/d10	1077200
0.5	d8/d10	1077201
1	d8/d10	1077202
2	d8/d10	1077203
4	d8/d10	1077204
10	d12/d16	1077205
15	d12/d16	1077207

without vacuum meter

Capacity kg/h	Connector	Order no.
0.012	d8/d10	1078422
0.25	d8/d10	1078425
0.1	d8/d10	1077723
0.2	d8/d10	1077764
0.5	d8/d10	1078426
1	d8/d10	1078427
2	d8/d10	1078428
4	d8/d10	1078429
10	d12/d16	1078430
15	d12/d16	1078432

Note: A flow meter needs to be fitted to read off the exact flow and calibrate the motorised control valve. Not included in the scope of delivery.

5 Chlorine Gas Metering Systems DULCO®Vaq

5.6 Vacuum switch-over for chlorine gas DULCO®Vaq



Uninterrupted chlorine gas supply by the automatic changeover between chlorine gas storage tanks.

Capacity: 12 g/h to 120 kg/h

Vacuum switches DULCO®Vaq PM 400 and 440 automatically and reliably switch between two chlorine gas storage tanks. They therefore ensure an uninterrupted chlorine gas supply, even if a chlorine gas storage tank becomes empty.

DULCO®Vaq PM 400 and 440 are used where uninterrupted chlorine supply must be ensured. The vacuum switch-over switches to a second connected storage tank in the event of a storage tank becoming empty, solely vacuum-operated and without external auxiliary energy.

Your benefits

- Automatic switchover of chlorine gas sources
- Purely vacuum-operated system without external auxiliary energy
- Simple assembly and commissioning

Technical Details

- 5 capacities up to 120 kg/h
- ABS housing with hose connector for devices up to 10 kg/h
- PVC housing with threaded connector and straight solvent union for devices up to 120 kg/h via indicator box
- Potential-free contacts for the display of the chlorine gas source currently used (optional)

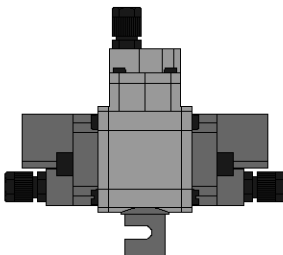

P_DV_0024_SW

Field of application

- Potable water
- Swimming pool water
- Waste water
- Cooling water

- 1 Chlorine gas cylinder
- 2 Vacuum metering controller
- 3 Vacuum switch-over
- 4 Vacuum safety valve
- 5 Active carbon filter
- 6 Gas warning sensor
- 7 Heating
- 8 Sprinkler system
- 9 Flashing light and horn
- 10 Automatic chlorine gas metering system
- 11 DULCOMARIN®
- 12 Gas detector
- 13 Process water set
- 14 Injector
- 15 Booster pump
- 16 Injection point

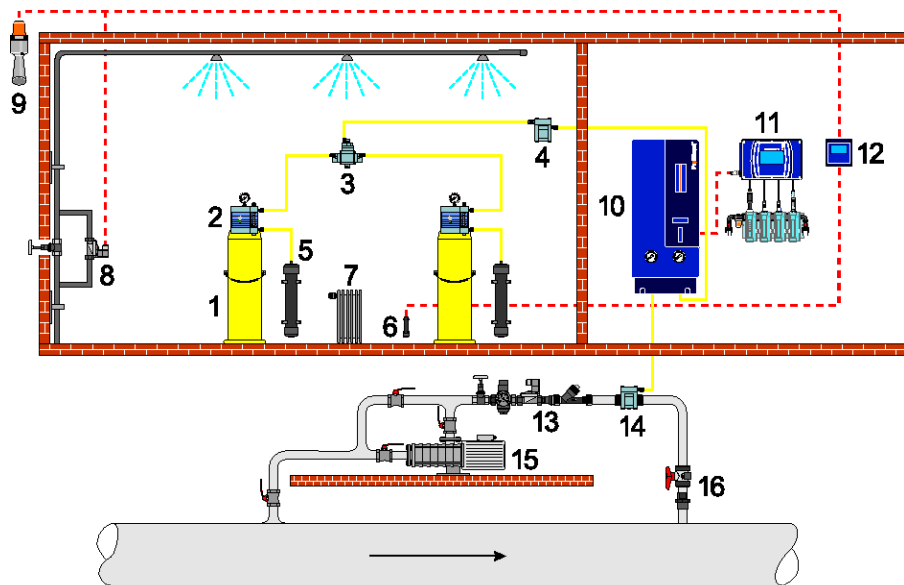

P_DV_0023

5 Chlorine Gas Metering Systems DULCO®Vaq

Technical Data

Capacity kg/h	Hose connector	PVC threaded connector	Electrical contact	Weight kg	Order no.
4	d8/d10	–	none	0.5	1055838
4	d8/d10	–	with	0.5	1055839
10	d12/d16	–	none	0.5	1060293
10	d12/d16	–	with	0.5	1077183
40	–	d25	none	3.3	1075780
40	–	d32	none	3.3	1077185
40	–	d40	none	3.3	1077187
80	–	d40	none	10.0	1077190
80	–	d50	none	10.0	1077192
120	–	d50	none	10.0	1077195

Indicator box

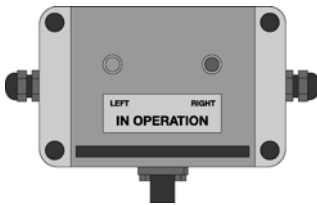

P_DV_0031_SW

Indicator box for connection to the vacuum switch-over. With two LEDs for displaying the active chlorine gas source (Duty/ Standby). Only for use with vacuum switch-over with electrical contact.

Power connection: 24 V DC
Degree of protection: IP 65
Dimensions: 140 x 80 mm

	Order no.
Indicator box PM3290 C	1082815

Chlorine gas switch for pressure equipment

Ensures a continuous supply of gaseous or liquid chlorine under pressure.

The switch-over consists of two electrically controlled electric ball valves, two pressure sensors and a control box. The control box indicates which side is in operation.

Power connection: 230 VAC

	Order no.
Chlorine gas switch up to 50 kg/h 3/4" NPT	1082733
Chlorine gas switch up to 200 kg/h 1" NPT	1082814

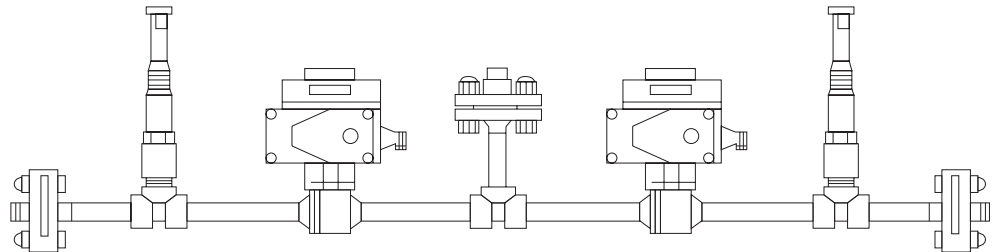

P_DV_0032_SW

5 Chlorine Gas Metering Systems DULCO®Vaq

5.7 Injector for Chlorine Gas DULCO®Vaq



Safe vacuum technology

Capacity: 12 g/h to 200 kg/h

Injectors for chlorine gas, series DULCO®Vaq, generate a stable vacuum even at high operating pressures.

A defined vacuum adapted to the operating statuses and performance requirements is required to meter chlorine gas safely and on-demand.

Your benefits

- Safe vacuum generation
- Up to 40 bar back pressure
- Integrated non-return valve
- Versatile installation models
- Durable housing

Field of application

- Potable water
- Swimming pool water
- Waste water
- Cooling water

Note: Injector curves are available for all of the models for selecting suitable booster pumps.

Type PM 306, standard with PVC threaded connector, water inlet DN 25 (1"), water outlet DN 25 (1")

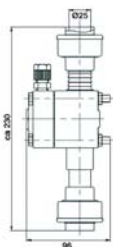

P_DV_0014_SW

Capacity kg/h	Connector on the vacuum side	Order no.
0.2	d8/d10	1055831
0.5	d8/d10	1055832
1.0	d8/d10	1055833
2.0	d8/d10	1055834
4.0	d8/d10	1055835

Type PM 305, standard with R5/4"

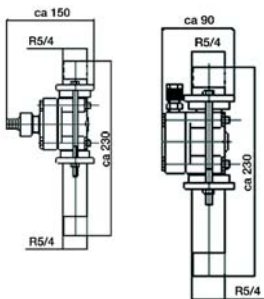

P_DV_0015_SW

P_DV_0016_SW

Capacity kg/h	Connector on the vacuum side	Order no.
4.0	d8/d10	1077174
10.0	d12/d16	1060290
15.0	d12/d16	1077175

5 Chlorine Gas Metering Systems DULCO®Vaq

Type PM 300, with immersion pipe R3/4", pressure < 6 bar, water inlet R3/4", water outlet R3/4"

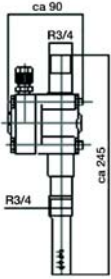

P_DV_0017_SW

Capacity kg/h	Connector on the vacuum side	Order no.
0.2	d8/d10	1055822
0.5	d8/d10	1055823
1.0	d8/d10	1055824
2.0	d8/d10	1055825
4.0	d8/d10	1055826

Type PM 301, reinforced for pressure up to 20 bar, water inlet DN 32 (1 1/4"), water outlet DN 32 (1 1/4")

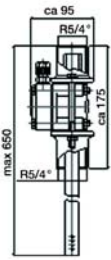

P_DV_0018_SW

Capacity kg/h	Connector on the vacuum side	Order no.
0.2	d8/d10	1055827
0.5	d8/d10	1055828
1.0	d8/d10	1055829
2.0	d8/d10	1055830

Type PM 340, flange DN 50, water inlet DN 50 (2"), water outlet DN 50 (2")

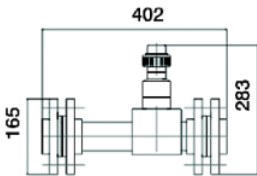

P_DV_0019_SW

Capacity kg/h	Connector on the vacuum side	Order no.
20.0	d20/d25/d32/d40	1077176
40.0	d20/d25/d32/d40	1077177

Type PM 350, flange DN 80

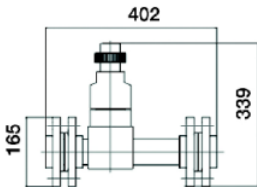

P_DV_0020_SW

Capacity kg/h	Water inlet	Water outlet	Connector on the vacuum side	Order no.
60	DN 80 (3")	DN 80 (3")	d32/d40/d50	1077178
80	DN 80 (3")	DN 80 (3")	d32/d40/d50	1077179
120	DN 80 (3")	DN 80 (3")	d32/d40/d50	1077180
160	project-specific	project-specific	-	1077181
200	project-specific	project-specific	-	1077182

5

5 Chlorine Gas Metering Systems DULCO®Vaq

5.8 Flow Meter for Chlorine Gas DULCO®Vaq

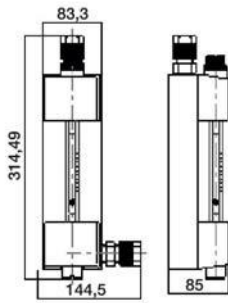

P_DV_0021_SW

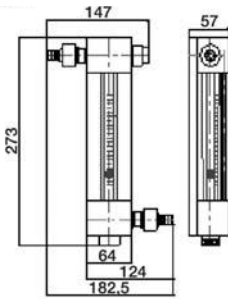

P_DV_0022_SW

Flow meter for chlorine gas with which the chlorine gas flow can be adjusted by the integral control valve. The chlorine gas flows through the measuring cylinder from the bottom to the top and a float indicates the chlorine flow on the scale.

The flow meters consist of a base plate, surrounds for the measuring cylinder, a measuring cylinder and the control valve. The size of the flow meter is based on the flow of chlorine gas required. The capacity ranges from 12 g/h to 200 kg/h.

The integral control valve and the measuring cylinder are designed for maximum precision.

Capacity kg/h	Hose connector	PVC threaded connector	Order no.
0.012	d8/d10	–	1055798
0.025	d8/d10	–	1055800
0.1	d8/d10	–	1055801
0.2	d8/d10	–	1055802
0.5	d8/d10	–	1055803
1	d8/d10	–	1055804
2	d8/d10	–	1055805
4	d8/d10	–	1055806
10	d12/d16	–	1060291
20	–	d20	1077158
40	–	d25	1077159
60	–	d32	1077160
80	–	d32	1077161
120	–	d32	1077162
160	–	d40	1077163
200	–	d50	1077164

5 Chlorine Gas Metering Systems DULCO®Vaq

5.9 Automatic emergency shut-off system for chlorine gas DULCO®Vaq

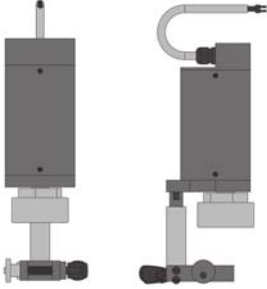

P_DV_0003_SW

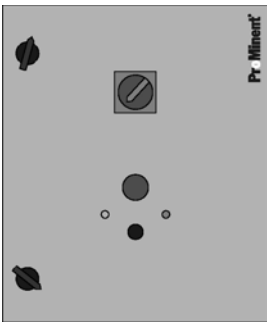

Operating unit

The DULCO®Vaq emergency shut-off system, coupled with a chlorine gas detection device, ensure the automatic and immediate closure of the chlorine gas valve in the event of a leak.

The servomotors sit directly on the chlorine gas valve of the storage tank and are controlled by an appropriate control cabinet. This transmits the signal to close as soon as the chlorine gas detection device detects a leak. The emergency shut-off system then closes the storage tanks in under 4 seconds.

The emergency shut-off systems can also be manually triggered by an emergency stop switch fitted outside the storage room. The operator must manually re-open the chlorine gas valves after securing the environment and rectifying a possible leak.

The emergency shut-off system is protected by an uninterrupted power supply (UPS) from power failure.

A separate operating units is needed, which has to be selected based on the actuators, for the independent operation of the emergency shut-off system. This needs to be selected separately and depending on the required number of actuators.

- Electrically operated and secured by uninterrupted power supply
- Reliably closes in under 4 seconds
- Suitable for chlorine gas cylinders and drums
- Easy to install with quick-release clips for tool-free assembly and dismantling
- Adapters available for all valves
- Adjustable torque for secure closure
- Designed to satisfy the highest standards

	Order no.
Actuator for valves with handwheel	1077242
Actuator for valves with square stem (with clamp)	1077243
Operating unit PM3800/2 for 2 actuators	1082409
Operating unit PM3800/6 for up to 6 actuators	1077244
Operating unit PM3800/10 for up to 10 actuators	1082411
Actuator for valves with handwheel (with clamp)	1082413
Actuator for valves with square stem and yoke connection	1083832

5 Chlorine Gas Metering Systems DULCO®Vaq

5.10 Automatic chlorine gas metering system DULCO®Vaq

Maximum safety and precision in chlorine gas metering.

Capacity: 12 g/h - 15 kg/h



The chlorine gas metering system DULCO®Vaq type PM 3610 C for automatically controlled metering of chlorine gas. Its simple operation offers safety and precision in accordance with the current state of technology and in line with DIN standards.

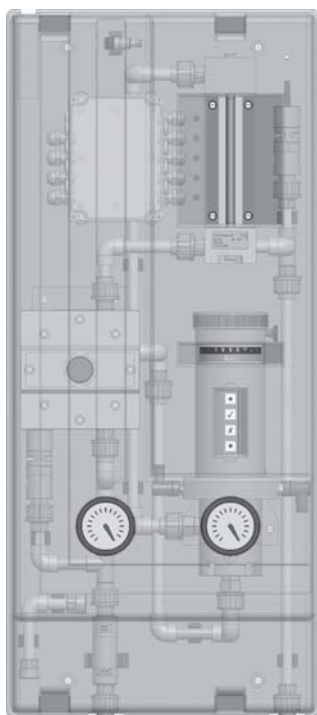

P_DV_0026_SW

NEW

The automatic chlorine gas metering system DULCO®Vaq type PM 3610 C is fitted in the vacuum system between the vacuum controller and injector. The chlorine gas flow is therefore automatically adjusted. A step motor controls an ultra-precise V-nozzle, enabling a linear control characteristic over a wide range. Control is by means of external control, such as analogue signals, 0/2 - 10 V, Modbus or by manually setting on the device's keypad. Opening and operating statuses are signalled externally by analogue and digital outputs and by LEDs on the device. In the event of power failure, the valve closes automatically, although mechanical manual operation is possible. The flow of chlorine gas is displayed on a long-scale flow meter and is held constant by the integrated differential pressure switch even with fluctuating pressure conditions.

Manometers display both the injector vacuum as well as the operating vacuum.

The entire system is ready-wired and mounted on a PVC panel and protected by an appropriate cover.

Your benefits

- Automatic chlorine gas metering
- Plug and Play
- DIN 19606-compliant
- Panel-mounted system
- Wide-ranging controllable motorised control valve
- Functional cover hood

Technical Details

Full vacuum chlorine gas metering system Type PM 3610 C including:

- Motor control valve PM 3531 C, capacity up to 15 kg/h with V-control nozzle with 1:20 adjustability, with automatic, proportional metering via 4-20 mA signal.
- LED indicator for opening status
- 5-Point calibration
- Simple manual or automatic operation
- Potential-free contact for error reporting
- Large-scale flow meter (165 mm) to an accuracy of $\pm 4\%$
- Differential pressure regulator in conformity with DIN 19606
- Manometer for displaying operating vacuum
- Manometer for displaying injector vacuum
- Non-return valve at the outlet
- Power supply: 230 VAC 50/60 Hz
- Vacuum switch optional

Field of application

- Potable water
- Swimming pool
- Waste water
- Cooling water

Technical Data

Dimensions: 896 x 396 x 210 mm

Weight: 6.5 kg

	Capacity kg/h	Order no.
Chlorine gas metering system PM3610C/5UDP	0.5	1082492
Chlorine gas metering system PM3610C/6UDP	1	1082493
Chlorine gas metering system PM3610C/7UDP	2	1082504
Chlorine gas metering system PM3610C/8UDP	4	1082505
Chlorine gas metering system PM3610C/9UDP	10	1083574
Chlorine gas metering system PM3610C/15UDP	15	1083575

5 Chlorine Gas Metering Systems DULCO®Vaq

5.11 Accessories

5.11.1 Accessories for chlorine gas metering

Active carbon absorption tank

Absorption storage tank for chlorine gas with active carbon filling.
For the connection to the safety vent of the vacuum regulator.

	Order no.
Active carbon filter	1055840
Replacement filling (3 kg)	1075273

Vacuum safety valve

The vacuum safety valve PM 3903 is used to prevent pressure in the vacuum line to the injector. Design complies with DIN 19606.

	Order no.
Vacuum safety valve, 4 kg/h, 10 x 8 mm connector	on request
Vacuum safety valve, 15 kg/h, 16 x 12 mm connector	1082417

Vacuum line

Vacuum-resistant PE hose material to connect up the components in the chlorine gas metering system.

	Order no.
Hose PE-LD d8/d10	1055837
Hose PE-LD d12/d16	1077236

Vacuum shut-off valve

Manual shut-off valve PVC-U for installation in the vacuum line.

	Order no.
Cl ₂ vacuum shut-off valve d10x8	1056321
Cl ₂ vacuum shut-off valve d16x12	1056322

Chlorine gas non-return valve

Mechanical non-return valve for the vacuum line. As additional backup against the ingress of water from the injector into the chlorine gas metering system.

	Order no.
Non-return valve type PM 3901 PVC-U 10 x 8	1055836

Differential pressure regulator

The differential pressure regulator adjusts any fluctuations within the vacuum before and after the rate valve and ensures constant metering. Complies with DIN 19606.

	Flow kg/h	Connector	Order no.
Differential pressure regulator PMDP20	4	10x8	1077165
Differential pressure regulator PMDP20	4 ... 10	16x12	1077167
Differential pressure regulator PMDP20	15	d20	1077168
Differential pressure regulator PMDP40	20	d20	1077169
Differential pressure regulator PMDP40	40	d25	1077170
Differential pressure regulator PMDP50	80	d40	1077171
Differential pressure regulator PMDP50	120	d50	1077172

5 Chlorine Gas Metering Systems DULCO®Vaq



Injection lance

To feed the chlorinated water from the injector bypass into the main water line. With a PVC lance, which can be cut to the corresponding pipe diameter.

	Connector	Order no.
Cl ₂ injection lance PVC-U	DN 20 R1" PN 16	1056317
Cl ₂ injection lance PVC-U	DN 25	1056318
Cl ₂ injection lance PVC-U	DN 32	1056319
Cl ₂ injection lance PVC-U	DN 40	1056320

Water Inlet Assemblies

Water inlet assembly for installation in the water line to the injector. Protects the injector nozzle from dirt thanks to the filter insert integrated in the pressure reducer. Displays the injector pressure. Maximum priming pressure 10 bar.

The following fittings can be selected:

- A – Manual shut-off valve
- D – Pressure reducer with manometer and filter insert; brass
- M – Solenoid valve 24 or 230 V AC; brass
- R – Non-return valve, PVC-U

	Order no.
Water inlet assembly ADR G3/4"	1082170
Water inlet assembly ADR G1	1082303
Water inlet assembly ADR G1 1/4"	1082334
Water inlet assembly ADR G1 1/2"	1082335
Water inlet assembly ADM G3/4" 24 V AC	1082336
Water inlet assembly ADM G1" 24 V AC	1082337
Water inlet assembly ADM G 1/4" 24 V AC	1082338
Water inlet assembly ADM G 1/2" 24 V AC	1082339
Water inlet assembly ADM G3/4" 230 V AC	1082340
Water inlet assembly ADM G1" 230 V AC	1082341
Water inlet assembly ADM G 1/4" 230 V AC	1082342
Water inlet assembly ADM G 1/2" 230 V AC	1082343
Water inlet assembly ADMR G3/4" 24 V AC	1082344
Water inlet assembly ADMR G1" 24 V AC	1082345
Water inlet assembly ADMR G 1/4" 24 V AC	1082346
Water inlet assembly ADMR G 1/2" 24 V AC	1082347
Water inlet assembly ADMR G3/4" 230 V AC	1082348
Water inlet assembly ADMR G1" 230 V AC	1082349
Water inlet assembly ADMR G 1/4" 230 V AC	1082350
Water inlet assembly ADMR G 1/2" 230 V AC	1082351

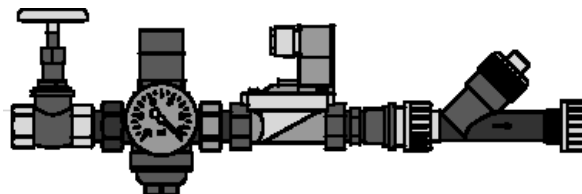

P_DV_0027_SW

5 Chlorine Gas Metering Systems DULCO®Vaq

5.11.2

Accessories for room and safety equipment

Chlorine gas cylinder support bracket

Wall-mounted galvanised steel U-profile to secure the chlorine gas cylinders from toppling over. With adjustable chain length.

	Order no.
Wall bracket for chlorine gas cylinder	1058803

Wall bracket for vacuum controller

For the safe storage of the vacuum controller when changing bottles.

	Order no.
Wall bracket for vacuum controller, plastic	1058804
Wall holder for yoke connector, galvanised steel	1079251

Gas detector Neon® Gas Chlorine Gas

The gas detector type Neon® Gas Chlorine Gas is designed as a compact measuring and switching unit for monitoring the ambient air for dangerous concentrations of chlorine gas.

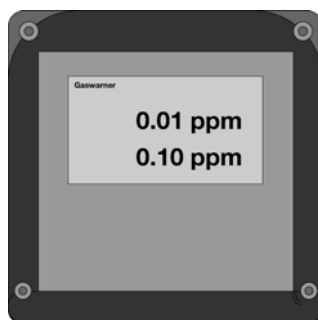

P_DV_0030_SW

Technical Data

Type	Chlorine gas
Warning at approx.	0.3 ppm/vol%
Alarm at approx.	0.5 ppm/vol%
Permissible ambient temperature	0...50°C
Protection class housing	IP 65
Dimensions (without PGs, without sensor) H x W x D	144 x 144 x 156 mm
Supply	85 – 265 / 50 – 60 V/Hz
Power consumption	10 W
Warm-up phase max.	150 s
"Warning" relay contact, self-resetting	250 V ; 6 A
"Alarm" relay contact, latching	250 V ; 6 A
"Horn" relay contact, latching, can be acknowledged	250 V ; 6 A
Sensor measuring principle	amperometric
Sensor service life (depending on ambient conditions)	1 years

Note: The sensor reacts to all oxidising gases.

	Order no.
Gas detector neon® Cl ₂ 1 sensor	1083162
Gas detector neon® Cl ₂ 2 sensors	1083163
Chlorine gas sensor GE710CL2 10 ppm	1082468

Flash light-horn

Combined horn and red warning lamp. IP 33 housing made of impact-resistant grey ABS with a clear polycarbonate dome. Connected load: 230 V AC, 50 mA.



	Order no.
Flash light-horn, red with continuous tone	1083160

5 Chlorine Gas Metering Systems DULCO®Vaq

Neutralisation system PM6100C

For the suction and neutralisation of the chlorine gas in the event of an escape of chlorine gas within the storage room.

The neutralisation system thus protects the chlorine gas storage room, the installations in the building and personnel.

The chlorine gas neutralisation system is started either manually or automatically by a signal from the chlorine gas detector. A pump is activated, which pumps the neutralisation solution at high speed through a special injector and generates a vacuum by means of a venturi effect. This vacuum draws the contaminated ambient air by suction out of the chlorine gas storage room into the neutralisation solution and thereby makes the escaped chlorine safe. The purified exhaust air is discharged.

The neutralisation system essentially consists of:

- Storage tank for the neutralisation solution
- Special chemical- and temperature-resistant pump for the injector
- Vacuum injector to draw off the contaminated air by suction

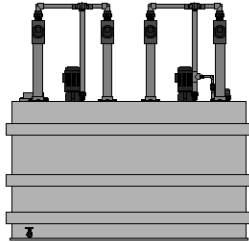

P_DV_0006_SW

	Order no.
Chlorine gas neutralisation system	on request

Combination emergency shower

Emergency shower made of stainless steel for use indoors. With DVGW certification. The body shower is actuated by a pull rod lever.

Connector 1 1/4" female thread

Dimensions (approx.): (DxWxH) 750 x 340 x 2,300 mm

	Order no.
Combination emergency shower EXP-18GS/45G (DVGW)	1041245

BasicLine emergency shower with sign

BasicLine body shower with eye shower, floor-mounted.

Water connection: 1 1/4" female thread

Radius: 640 mm

Overall height: 2,270 mm

	Order no.
BasicLine emergency shower with information sign	1082512

Floor actuation for BasicLine emergency shower

Floor actuation for industrial emergency showers in addition to the pull rod. Material: Plastic grille with stainless steel frame

	Order no.
Floor actuation for BasicLine emergency shower	1082513

Condensation heater PM3003

For installation on the dripleg.

	Order no.
Condensation heater PM3003 10 W 220/24 V AC	1075198

5 Chlorine Gas Metering Systems DULCO®Vaq

Complete set of signs for chlorination systems

Complete set of signs for chlorine gas room – inside (plastic) and outside (aluminium)

	Order no.
Complete set of signs for chlorination systems, German	1078436
Complete set of signs for chlorination systems, English	1078437



Empty/Full chlorine bottle sign with chain

Engraved reversible plate with stainless steel chain.

- Dimensions: 175 x 50 mm

	Order no.
Empty/Full chlorine bottle sign with chain	1082101

Emergency equipment

To safeguard against leakages in the valve area or wall area of the chlorine gas storage tank in an emergency. For the wall area with pressure plate, clamping block and unclamping mechanism with chains. For the valve area with protective cap with flange valve and unclamping mechanism with chains.

	Order no.
Emergency equipment 65 kg for chlorine gas bottles in valve area	1082100
Emergency equipment 50 kg for chlorine gas bottles in valve area	1082183
Emergency equipment 500 kg for chlorine gas drums in wall area	1082184
Emergency equipment 1,000 kg for chlorine gas drums in wall area	1082185
Chlorine Institute Kit "A" emergency equipment for chlorine gas bottles	1082265
Chlorine Institute Kit "B" emergency equipment for 1-tonne chlorine drums	1082167

Sprinkler system for the chlorine gas room

According to BGR/GUV-R 108 chlorine gas rooms have to be equipped with a chlorine gas disposal facility, with which the escaping chlorine gas can be harmlessly and effectively removed.

The sprinkler system consists of a main shut-off valve, a bypass and spray jets. The main shut-off valve with the bypass is fully ready mounted as a unit. The bypass consists of two manual shut-off valves and a solenoid valve. The spray jets are also ready mounted as units in two different designs.

	Order no.
Sprinkler system without nozzle DN 20 PVC-U 230 V AC	1082605
Sprinkler system without nozzle DN 32 PVC-U 230 V AC	1082606
Spray nozzle, complete L90° DN 20 PVC-U	1082607
Spray nozzle, complete L90° DN 32 PVC-U	1082608
Spray nozzle, complete T90° DN 20 PVC-U	1082609
Spray nozzle, complete T90° DN 32 PVC-U	1082610

5 Chlorine Gas Metering Systems DULCO®Vaq

5.11.3

Other accessories

Wall fans

Wall-mounted axial ventilators for ventilation of chlorine gas chamber. DN 500 with quadratic mounting plate and automatic cover flap.

	Output m ³ /h	Order no.
Wall fan 400 V 50 Hz	5,800	1082412
Wall fan 400 V 50 Hz	2,500	1082410
Wall fan 400 V 50 Hz	1,150	1082408

Chlorine gas storage tank

High-grade safety-tested chlorine gas storage tank for use as original equipment or spare part. Supplied empty without chlorine gas.

	Volume l	Order no.
Steel cylinder empty 52 l with valve W 1x8/1"	52	1082133
Chlorine gas storage tank 45 bar P355NL1 EN14208	400	1082164
Chlorine gas storage tank 45 bar P355NL1 EN14208	840	1082165

Weighing systems and drum storage

To monitor and check the liquid level of chlorine gas bottles and drums. Barrel storage for the safe storage and alignment of the chlorine gas drums.

	Order no.
Electrical bottle scales GR100K-1 1 x 150 kg	1082138
Electrical bottle scales GR100K-2 2 x 150 kg	1082139
Hydraulic bottle scales 4D100K-1 1 x 150 kg	1082140
Hydraulic bottle scales 4D100K-2 2 x 150 kg	1082141
Drum scales DR20K 2,000 kg with electronic display	1082136
Drum scales DR40K 4,000 kg with electronic display	1082415
Drum scales 8D20K 2,000 kg with hydraulic display	1082564
Drum scales 8D40K 4,000 kg with hydraulic display	1082565
Drum storage on wheels, steel with PE wheels, max. 2,000 kg	1082135
Drum pallet , galvanised steel	1082166

Crane beam and crane scales

For the safe transport and loading of chlorine gas drums up to max. 2 tonnes.

	Order no.
Crane beam for drum length 2,022–2,076 mm steel	1082137
Chain hoist HZE020 2,000 kg 3,0 m	1082294
Digital crane scales 3,000 kg IP67 230 V SS	1082295
Electrical chain hoist 2,000 kg 400 V 50 Hz IP55	1082296
Chain container BD4 for 4 m chain length	1082297
Cable trolley for power supply, width 132 mm	1082298

5 Chlorine Gas Metering Systems DULCO®Vaq

Reaction tower with granulated marble

During the chlorination of water, hydrochloric acid, which lowers the pH value of the water, is also produced alongside the hypochlorous acid, which has an excellent disinfection effect. If there is insufficient carbonate hardness in the water, the buffer capacity is inadequate and can be replaced in the form of reaction filters with granulated marble.

Filter storage tank made of glass fibre-reinforced epoxy resin with a seamless ABS inner liner.

- Operating pressure: max. 10 bar
- Operating temperature: max. 50 °C
- Volume: 170 or 310 litres
- Diameter of the tank: 552 mm

	Order no.
Reaction tower HClO 170 l 10 bar epoxy/PE	1082168
Reaction tower HClO 310 l 10 bar epoxy/PE	1082169
Filter material CaCO ₃ 4.0 – 6.0 mm unit kg	1082544

5.11.4

Personal safety equipment

Full face mask Dräger X-Plore 6300

Efficient and cost-effective full protection respiratory mask without filter made from EPDM and a viewing panel made from scratchproof PMMA for a 180° wide-angle view.

	Order no.
Dräger full mask XP 6300 EN136 class 2	1082117

Dräger X-plore breathing filter

For full mask XP 6300. Specifically suitable for use in chlorine gas systems.

	Order no.
Dräger X-plore breathing filter Rd40 940A2B2 EN143	1082118

Safety boots

Water-tight and slip-resistant.

	Order no.
Safety boots, yellow Size 45 PVC S5 SRA	1082122

Acid apron

	Order no.
Acid apron 100 x 120 cm PVC with fabric; black	1082123

Compressed air breathing apparatus, Diablo Rina 1800 Marine

- Back carrier panel with belt strap carrier
- Overpressure breathing regulator
- Pressure reducer with safety valve
- Manometer
- Acoustic warning device
- including full mask C607/SPA (Class 3) with screw connector M45x3 (DIN EN 148-3)
- including compressed air cylinder (6 l, 300 bar) steel
- Operating period approx. 45 minutes (1800 l breathing air)

	Order no.
Compressed air breathing apparatus, Diablo Rina 1800 Marine	1082124

5 Chlorine Gas Metering Systems DULCO®Vaq

Compressed air cylinder

As replacement cylinder for compressed air breathing apparatus Diablo Rina 1800 (order no. 1082124).

	Order no.
Compressed air cylinder 6 litres – 300 bar steel	1082173

Protective gloves

	Order no.
Protective gloves 640 PVC, Size10 Cat.3	1082126

Chemical suit VS5 Polyran-L

One-part complete full-body chemical protective suit with fixed visor; gas-tight chemical protective suite with breathing air supply carried in the suit independent of the ambient air, i.e. a storage device with compressed air. Inclusive of gloves and safety boots.

Re-usable, washable, very good mechanical properties (tear-resistant, wear-resistant, puncture-resistant).

Certification: DIN EN 943 Part 1 –1a (Industry)

	Order no.
Chemical suit VS5 Polyran-L, yellow	1082509

5 Chlorine Gas Metering Systems DULCO®Vaq

5.11.5

Drum manifold accessories

Wall adapter for chlorine gas cylinders and chlorine gas drum

To wall mount the vacuum controller with semi-vacuum systems. Inclusive of flexible copper cable and connector valve.

	Connection	Order no.
Wall adapter for chlorine gas bottles PM3311	left	1059787
Wall adapter for chlorine gas bottles PM3311	right	1059789
Wall adapter for chlorine gas drum PM3312	left	1060304
Wall adapter for chlorine gas drum PM3312	right	1060308

Chlorine gas manifold and wall adapter

Chlorine gas manifold for the connection of multiple chlorine gas tanks to a common main line (for gaseous or liquid chlorine).

Chlorine gas manifold consisting of (quantities depending on the number of chlorine canisters):

- Main manifold line
- Manifold valves
- Flexible copper pipe
- Shut-off valves

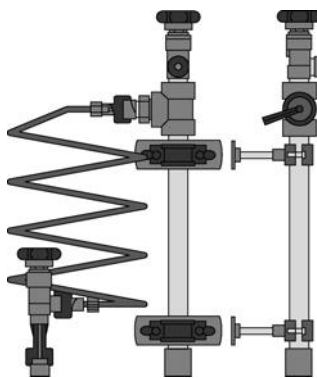

P_DV_0028_SW

	for connecting multiple cylinders	Connection	Order no.
Chlorine gas cylinder manifold PM3302 1"	2	left	1082573
Chlorine gas cylinder manifold PM3302 1"	2	right	1082584
Chlorine gas cylinder manifold PM3303 1"	3	left	1082585
Chlorine gas cylinder manifold PM3303 1"	3	right	1082586
Chlorine gas cylinder manifold PM3304 1"	4	left	1082588
Chlorine gas cylinder manifold PM3304 1"	4	right	1082589
Chlorine gas cylinder manifold PM3305 1"	5	left	1082590
Chlorine gas cylinder manifold PM3305 1"	5	right	1082591
Chlorine gas cylinder manifold PM3306 1"	6	left	1082592
Chlorine gas cylinder manifold PM3306 1"	6	right	1082593

	for connecting multiple drums	Connection	Order no.
Manifold for chlorine gas drum PM3322 1"	2	left	1075771
Manifold for chlorine gas drum PM3322 1"	2	right	1075772
Manifold for chlorine gas drum PM3323 1"	3	left	1082596
Manifold for chlorine gas drum PM3323 1"	3	right	1082597
Manifold for chlorine gas drum PM3324 1"	4	left	1082598
Manifold for chlorine gas drum PM3324 1"	4	right	1082599
Manifold for chlorine gas drum PM3325 1"	5	left	1082600
Manifold for chlorine gas drum PM3325 1"	5	right	1082601
Manifold for chlorine gas drum PM3326 1"	6	left	1082602
Manifold for chlorine gas drum PM3326 1"	6	right	1082603

Note: The right and left side of the manifold must be ordered if a switch-over is used.

Heating kit

Self-limiting heating band whose heat output decreases as the temperature rises. Output 15 W/m. incl. terminal kit and temperature sensor Pt100, length 10 m.

	Order no.
Complete heating set for chlorine gas manifold, 230 V	1082707

5

6 Storage Tanks

6.1 PE/PP Storage Tanks



Safe and reliable handling of chemicals.

Useful capacity 500 l–50,000 l, indoor and outdoor installation

Our plastic storage tanks guarantee compliance with statutory specifications taking into account country-specific approvals, which regulate the production and operation of systems for storage and metering of environmentally-hazardous substances.

Constructional design and production are in compliance with the construction and test guidelines as laid down by the German Institute for Building Technology (DIBT).

- Predominantly PE-HD and PP plate material is used, the suitable material being selected following checking of the chemical resistance and process-specific requirements.

Your benefits

- Predominantly PE-HD and PP plate material is used, the suitable material being selected following checking of the chemical resistance and process-specific requirements.

Field of application

Suitable for the storage of chemicals. Applications include: Potable water and process water treatment, process technology, waste water technology, electroplating, swimming pool technology and exhaust air treatment.

6.2 PE Storage Tank With General WHG Approval

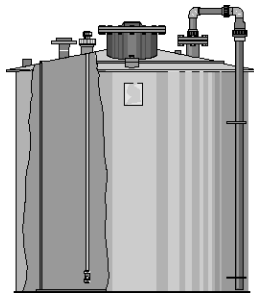

pk_3_014

The storage of chemicals hazardous for water (Water Hazard Class (WGK) 0-3) is subject to strict, regulatory requirements.

We supply storage tanks that comply with WHG §19 I, suitable for installation indoors and outdoors, up to a storage volume of 50 m³. The storage tanks are available with monitoring accessories, filling level devices, filling equipment, heating equipment, suction and dosing assemblies.

PE-HD Storage Tanks

- Approval mark Z-40.21-229 in compliance with the WHG § 19 (Water Resource Management Act)
- Design and manufacture carried out in accordance with the construction and test principles of the DIBT (German Institute of Building Technology)
- For pressure-free operation up to a max. working temperature of 30 °C
- Material: polyethylene PE-HD
- For indoor or outdoor installation
- For chemicals in accordance with the DIBT media list

Usable volume 95% fill level	Internal diameter	External diameter	Height of cylindrical section	Overall height	Weight empty
l	mm	mm	mm	mm	kg
500	800	860	1,050	1,300	50
750	1,000	1,060	1,050	1,300	60
1,000	1,000	1,060	1,350	1,600	70
1,250	1,200	1,260	1,150	1,400	80
1,500	1,200	1,260	1,400	1,650	90
2,000	1,400	1,480	1,400	1,650	100
2,500	1,400	1,480	1,700	1,950	130
3,000	1,600	1,680	1,550	1,800	170
3,500	1,700	1,780	1,550	1,800	190
4,000	1,700	1,780	1,850	2,100	220
5,000	1,900	1,980	1,850	2,100	280
6,000	2,000	2,080	1,950	2,250	350
7,000	2,150	2,250	1,950	2,250	400
8,000	2,150	2,250	2,250	2,550	500
10,000	2,150	2,250	2,900	3,200	600
12,000	2,150	2,250	3,400	3,700	700

Other sizes available on request.

6 Storage Tanks

PE-HD Collecting Pans

Usable volume 95% fill level	Internal diameter	External diameter	Height of cylindrical section	Overall height	Weight empty
l	mm	mm	mm	mm	kg
500	1,050	1,150	1,030	1,050	40
750	1,250	1,350	1,030	1,050	45
1,000	1,250	1,350	1,280	1,300	50
1,250	1,450	1,550	1,080	1,100	55
1,500	1,450	1,550	1,330	1,350	60
2,000	1,650	1,750	1,280	1,300	70
2,500	1,650	1,750	1,600	1,620	90
3,000	1,850	1,950	1,470	1,500	105
3,500	1,950	2,050	1,470	1,500	120
4,000	1,950	2,050	1,750	1,780	140
5,000	2,150	2,250	1,750	1,780	160
6,000	2,250	2,350	1,900	1,950	200
7,000	2,390	2,490	1,910	1,960	220
8,000	2,390	2,490	2,200	2,250	270
10,000	2,390	2,490	2,750	2,800	350
12,000	2,390	2,490	3,300	3,350	450

Other sizes available on request.

6 Storage Tanks

6.2.1

Our standard equipped storage tanks and collecting pans with approval marks

For indoor or outdoor installation; other internal fittings/accessories on request.

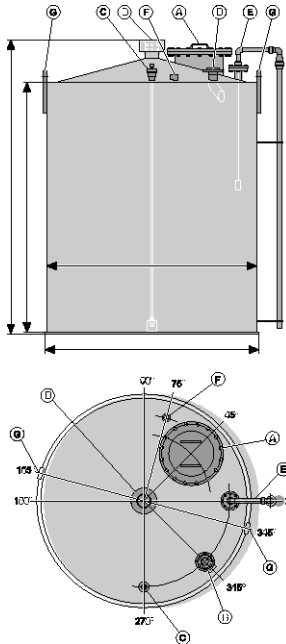

pk_3_046

Item	Quantity	Name	500 l - 1,250 l	1,500 l - 2,000 l	2,500 l - 3,500 l	4,000 l - 12,000 l
A	1	Handhole/manhole, bolted 1.4301	DN 250	DN 250	DN 500	DN 500
B	1	Filling connection with 45° inlet elbow	DN 32	DN 50	DN 50	DN 50
C	1	Sampling pipe PVC/EPDM	DN 15	DN 15	DN 15	DN 20
D	1	Vent pipe with dome	DN 80	DN 100	DN 100	DN 100
E	1	Rope-operated level indicator	DN 80/40	DN 80/40	DN 80/40	DN 80/40
F	1	Screwed socket for overfill protection	Rp 2"	Rp 2"	Rp 2"	Rp 2"
G	2	Crane lifting eye	-	yes	yes	yes

Collecting Pans for outdoor installation

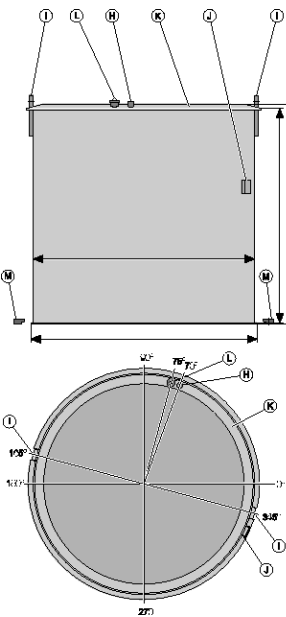

pk_3_047

Item	Quantity	Name	500 l - 1,250 l	1,500 l - 12,000 l
H	1	Leakage sensor support	Rp 2"	Rp 2"
I	2	Crane lifting eye	-	yes
J	1	Name plate	yes	yes
K	1	Rain collar	yes	yes
L	1	Inspection port	yes	yes
M	1	Floor claw set	yes	yes

Collecting Pans for indoor installation

Item	Quantity	Name	500 l - 1,250 l	1,500 l - 12,000 l
H	1	Leakage sensor support	Rp 2"	Rp 2"
I	2	Crane lifting eye	-	yes
J	1	Name plate	yes	yes

6 Storage Tanks

6.2.2

Accessories Meeting The Requirements Of WHG § 19 and VAWS (Directive On Systems For Storage And Handling Of Water-Endangering Substances)

Overfill protection with approval mark

T200 level gauge with float as max. level limit switch, without downstream transmitter, see below. Length 500 mm.

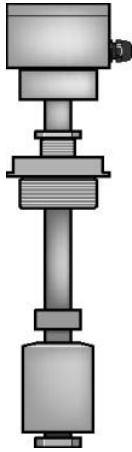

pk_3_037

	Order no.
Overfill protection with approval mark	1009334

Leakage sensor with approval mark

T200 leakage detection system consisting of level detector with float, without downstream transmitter, see below. Length 3,000 mm.

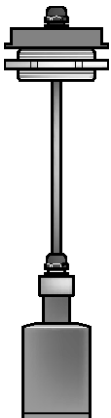

pk_3_038

	Order no.
Leakage sensor with approval mark	1009340

Transmitter with approval mark

For installation in control cabinets by others, suitable for leakage and overfill protection.

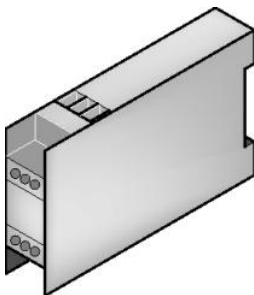

pk_3_040

	Order no.
Transmitter with approval mark	1009348

Alarm indicator unit

For overfill protection and leakage sensor with approval mark incl. beacon light, signal horn and two transmitters.

Price on request.

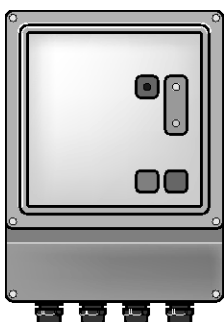

pk_3_039

6 Storage Tanks

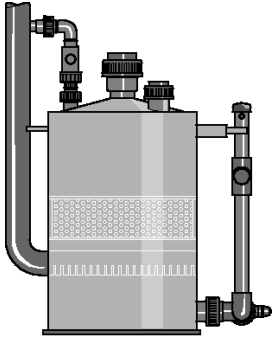

Absorption vessel

For ventilation of closed storage tanks.

Material: polyethylene PE-HD complete with connections, PVC/EPDM ball valve and fixed pipework to storage tank; sizes and prices according to tank volume and stored medium.

Price on request.

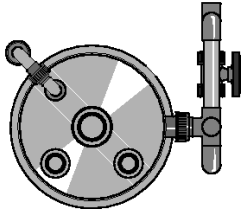

pk_3_041

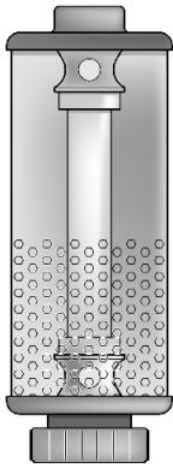

Acid vapour separator

Size and combining agent according to tank volume and stored medium.

Price on request.

pk_3_042

6 Storage Tanks

6.2.3

Other Accessories

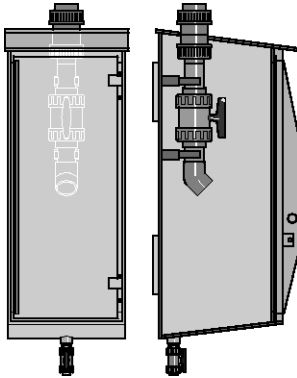

pk_3_043

Chemical filling station

Suitable for third-party wall mounting.

Material: polyethylene PE-HD.

Size: approx. 420x420x1000 mm (LxWxH), complete with DN 50 PVC/EPDM ball valve, threaded connector and drip tray with ball valve DN 25

PVC/EPDM connection: Rp 2" (parallel female thread)

Other built-in components such as tank waggon couplings, automatic valves, heater, etc. are possible; prices on request.

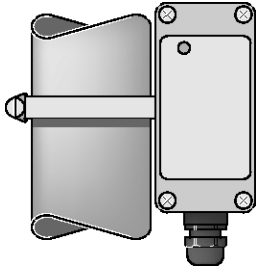

pk_3_044

Bistable changeover contact

With approval mark for fitting on rope-operated level indicator.

Bistable changeover contact

Order no.

1009349

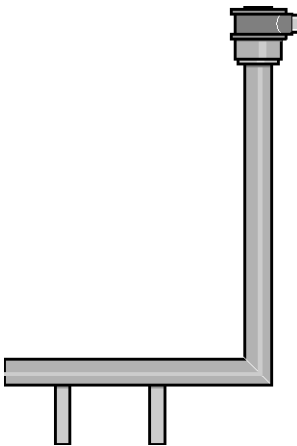

pk_3_045

Storage tank heater

With temperature and level control for run-dry protection; on request, according to stored medium and tank volume.

Optional in addition to insulation of the storage tank.

Price on request.

6 Storage Tanks

6.3 PP/PE Storage Tanks, Custom-built

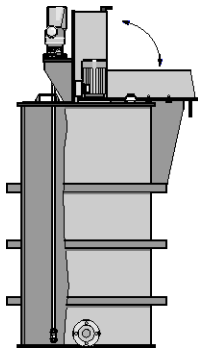

pk_3_015

System and process-technology requirements and specifications, and often special requirements demand specially tailored and custom-manufactured PP-PE storage tanks produced using special plate welding machines and bending machines.

Selection of a suitable plate material after checking its chemical resistance.

Additional inserts and attachments, like connecting nozzles, flanges, stirrers, salt dissolving baskets, bag dump equipment, absorption tanks, slanted and cone bottom, optimise and extend their functionality, permitting targeted adaptation of technical problems. A versatile programme of transducers and sensors can also be integrated.

We supply storage tanks up to a storage volume of 50 m³.

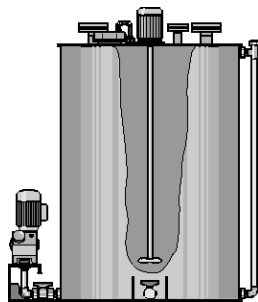

pk_3_016

Round Tanks

- Material: polyethylene PE-HD or polypropylene PP
- Bottom design: flat bottom, cone bottom, slanted bottom
- Roof design: flat roof, tapered roof or open, suitable for pressure-free operation at working temperatures of up to 80 °C
- Standard equipment: 2 crane lifting eyes on round tanks with usable volumes above 2000 litres
- Prices on request according to application

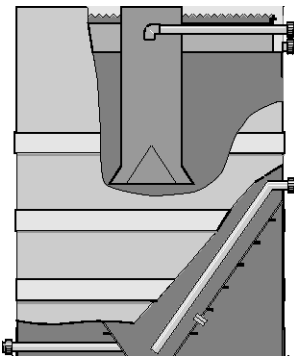

pk_3_017

Usable volume 95% fill level	Internal diameter	External diameter	Height of cylindrical section	Overall height
l	mm	mm	mm	mm
500	800	860	1,050	1,070
750	1,000	1,060	1,050	1,070
1,000	1,000	1,060	1,350	1,370
1,250	1,200	1,260	1,150	1,170
1,500	1,200	1,260	1,400	1,425
2,000	1,400	1,480	1,400	1,425
2,500	1,400	1,480	1,700	1,730
3,000	1,600	1,680	1,550	1,580
3,500	1,700	1,780	1,550	1,580
4,000	1,700	1,780	1,850	1,880
5,000	1,900	1,980	1,850	1,880
6,000	2,000	2,080	1,950	1,980
7,000	2,150	2,250	1,950	1,990
8,000	2,150	2,250	2,250	2,290
10,000	2,150	2,250	2,900	2,950
12,000	2,150	2,250	3,400	3,450

Other sizes available on request.

6 Storage Tanks

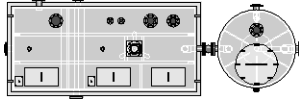
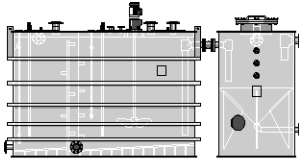

pk_3_048

Rectangular Tanks

- Material: polyethylene PE-HD or polypropylene PP
- Bottom design: flat bottom or slanted bottom, flat-mounted to foundation
- Roof design: flat roof or open, suitable for pressure-free operation at working temperatures of up to 80 °C
- Surrounding steel frame reinforcement, PE or PP coated
- Standard equipment: 4 crane lifting eyes on rectangular tanks with usable volumes above 2,000 litres.
- Prices on request according to application

Usable volume 95% fill level	Internal dimensions	External dimensions
	(L x W x H) mm	(L x W x H) mm
500	950 x 750 x 750	1,100 x 900 x 770
750	1,000 x 1,000 x 800	1,150 x 1,150 x 820
1,000	1,000 x 1,000 x 1,060	1,150 x 1,150 x 1,080
1,250	1,250 x 1,000 x 1,060	1,400 x 1,150 x 1,080
1,500	1,500 x 1,000 x 1,060	1,750 x 1,250 x 1,090
2,000	1,500 x 1,250 x 1,130	1,750 x 1,500 x 1,160
2,500	1,750 x 1,250 x 1,210	2,000 x 1,500 x 1,240
3,000	1,750 x 1,250 x 1,450	2,000 x 1,500 x 1,480
3,500	1,750 x 1,500 x 1,410	2,000 x 1,750 x 1,440
4,000	2,000 x 1,500 x 1,410	2,250 x 1,750 x 1,440
5,000	2,500 x 1,500 x 1,410	2,750 x 1,750 x 1,440
6,000	2,500 x 1,750 x 1,450	2,750 x 2,000 x 1,480
7,000	2,500 x 1,750 x 1,700	2,750 x 2,000 x 1,730
8,000	2,500 x 2,000 x 1,700	2,750 x 2,250 x 1,730
10,000	3,000 x 2,000 x 1,760	3,350 x 2,350 x 1,800
12,000	3,500 x 2,000 x 1,810	3,850 x 2,350 x 1,850
15,000	4,000 x 2,000 x 2,000	4,350 x 2,350 x 2,050

Other sizes available on request.

7 Polymer preparation and metering systems

Ultromat®, PolyRex and POLYMORE

7.1

Polyelectrolytes in Water Treatment

The use of polyelectrolytes as flocculation aids is characterised by an extensive field of applications. They can be used in all applications where colloidal solids need to be economically separated from liquids.

Our preparation and metering systems have been designed specifically for the production of ordinary or standard solutions of synthetic polyelectrolytes in powdered or liquid form and have proved themselves many times over.

The experts in waste water treatment at ProMinent understand how to provide the efficient technology to implement this specialist application. They have developed systems for the most stringent requirements, which are also very easy to assemble and operate.

ProMinent also provides all the advice needed for the efficient operation of a polymer batching and metering system:

- Evaluation of the situation on site by trained, expert field sales staff.
- Project planning of the system.
- Commissioning and system maintenance by our trained service technicians.

7 Polymer preparation and metering systems Ultromat[®], PolyRex and POLYMORE

7.2 Performance overview of polymer preparation and metering systems Ultromat[®], PolyRex and POLYMORE

ProMinent offers a wide range of systems for the most diverse preparation and metering applications. The following overview shows the capacity ranges of our type series:

Continuous Flow System

	Extraction rate l/h concentration max. 0.5 %	Application	Characteristic
ULFa ■ Powder ■ Liquid	400 – 8,000 (maturation period 60 min., starts with preparation)	<ul style="list-style-type: none"> ■ Potable water treatment ■ Waste water treatment (industry and local authorities) ■ Sludge de-watering 	<ul style="list-style-type: none"> ■ Simple screw feeder with good dosing precision proportional to water intake ■ Functionally simple mixing system with/without wetting cone ■ PP tank in 3-chamber arrangement

Batch preparation stations

	Extraction rate l/h concentration max. 0.5 %	Application	Characteristic
ULDa ■ Powder ■ Liquid	400 – 2,000 (maturation period 60 min., starts with preparation)	<ul style="list-style-type: none"> ■ Potable water treatment ■ Waste water treatment (industry and local authorities) ■ Sludge de-watering ■ Paper production 	<ul style="list-style-type: none"> ■ Simple screw feeder with good dosing precision proportional to water intake ■ Functionally simple mixing system with/without wetting cone ■ PP tank in double-deck arrangement
PolyRex ■ Powder ■ Liquid	240 – 8,200 (maturation period 45 min., starts after metering)	<ul style="list-style-type: none"> ■ Potable water treatment ■ Waste water treatment (industry and local authorities) ■ Sludge de-watering ■ Paper production 	<ul style="list-style-type: none"> ■ Multi-screw feeder with high dosing precision ■ Special wetting system with water ejector for effective powder hydration ■ Stainless steel tanks in double-deck arrangement ■ Integrated Big Bag emptying system
PolyRex Liquid ■ Liquid	1,060 – 3,180 (maturation period 15 min., starts after metering)	<ul style="list-style-type: none"> ■ Waste water treatment (industry and local authorities) ■ Sludge de-watering 	<ul style="list-style-type: none"> ■ High-energy mixing ■ Stainless steel tanks
MT ■ Powder	140 – 4,000	<ul style="list-style-type: none"> ■ Potable water treatment ■ Waste water treatment (industry and local authorities) ■ Sludge de-watering 	<ul style="list-style-type: none"> ■ for manual preparation mode ■ simplest mixing system ■ PP tanks

In-line preparation station

	Extraction rate l/h concentration max. 0.5 %	Application	Characteristic
POLYMORE ■ Liquid	120 – 18,000 (maturation period 0.75 – 3.5 min.)	<ul style="list-style-type: none"> ■ Potable water treatment ■ Waste water treatment (industry and local authorities) ■ Sludge de-watering 	<ul style="list-style-type: none"> ■ Pressure-encapsulated multi-zone mixing unit with peristaltic pump ■ Highly compact design ■ Wall-mounting ■ Simple commissioning

Oscillating system

	Extraction rate l/h concentration max. 0.5 %	Application	Characteristic
ULPa ■ Powder ■ Liquid	400 – 4,000 (maturation period 60 min., starts with preparation)	<ul style="list-style-type: none"> ■ Potable water treatment ■ Paper production 	<ul style="list-style-type: none"> ■ Simple screw feeder with good dosing precision proportional to water intake ■ Functionally simple mixing system with wetting cone ■ Preparation system with 2 PP tanks

7 Polymer preparation and metering systems Ultromat®, PolyRex and POLYMORE

7.3 Questionnaire for the design of polymer preparation and metering systems Ultromat®, PolyRex and POLYMORE

For the treatment of

- Potable water
- Waste water
- Sludge
- Paper
- _____

Polymer available as

- Powdered polymer
- Liquid polymer
- Required maturing time: _____

Required quantities

- Concentration of prepared solution: _____
- Max. metering quantity (volume of polymer): _____
- Required maturing time: _____

Quality of dilution water

- Potable water
- Process water

Mains voltage supply

- 400 VAC/50/60 Hz
- 440 VAC/60 Hz
- 460 VAC/60 Hz
- Other: _____

Other requirements

PRO01_0285_Fragebogen

7 Polymer preparation and metering systems

Ultromat®, PolyRex and POLYMORE

7.4

Preparation stations and metering of powdered and liquid polymer solutions Ultromat®

Preferred fields of application include:

- Potable water treatment
- Waste water treatment (industry and local authorities)
- Sludge de-watering
- Paper production

3 different automatic system concepts are available:

- Continuous flow system (identity code ULFa)
- Oscillating system (identity code ULPa)
- Double-decker system (identity code ULDa)

The systems differ primarily due to the construction of the storage tank. The storage tank in the continuous flow system is sub-divided into 3 chambers, largely preventing the mixing of fresh and matured polymer. Oscillating and double-deck systems are designed with two completely separate storage tanks. This prohibits the mixing of fresh and matured polymer.

Powder feeder units and liquid concentrate pumps can be freely selected by means of the identity code. Powdered or liquid polymers can therefore be prepared depending on the application.

Ultromat® unit types ULFa, ULPa and ULDa are equipped with a PLC Programmable Logic Controller (compact) and touch panel. Optionally the PLC compact controller can be fitted with a PROFIBUS®, Modbus or PROFINET module. Input of the solvent concentration, as well as calibration of the powder feeder unit and liquid concentrate pump is user-managed. Alarm messages and warnings are shown on the display. The feed of dilution water is continuously detected by a flow meter and shown on the display. The control calculates the polymer requirement based on the set solvent concentration and proportionately controls the powder feeder unit or concentrate pump so that the concentration of polymer solution is always kept constant even if there are fluctuations in the water supply.

7.4.1

Application example for a ULFa polymer preparation system

- Powder feeder
- Redilution
- Chemical transfer pump
- Powder Storage Vessel
- Big Bag handling
- Ultromat® ULFa

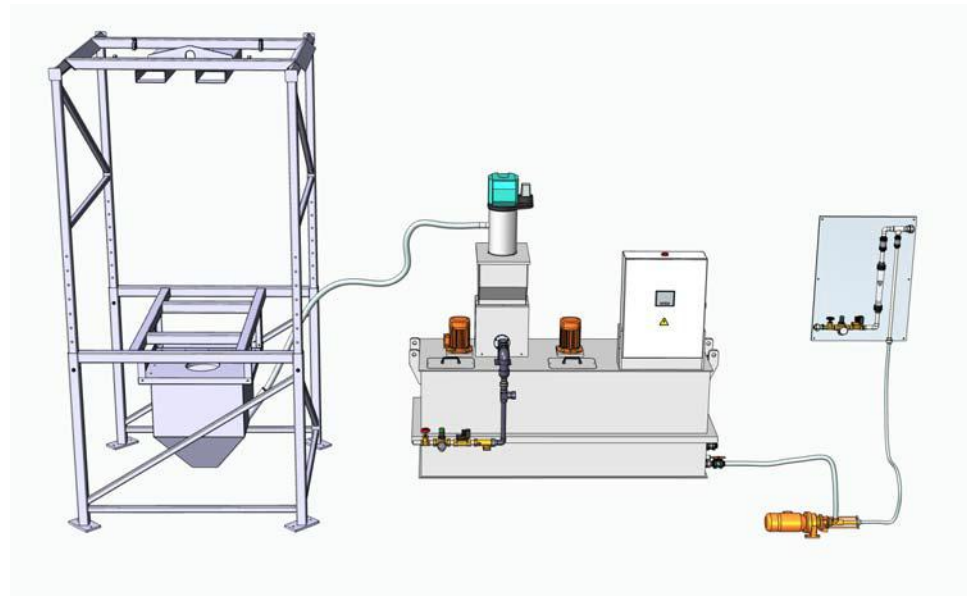

AP_0014_SW

7 Polymer preparation and metering systems Ultromat®[®], PolyRex and POLYMORE

7.5 Metering System Ultromat® ULFa



Efficient production of a polymer solution with a high throughput capacity.

Extraction rates of up to 8,000 l/h

Polymer batching station Ultromat® ULFa (continuous flow system): This metering system can be used to batch flocculation aids for the preparation of a ready-to-use polymer solution. The system was designed for the fully automatic batching of polymer solutions.

These systems can be used to process both liquid and powdered polymers. The storage tank, which is subdivided into three chambers, largely prevents the carry-over of the freshly batched polymer.

Your benefits

- Processing of liquid polymers (0.05 – 1.0 %) and powdered polymers (0.05 – 0.5 %)
- Minimal carry-over of product and thus higher-quality results
- Extraction of the polymer solution and drainage of the chambers through the front of the storage tank
- User-managed input of the solvent concentration and calibration of powder feeder unit and liquid concentrate pump
- Gentle mixing of the polymer solution (electric stirrer)
- Pressure sensor for the measurement of the liquid level
- Version with terminal box available on request

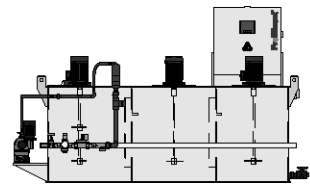

P_UL_0024_SW1

Ultromat® ULFa for liquid polymers

Technical Details

Siemens S7 – 1200 compact control system and KTP 400 touch panel

- Optionally fitted with PROFIBUS® and DP/DP coupler
- Optionally fitted with Profinet and PN/PN coupler
- Optionally fitted with Modbus TCP

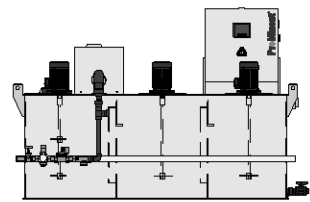

P_UL_0022_SW1

Ultromat® ULFa for powder polymers

Field of application

- Potable water treatment
- Waste water treatment (industry and local authorities)
- Sludge de-watering

The following types of polymer can be processed:

- Liquid polymers (0.05 – 1.0 %)
- Powdered polymers (0.05 – 0.5%)

Selectable components:

- Tank size/ extraction rate
- Construction (normal or mirror image)
- Electrical connection
- Control S7 – 1200 (with and without PROFIBUS®/PROFINET/Modbus TCP)
- Powder feeder
- Vibrator for powder feeder (promotes the movement of polymer)
- Powder feeder unit FG205/ top hopper (for filling and feeding the powder feeder)
- Liquid concentrate pumps in the Sigma, Spectra, DULCO®flex ranges
- Monitor for liquid concentrate pump (float switch / flow monitor)
- Flush valve (Y-flush inlet or wetting cone)
- Stirrer for 3rd chamber
- Language (pre-set language for the control panel)

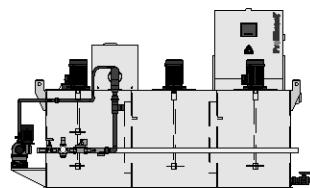

P_UL_0023_SW1

Ultromat® ULFa for powder and liquid polymers

The standard scope of delivery includes among other things:

- Pause function/ operating message/ empty running function
- Monitoring of the re-dilution unit
- Lifting lugs for transport

7 Polymer preparation and metering systems Ultromat®, PolyRex and POLYMORE

Technical Data

Discharge volume	l/h	400	1,000	2,000	4,000	6,000	8,000
Tank volume	l	400	1,000	2,000	4,000	6,000	8,000
Diluent water max.	l/h	600	1,500	3,000	6,000	9,000	12,000
Water pressure	bar	3 – 5	3 – 5	3 – 5	3 – 5	3 – 5	3 – 5
Powdered polymer	kg/h	0.5–11	0.5–11	0.8–18	3.6–55	3.6–55	4.8–110
Length	mm	1,999	2,643	3,292	3,301	4,120	4,605
Width	mm	918	1,002	1,186	1,456	1,651	1,910
Height	mm	1,390	1,740	1,890	2,182	2,182	2,290
Water connection	"	1	1	1	1 1/2	1 1/2	2
Discharge nozzle DN	mm	25	25	32	40	40	50
Concentrate feed DN	mm	15	15	15	20	20	20
Voltage / frequency	V/Hz	400/50 460/60	400/50 460/60	400/50 460/60	400/50 460/60	400/50 460/60	400/50 460/60
Power uptake	kW	1.5	2.6	3.2	5.0	5.0	9.5

7 Polymer preparation and metering systems Ultromat[®], PolyRex and POLYMORE

7.5.1 Identity Code Ordering System for Continuous Flow Systems Ultromat[®] ULFa

ULFa	Type / Tank size / Discharge volume
0400	Continuous flow system / 400 l / 400 l/h 4000 Continuous flow system / 4000 l / 4000 l/h
1000	Continuous flow system / 1000 l / 1000 l/h 6000 Continuous flow system / 6000 l / 6000 l/h
2000	Continuous flow system / 2000 l / 2000 l/h 8000 Continuous flow system / 8000 l / 8000 l/h
Design	
N	standard
S	mirror-imaged
Electrical connection	
A	400 VAC, 50/60 Hz (3ph, N, PE)
B	440 VAC, 60 Hz (3 ph, N, PE)
C	460 VAC, 60 Hz (3 ph, N, PE)
Control	
0	PLC S7-1200
1	PLC S7-1200 with PROFIBUS [®] (DP/DP coupler)
2	PLC Programmable Logic Controller S7-1200 with PROFINET (PN/PN coupler)
3	PLC Programmable Logic Controller S7 – 1200 with MODBUS TCP
Options	
0	none
1	Discharge pipework, PVC (400, 1000)
2	Discharge pipework, PVC (2000)
3	Discharge pipework, PVC (4000, 6000)
4	Discharge pipework, PVC (8000)
Powder feeder	
P0	none
P1	Powder feeder (0400, 1000)
P2	Powder feeder (2000)
P3	Powder feeder (4000, 6000)
P4	Powder feeder (8000)
Vibrator for powder feeder	
0	none
1	with vibrator for powder feeder
Powder conveyor FG 205, add-on hopper	
0	none
1	with add-on hopper 50 l (0400, 1000, 2000)
2	with add-on hopper 75 l (4000, 6000)
3	with add-on hopper 100 l (8000)
4	with add-on hopper 50 l + powder conveyor unit FG205 (0400, 1000, 2000)
5	with add-on hopper 75 l + powder conveyor unit FG205 (4000, 6000)
6	with add-on hopper 100 l + powder conveyor unit FG205 (8000)
7	with adapter cover + powder conveyor unit FG205
Liquid concentrate pump	
L0	none
L1	with Sigma
L2	with Spectra
L3	prepared for Sigma
L4	prepared for Spectra
L5	prepared for Sigma, no bracket
L6	prepared for Spectra, no bracket
L7	prepared for peristaltic pump
L8	with peristaltic pump
Monitoring for liquid concentrate pump	
0	none
1	with float switch for concentrate tank
2	with flow monitor (only Spectra)
3	with float switch and flow monitor (only Spectra)
Water pipework with wetting fitting	
1	Y-wetting fitting, PVC (0400, 1000, 2000)
2	Y-wetting fitting, PVC (4000, 6000)
3	Y-wetting fitting, PVC (8000)
4	Wetting cone, PVC (0400, 1000, 2000)
5	Wetting cone, PVC (4000, 6000)
6	Wetting cone, PVC (8000)
7	Wetting cone, PP (0400, 1000, 2000)
8	Wetting cone, PP (4000, 6000)
9	Wetting cone, PP (8000)
Stirrer for 3rd chamber	
0	none
1	Stirrer for storage tank 400, 0.18 kW, 400-440 VAC
2	Stirrer for storage tank 1000, 0.55 kW, 400-440 VAC
3	Stirrer for storage tank 2000, 0.75 kW, 400-440 VAC
4	Stirrer for storage tank 4000/6000, 1.1 kW, 400-440 VAC
5	Stirrer for storage tank 8000, 2.2 kW, 400-440 VAC
A	Stirrer for storage tank 400, 0.21 kW, 460 VAC
B	Stirrer for storage tank 1000, 0.65 kW, 460 VAC
C	Stirrer for storage tank 2000, 0.9 kW, 460 VAC
D	Stirrer for storage tank 4000/6000, 1.3 kW, 460 VAC
E	Stirrer for storage tank 8000, 2.6 kW, 460 VAC
Language	
BG	bulgarian
CN	chinese
CZ	czech
DA	danish
DE	german
EL	greek
EN	english
ES	spanish
ET	estonian
FI	finnish
FR	french
HR	croatian
HU	hungarian
IT	italian
LT	lithuanian
LV	latvian
MS	malay
NL	dutch
NO	norwegian
PL	polish
PT	portuguese
RO	romanian
RU	russian
SK	slovakian
SL	slovenian
SV	swedish
TR	turkish

7 Polymer preparation and metering systems Ultromat®, PolyRex and POLYMORE

7.6 Metering System Ultromat® ULPa

A good solution when preparing polymer solutions as flocculation aids.

Extraction rates from 400 to 4,000 l/h



The metering system Ultromat® ULPa (oscillating system) is ideal for batching flocculation aids for the preparation of a ready-to-use polymer solution.

Ultromat® ULPa units consist of two separate chambers, which can be successively filled with polymer solution, eliminating the risk of product carry-over. Both liquid and powdered polymers can be processed depending on the product range.

Your benefits

- Processing of liquid polymers (0.05 - 1.0 %) and powdered polymers (0.05 - 0.5 %)
- No mixing of fresh and matured polymer
- Operator-controlled input of solvent concentration and calibration of powder feeder and liquid concentrate pump
- Gentle mixing of the polymer solution (electric stirrer)
- Pressure sensor for the measurement of the liquid level
- Version with terminal box available on request

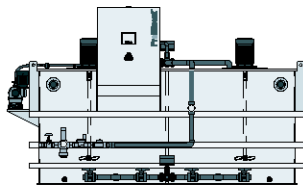

P_UL_0026_SW1
Ultromat® ULPa for liquid polymers

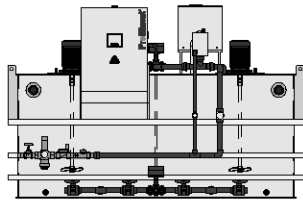

P_UL_0027_SW1
Ultromat® ULPa for powder polymers

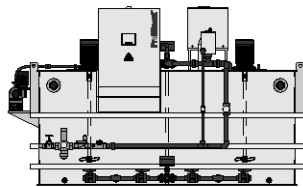

P_UL_0028_SW1
Ultromat® ULPa for powder and liquid polymers

Technical Details

Siemens S7 – 1200 compact control system and KTP 400 touch panel

- Optionally fitted with PROFIBUS® and DP/DP coupler
- Optionally fitted with PROFINET and PN/PN coupler
- Optionally fitted with Modbus TCP

Field of application

- Potable water treatment
- Paper production

The following types of polymer can be processed:

- Liquid polymers (0.05 – 1.0 %)
- Powdered polymers (0.05 – 0.5 %)

Selectable components:

- Tank size/extraction rate
- Construction (normal or mirror image)
- Electrical connection
- Control S7 – 1200 (with and without PROFIBUS®/PROFINET/Modbus TCP)
- Powder feeder
- Vibrator for powder feeder unit (promotes the movement of polymer)
- FG205 powder feeder/top hopper (for filling and feeding the powder feeder unit)
- Liquid concentrate pumps of types Sigma, Spectra, DULCO®flex
- Monitor for liquid concentrate pump (float switch / flow monitor)
- Flush valve
- Language (pre-set language for the control panel)

The standard scope of delivery includes among other things:

- Pause function/operating message/running dry function
- Monitoring of the re-dilution unit
- Lifting lugs for transport

7 Polymer preparation and metering systems Ultromat[®], PolyRex and POLYMORE

Technical Data

Discharge volume	l/h	400	1,000	2,000	4,000
Tank volume	l	2 x 400	2 x 1,000	2 x 2,000	2 x 4,000
Diluent water max.	l/h	1,600	4,000	8,000	14,000
Water pressure	bar	3 – 5	3 – 5	3 – 5	3 – 5
Powdered polymer	kg/h	0.5–11	0.8–18	3.6–55	4.8–110
Length	mm	2,040	2,840	3,340	4,540
Width	mm	1,253	1,733	1,918	2,583
Height	mm	1,635	1,739	2,178	2,384
Water connection	"	1	1 1/4	1 1/2	2
Discharge nozzle DN	mm	25	32	40	50
Concentrate feed DN	mm	15	15	20	20
Voltage/Frequency	VAC/Hz	400/50	400/50	400/50	400/50
Power uptake	kW	2.5	3.2	5.5	7.0

7 Polymer preparation and metering systems Ultromat®, PolyRex and POLYMORE

7.6.1 Identity Code Ordering System for Oscillating Systems Ultromat® ULPa

ULPa	Type / Tank size / Discharge volume
0400	Oscillating system / 2x400 l / 400 l/h
1000	Oscillating system / 2x1,000 l / 1,000 l/h
2000	Oscillating system / 2x2,000 l / 2,000 l/h
4000	Oscillating system / 2x4,000 l / 4,000 l/h
Construction	
N	standard
S	mirror-imaged
Electrical connection	
A	400 VAC, 50/60 Hz (3ph, N, PE)
Control	
0	PLC S7-1200
1	PLC S7-1200 with PROFIBUS® (DP/DP coupler)
2	PLC Programmable Logic Controller S7-1200 with PROFINET (PN/PN coupler)
3	PLC Programmable Logic Controller S7 – 1200 with MODBUS TCP
Options	
0	none
Powder feeder	
P0	none
P1	Powder feeder (0400)
P2	Powder feeder (1000)
P3	Powder feeder (2000)
P4	Powder feeder (4000)
Vibrator for powder feeder	
0	none
1	with vibrator for powder feeder
Powder conveyor FG205, add-on hopper	
0	none
1	with add-on hopper 50 l (0400, 1000)
2	with add-on hopper 75 l (2000)
3	with add-on hopper 100 l (4000)
4	with add-on hopper 50 l + powder conveyor unit FG205 (0400, 1000)
5	with add-on hopper 75 l + powder conveyor unit (2000)
6	with add-on hopper 100 l + powder conveyor unit (4000)
7	with adapter cover + powder conveyor unit
Liquid concentrate pump	
L0	none
L1	with Sigma
L2	with Spectra
L3	prepared for Sigma
L4	prepared for Spectra
L5	prepared for Sigma, no bracket
L6	prepared for Spectra, no bracket
L7	prepared for peristaltic pump
L8	with peristaltic pump
Monitor for liquid concentrate pump	
0	none
1	with float switch for concentrate tank
2	with flow monitor (only Spectra)
3	with float switch and flow monitor (only Spectra)
Water pipework with wetting fitting	
0	without wetting cone (liquid version)
1	Wetting cone, PVC (0400)
2	Wetting cone, PVC (1000, 2000)
3	Wetting cone, PVC (4000)
4	Wetting cone, PP (0400)
5	Wetting cone, PP (1000, 2000)
6	Wetting cone, PP (4000)
Language	
BG	bulgarian
CN	chinese
CZ	czech
DA	danish
DE	german
EL	greek
EN	english
ES	spanish
ET	estonian
FI	finnish
FR	french
HR	croatian
HU	hungarian
IT	italian
LT	lithuanian
LV	latvian
MS	malay
NL	dutch
NO	norwegian
PL	polish
PT	portuguese
RO	romanian
RU	russian
SK	slovakian
SL	slovenian
SV	swedish
TR	turkish

7

7 Polymer preparation and metering systems Ultromat®, PolyRex and POLYMORE

7.7 Metering System Ultromat® ULDa

A good solution when preparing polymer solutions as flocculation aids.

Extraction rates of up to 2,000 l/h

The ProMinent metering system Ultromat® ULDa is an automatic polyelectrolyte preparation system. It is useful wherever polymers need to be automatically prepared as polymer solutions to act as flocculation aids.



Ultromat® ULDa double-decker systems are used to process liquid and powdered polymers. The system consists of two separate PP storage tanks, stacked above each other, preventing product carry-over. The polymer solution is batched in the upper storage tank and can be transferred to the lower storage tank once the maturing time has elapsed.

Your benefits

- Processing of liquid polymer (0.05 – 1.0 %) and powdered polymers (0.05 – 0.5 %)
- No mixing of fresh and matured polymer
- Wide range of versions for specific applications
- Operator-controlled input of solvent concentration and calibration of powder feeder and liquid concentrate pump
- Water apparatus with flow meter and fitting set for the dilution water
- Gentle mixing of the polymer solution (electric stirrer)
- Pressure sensor for the measurement of the liquid level
- Version with terminal box available on request

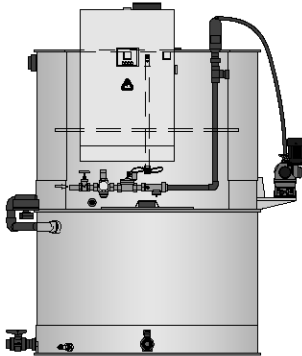

P_UL_0029_SW1
Ultromat® ULDa for liquid polymers

Technical Details

Siemens S7 – 1200 compact control system and KTP 400 touch panel

- PLC Programmable Logic Controller optionally fitted with PROFIBUS® and DP/DP coupler
- Optionally fitted with Profinet and PN/PN coupler
- Optionally fitted with Modbus TCP

Field of application

- Potable water treatment
- Waste water treatment (industry and local authorities)
- Sludge de-watering
- Paper production

The following types of polymer can be processed:

- Liquid polymers (0.05 – 1.0 %)
- Powdered polymers (0.05 – 0.5 %)

Selectable components:

- Tank size/extraction rate
- Construction (normal or mirror image)
- Electrical connection
- Control S7 – 1200 (with and without PROFIBUS®/PROFINET/Modbus TCP)
- Powder feeder
- Vibrator for powder feeder unit (promotes the movement of polymer)
- FG205 powder feeder/top hopper (for filling and feeding the powder feeder unit)
- Liquid concentrate pumps of types Sigma, Spectra, DULCOflex
- Monitor for liquid concentrate pump (float switch / flow monitor)
- Flush valve (Y-flush inlet or wetting cone)
- Language (pre-set language for the control panel)

The standard scope of delivery includes among other things:

- Pause function/operating message/running dry function
- Monitoring of the re-dilution unit
- Lifting lugs

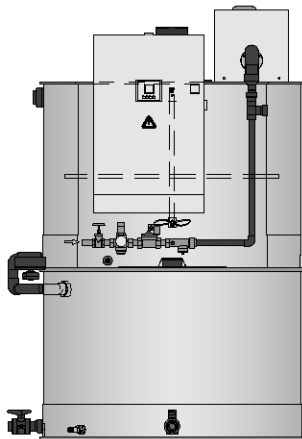

P_UL_0030_SW1
Ultromat® ULDa for powder polymers

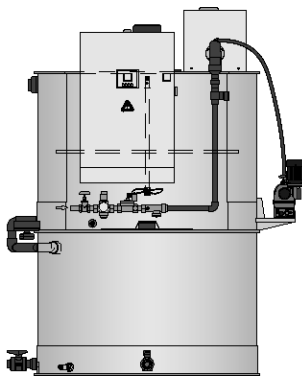

P_UL_0031_SW1
Ultromat® ULDa for powder and liquid polymers

7 Polymer preparation and metering systems Ultromat®, PolyRex and POLYMORE

Technical Data

Discharge volume	l/h	400	1,000	2,000
Tank volume	l	2 x 400	2 x 1,000	2 x 2,000
Diluent water max.	l/h	1,600	4,000	8,000
Water pressure	bar	3 – 5	3 – 5	3 – 5
Powdered polymer	kg/h	0.5–11	0.8–18	3.6–55
Length	mm	1,638	1,902	2,288
Width	mm	1,351	1,615	2,005
Height	mm	2,030	2,514	3,149
Water connection	"	1	1 1/4	1 1/2
Discharge nozzle DN	mm	25	32	40
Concentrate feed DN	mm	15	15	20
Voltage/Frequency	VAC/Hz	400/50	400/50	400/50
Power uptake	kW	1.5	2.6	3.2

7 Polymer preparation and metering systems

Ultromat[®], PolyRex and POLYMORE

7.7.1 Identity Code Ordering System for Double-deck System Ultromat[®] ULDa

ULDa	Type / Tank size / Discharge volume
	0400 Double-deck system / 2x400 l / 400 l/h
	1000 Double-deck system / 2x1,000 l / 1,000 l/h
	2000 Double-deck system / 2x2,000 l / 2,000 l/h
Construction	
N	standard
S	mirror-imaged
Electrical connection	
A	400 VAC, 50/60 Hz (3ph, N, PE)
Control	
0	PLC S7-1200
1	PLC S7-1200 with PROFIBUS [®] (DP/DP coupler)
2	PLC Programmable Logic Controller S7-1200 with PROFINET (PN/PN coupler)
3	PLC Programmable Logic Controller S7 – 1200 with MODBUS TCP
Options	
0	none
Powder feeder	
P0	none
P1	Powder feeder (0400)
P2	Powder feeder (1000)
P3	Powder feeder (2000)
Vibrator for powder feeder	
0	none
1	with vibrator for powder feeder
Powder conveyor FG205, add-on hopper	
0	none
1	with add-on hopper 50 l
2	with add-on hopper 75 l
3	with add-on hopper 100 l
4	with add-on hopper 50 l + powder conveyor unit
5	with add-on hopper 75 l + powder conveyor unit
6	with add-on hopper 100 l + powder conveyor unit
7	with adapter cover + powder conveyor unit
Liquid concentrate pump	
L0	none
L1	with Sigma
L2	with Spectra
L3	prepared for Sigma
L4	prepared for Spectra
L5	prepared for Sigma, no bracket
L6	prepared for Spectra, no bracket
L7	prepared for peristaltic pump
L8	with peristaltic pump
Monitor for liquid concentrate pump	
0	none
1	with float switch for concentrate tank
2	with flow monitor (only Spectra)
3	with float switch and flow monitor (only Spectra)
Water pipework with wetting fitting	
1	Y-wetting fitting, PVC (0400)
2	Y-wetting fitting, PVC (1000)
3	Y-wetting fitting, PVC (2000)
4	Wetting cone, PVC (0400)
5	Wetting cone, PVC (1000)
6	Wetting cone, PVC (2000)
7	Wetting cone, PP (0400)
8	Wetting cone, PP (1000)
9	Wetting cone, PP (2000)
Language	
BG	bulgarian
CN	chinese
CZ	czech
DA	danish
DE	german
EL	greek
EN	english
ES	spanish
ET	estonian
FI	finnish
FR	french
HR	croatian
HU	hungarian
IT	italian
LT	lithuanian
LV	latvian
MS	malay
NL	dutch
NO	norwegian
PL	polish
PT	portuguese
RO	romanian
RU	russian
SK	slovakian
SL	slovenian
SV	swedish
TR	turkish

7 Polymer preparation and metering systems Ultromat®, PolyRex and POLYMORE

7.8

Metering System Ultromat® MT for Batch Operation

This manual polymer batching station is worthwhile if you only work with small quantities.

Capacity range 120 – 3,800 l/h

Manual polymer batching station Ultromat® MT: Perfect metering system for the processing of small quantities of liquid and powdered polymers: extremely robust and cost-effective.

The Ultromat® MT is ideal for individually batching polymer solutions where there is no need for automatic operation. The powdered polymer is added manually through the wetting cone to the maturing tank and mixed by the stirrer. After the maturing time, the flocculant solution can then be metered into the application.

Your benefits

- Ideal for use where there is no need for continuous operation
- Manual addition of flocculants
- Robust and cost-effective
- Round polypropylene batching tank
- Flushing system with wetting cone and injector
- Gentle mixing of the polymer solution

Technical Details

- Slowly-running stirrer
- Flushing system
- Level switch (Low flow, Min, Max contact)
- Terminal box

Field of application

- Potable water treatment
- Waste water treatment (industry and local authorities)
- Sludge de-watering

The systems consist of:

- 1 PP batching tank
- 1 Flushing system for flushing and wetting the powder with wetting cone, injector and fitting set for the dilution water
- 1 Slow-running electric stirrer
- 1 Level switch with three switching points
- 1 Terminal box

Ultromat® MT

	Order no.
MT 140, stirrer 0.18 kW	1037073
MT 250, stirrer 0.55 kW	1037094
MT 500, stirrer 0.75 kW	1037095
MT 1000, stirrer 1.1 kW	1037096
MT 2000, stirrer 2.2 kW	1037097
MT 3000, stirrer 2.2 kW	1037098
MT 4000, stirrer 3 kW	1037099

Technical Data

Type		MT 140	MT 250	MT 500	MT 1000	MT 2000	MT 3000	MT 4000
Discharge volume	l/h	120	210	440	920	1,890	2,850	3,800
Tank volume	l	120	210	440	920	1,890	2,850	3,800
Diameter of tank	mm	640	650	850	1,260	1,460	1,770	1,650
Height of tank	mm	714	1,116	1,018	1,016	1,518	1,620	2,072
Height	mm	1,003	1,405	1,309	1,320	1,875	1,998	2,496
Water connection DN	mm	20	20	20	25	32	40	40
Discharge nozzle DN	mm	20	20	20	25	32	40	40
Voltage/Frequency	VAC/Hz	400/50	400/50	400/50	400/50	400/50	400/50	400/50
Power uptake	kW	0.18	0.55	0.75	1.10	2.20	2.20	3.00

The systems are also available with flushing water fitting, level indicator and switchgear.

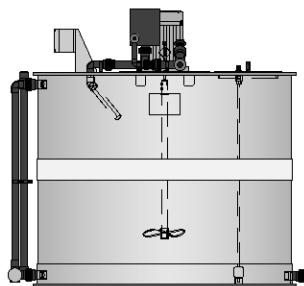

P_UL_0025_SW1

7 Polymer preparation and metering systems Ultromat®, PolyRex and POLYMORE

7.9 Ultromat® accessories including Big Bag systems

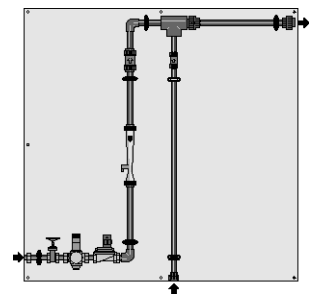

pk_7_030

Ultromat® VS dilution unit

Ultromat® dilution units are pre-assembled turnkey units for the dilution of polymer solutions, essentially comprising:

- 1 Water fitting for the dilution water with manual stop tap, pressure release valve, solenoid valve 24 V DC and flow meter float including minimum contact
- 1 Pipe for the polymer solution to be diluted including non-return valve
- 1 Static mixer for mixing stock solution with the dilution water

	Process solution	Order no.
VS 1000	1,000 l/h	1021386
VS 2000	2,000 l/h	1021387
VS 5000	5,000 l/h	1021388
VS 10000	10,000 l/h	1021389
VS 20000	20,000 l/h	1021390
VS 30000	30,000 l/h	1021391
VS 50000	50,000 l/h	1021392

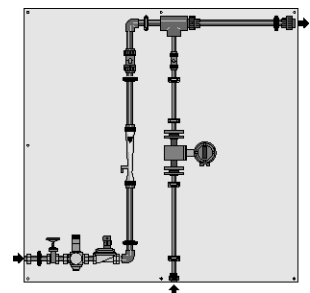

pk_7_031

Ultromat® VS-IP dilution unit with flow meter

The Ultromat® dilution units are pre-assembled turnkey units for the dilution of polymer solutions, essentially comprising:

- 1 Water fitting for the dilution water with manual stop tap, pressure release valve, solenoid valve 24 V DC and flow meter float including minimum contact
- 1 Pipe for the polymer solution to be diluted including non-return valve and inductive flow meter
- 1 Static mixer for mixing stock solution with the dilution water

	Process solution	Order no.
VS 1000 IP	1,000 l/h	1021490
VS 2000 IP	2,000 l/h	1021491
VS 5000 IP	5,000 l/h	1021492
VS 10000 IP	10,000 l/h	1021493
VS 20000 IP	20,000 l/h	1021494
VS 30000 IP	30,000 l/h	1021495
VS 50000 IP	50,000 l/h	1021496

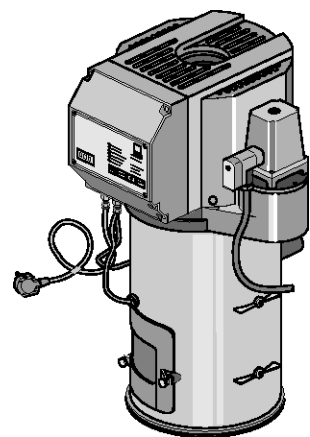

pk_3_032

Ultromat® powder conveyor FG 205

The Ultromat® powder feeder FG 205 is used to top up the dry feeder of the Ultromat® systems with commercially available powdered polymers. A suction hose and a suction lance are used to draw the powder from the storage container (Big Bag, powder storage tank) into the powder feeder and to transport it through a flap into the dry feeder of the polymer dissolving station. The powder feeder is self-controlled and simply needs a 230 V single-phase connection. External switch contacts are not needed. Approx. 40 kg powdered polymer can be transported per hour depending on the properties of the powder. The 4-metre long transport hose and extraction nozzle are included in the scope of delivery.

	Feed rate	Order no.
Powder conveyor FG 205 230 VAC/50 Hz	40 kg/h	1000664
Powder conveyor FG 205 230 VAC/60 Hz	40 kg/h	1061422

7 Polymer preparation and metering systems Ultromat®, PolyRex and POLYMORE

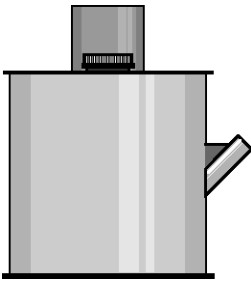

pk_7_033

Powder pre-storage tank

The powder pre-storage tank is used for interim storage of powdered polymers that are delivered in Big-Bags. The Big-Bag is suspended over the tank on a frame and emptied into the powder pre-storage tank.

	Order no.
Powder pre-storage tank	1005573

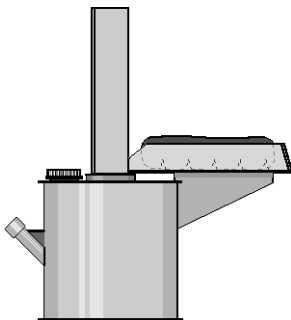

pk_7_060

Powder pre-storage tank with bag tipper

The powder pre-storage tank with bag tipper is used for interim storage of powdered polymers delivered in 25 kg sacks.

	Order no.
Powder pre-storage tank with bag tipper	1025137

7 Polymer preparation and metering systems Ultromat®, PolyRex and POLYMORE

Big-Bag emptying units

These emptying units are used to hold and empty Big Bags weighing up to 1,000 kg. A powder hopper is used to transfer the powder into a special feed unit, such as powder feeder FG 205, thereby ensuring the supply of powder to the dry feeder of the polymer preparation station.

Big Bag emptying unit, standard

- Height-adjustable frame
- Standard design in painted steel
- Integrated suspension cross for the Big Bags
- Suitable for loading with crane or fork-lift
- Powder storage tank with approx. 200-litre content
- Powder re-filling probe
- Vibration motor



P_UL_0036_SW

Order no.

Big Bag emptying unit, standard

1083075

Big Bag emptying unit with electrical lifting equipment

- Standard design in painted steel
- Integrated travelling crane
- Electrical lifting equipment with suspension cross for the Big Bags
- Powder storage tank with approx. 200-litre content
- Powder re-filling probe
- Vibration motor



P_UL_0035_SW

Order no.

Big Bag emptying unit with electrical lifting equipment

1083076

Big Bag emptying unit with dust-free emptying option

- Additional unit under the Big Bag including dust filter

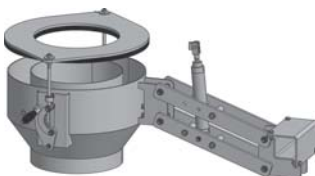

P_UL_0037_SW

Order no.

Big Bag emptying unit with dust-free emptying option

1083077

7 Polymer preparation and metering systems Ultromat®, PolyRex and POLYMORE

7.10

Preparation stations and metering of powdered and liquid polymer solutions PolyRex and POLYMORE

Preferred fields of application include:

- Potable water treatment
- Waste water treatment (industry and local authorities)
- Sludge de-watering
- Paper production

3 different automatic system concepts are available:

- Treatment system with vacuum conveyor (PolyRex)
- Treatment system with Big Bag emptying system (PolyRex Big Bag)
- Treatment system for commercially-available liquid polymer (PolyRex Liquid)

PolyRex is a turnkey system for treatment in batch quantities of powder and liquid polymers. All PolyRex systems rely on 2 stainless steel tanks; a batch maturing tank and a storage tank in a double-deck arrangement or in parallel.

PolyRex uses a highly effective, three-stage process for wetting, water acceleration and gentle but efficient mixing in the mixing tank, in order to produce a homogeneous, activated polymer solution.

The batch treatment system offers significant advantages over a continuous system. How?: The short circuit effect is avoided. They polymer particles cannot pass through the process without being activated.

The tried and tested multi-screw feeder ensures reliable drainage without pulsation along with precise metering. This ensures that batches are compiled precisely. When commercially-available liquid polymers are used, a reliable progressive cavity pump is used, ensuring safe and highly accurate metering.

PolyRex systems are fitted with a PLC compact controller and touchpanel. Optionally, the PLC compact controller can be fitted with PROFIBUS® or Ethernet module. Commissioning is made easy. Input of the solvent concentration, as well as calibration of the powder feeder and liquid concentrate pump is user-managed. Alarm messages and warnings are shown on the display.

7.10.1

Application example for a PolyRex polymer preparation system

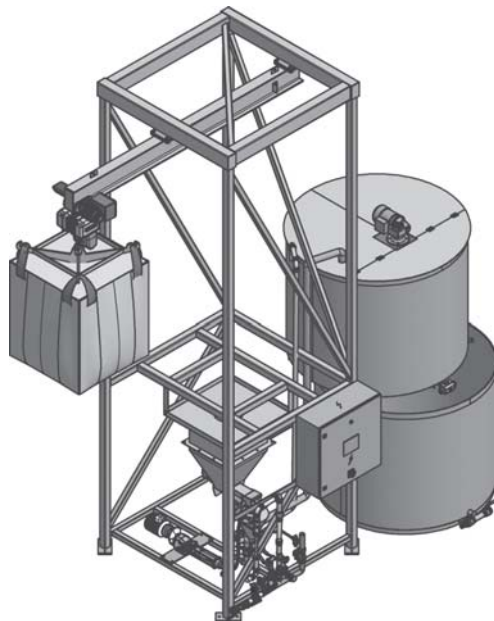

7 Polymer preparation and metering systems Ultromat®, PolyRex and POLYMORE

7.11 Metering system PolyRex



PolyRex can do more: Processes liquid and powdered polymers.

Capacity range of up to 8200 l/h

The metering system PolyRex is a double-decker batching station for the processing of liquid and powdered polymers. It consists of the feed and mixer unit and the two stainless steel double-decker tanks. The polymers used are ideally utilised.

The upper storage tank represents the batching/ maturing tank. The lower tank is the storage tank for the prepared polymer solution. The powdered polymer is transported to the powder feeder by a vacuum conveyor using 2 conveyor screws and mixed into 3 layers with water in the underlying mixer unit; wetting cone, water injector and stirrer in batching tank. The solution is then transferred to the upper storage tank using the water pressure of the diluting water. The polymer solution matures completely in this, a short circuit effect is avoided. After maturing, the solution can be transferred to the lower storage tank via the motorised valve.

Your benefits

Compact controller ABB AC500 PM573-ETH and touch panel CP635

- Dust-free filling of the powder storage tank thanks to use of a vacuum conveyor
- Double screw metering unit with 2 counter-rotating conveyor screws enables low-pulsation metering with a high level of dosing precision.
- Pressure reducer provides for a constant water supply
- Effective 3-phase mixing of the polymer solution
- No short-circuiting effect: polymer particles cannot pass through the process without activation

Technical Details

- Vacuum conveyor for filling from small powder bags
- Powder top hopper with inspection glass
- Powder level probe for detecting an empty top hopper
- Shut-off damper on feeder to prevent moisture infiltration
- Wetting cone in stainless steel for dissolving of the powder
- Water apparatus with wetting cone and injector to produce an effective and homogeneous polymer solution from powdered polymers
- Stainless steel tank for maturing and feeding the polymer solution in slightly offset double-deck arrangement for PolyRex 0.6 - 8.4, with adjacent tanks for PolyRex Maxi 11 - 23
- Motorised valve to dispense the solution into the storage tank
- Slow-running stirrer in the upper storage tank for gentle mixing of the polymer solution

Field of application

- Potable water treatment
- Waste water treatment (industry and local authorities)
- Sludge de-watering
- Paper production

Options

- Batching commercially-available liquid polymers using a progressive cavity pump
- Heating elements at wetting cone entrance and at feeder output (recommended for environment with high air humidity)
- PROFIBUS® or Ethernet communication
- Compact controllers from Siemens or Allen Bradley on request
- Water apparatus and piping in stainless steel design

Accessories

- Re-dilution with highly effective static mixer
- Progressive cavity pump with speed control
- Electromagnetic flow meter for precise control of the metering pump

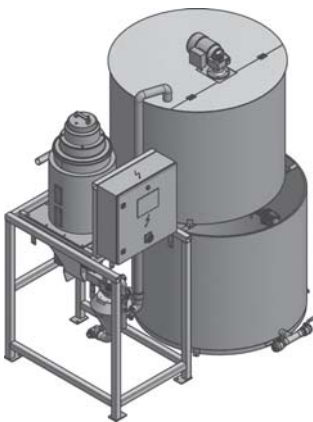

P_UL_0041_SW

NEW

7 Polymer preparation and metering systems Ultromat®, PolyRex and POLYMORE

	Tank volume	Discharge volume	Polymer dosing capacity
	m ³	l/h	kg/h
PolyRex 0.6	2 x 0.3	240	1.2
PolyRex 1.0	2 x 0.6	460	2.3
PolyRex 2.0	2 x 1.0	940	4.7
PolyRex 3.0	2 x 1.5	1,280	6.4
PolyRex 4.0	2 x 2.0	1,900	9.5
PolyRex 5.4	2 x 2.7	2,400	12.0
PolyRex 6.6	2 x 3.3	3,200	16.0
PolyRex 8.4	2 x 4.2	3,820	19.2
PolyRex Maxi 11	2 x 5.5	5,100	25.5
PolyRex Maxi 16	2 x 8.0	6,600	33.0
PolyRex Maxi 23	2 x 11.5	8,200	41.0

7 Polymer preparation and metering systems Ultromat®, PolyRex and POLYMORE

7.12 Metering system PolyRex Big Bag



The PolyRex can do more: it processes liquid and powdered polymers.

Capacity range of up to 8200 l/h

The metering system PolyRex is a double-decker batching station for the processing of liquid and powdered polymers. It consists of the feed and mixer unit and the two stainless steel double-decker tanks. The polymers used are ideally utilised.

The upper storage tank represents the batching/ maturing tank. The lower tank is the storage tank for the prepared polymer solution.

The powdered polymer is transported to the powder feeder by a vacuum conveyor using 2 conveyor screws and mixed into 3 layers with water in the underlying mixer unit; wetting cone, water injector and stirrer in batching tank. The solution is then transferred to the upper storage tank using the water pressure of the diluting water. The polymer solution matures completely in this, a short circuit effect is avoided. After maturing, the solution can be transferred to the lower storage tank via the motorised valve.

Your benefits

Compact controller ABB AC500 PM573-ETH and Touchpanel CP635

- Flexible and height-adjustable Big Bag emptying system with integrated spider clamp for loading with crane or forklift
- Double-screw feeder with 2 reverse conveyor screws enables low-pulsation metering with a high level of dosing precision
- Pressure reducer provides for a constant water supply
- Effective 3-phase mixing of polymer solution
- No short circuit effect, polymer particles cannot pass through the process without being activated

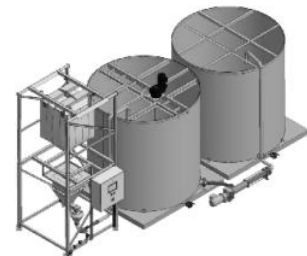

P_UL_0039_SW

Technical Details

- Powder top hopper with inspection glass
- Powder level probe for detecting an empty top hopper
- Shut-off damper on feeder to prevent moisture infiltration
- Wetting cone in stainless steel for dissolving of the powder
- Water apparatus with wetting cone and injector to produce an effective and homogeneous polymer solution from powdered polymers
- Stainless steel tank for maturing and feeding the polymer solution in slightly offset double-deck arrangement for PolyRex 0.6 - 8.4, with adjacent tanks for PolyRex Maxi 11 - 23
- Motorised valve to dispense the solution into the storage tank
- Slow-running stirrer in the upper storage tank for gentle mixing of the polymer solution

Field of application

- Potable water treatment
- Waste water treatment (industry and local authorities)
- Sludge de-watering
- Paper production

Options

- Big Bag emptying unit with travelling crane and electrical lifting equipment
- Dust-free emptying, thanks to additional unit under the Big Bag including dust filter
- Batching of commercially available liquid polymers by the use of an eccentric screw pump
- Heating element at the inlet of the wetting cone and/or at the outlet of the metering unit (recommended for environments with high air humidity)
- PROFIBUS® or Ethernet communication
- Compact Siemens or Allen Bradley controller on request
- Water apparatus and piping in stainless steel design

Accessories

- Re-dilution with highly effective static mixer
- Eccentric screw pump with speed control
- Electromagnetic flow meter for the precise control of the metering pump

NEW

7 Polymer preparation and metering systems Ultromat®, PolyRex and POLYMORE

	Tank volume	Discharge volume	Polymer dosing capacity
	m ³	l/h	kg/h
PolyRex 0.6	2 x 0.3	240	1.2
PolyRex 1.0	2 x 0.6	460	2.3
PolyRex 2.0	2 x 1.0	940	4.7
PolyRex 3.0	2 x 1.5	1,280	6.4
PolyRex 4.0	2 x 2.0	1,900	9.5
PolyRex 5.4	2 x 2.7	2,400	12.0
PolyRex 6.6	2 x 3.3	3,200	16.0
PolyRex 8.4	2 x 4.2	3,820	19.2
PolyRex Maxi 11	2 x 5.5	5,100	25.5
PolyRex Maxi 16	2 x 8.0	6,600	33.0
PolyRex Maxi 23	2 x 11.5	8,200	41.0

7 Polymer preparation and metering systems Ultromat®, PolyRex and POLYMORE

7.13 Metering system PolyRex Liquid

The PolyRex can do more: it processes common liquid polymers.

Capacity range of up to 3180 l/h



The metering system PolyRex is a double-decker batching station for the processing of liquid polymers. It consists of the feed and mixer unit and the two stainless steel double-decker tanks. The polymers used are ideally utilised.

The upper storage tank represents the batching/maturing tank. The lower tank is the storage tank for the prepared polymer solution.

The liquid polymer is fed in by an eccentric screw pump and an injection nozzle and mixed with water in 2 stages by means of a water injector and a stirrer in the batching/maturing tank. The solution is transferred to the upper storage tank using the water pressure of the diluting water. The polymer solution can fully mature in this, avoiding a short-circuiting effect. After maturing, the solution can be transferred to the bottom storage tank via the motorised valve.

Your benefits

Compact controller ABB AC500 PM573-ETH and touch panel CP635

- Reliable eccentric screw pump for the metering of commercially available polymers
- High energy mixing process
- Unique injection nozzle prevents clogging of the liquid polymer
- Pressure reducer provides for a constant water supply
- Effective 2-phase mixing of the polymer solution
- No short-circuiting effect: polymer particles cannot pass through the process without activation

Technical Details

- Water apparatus with wetting cone and injector to produce an effective and homogeneous polymer solution
- Double-decker storage tank made of stainless steel for maturing and storing the polymer solution
- Motorised valve to dispense the solution into the storage tank
- Slow-rotating stirrer in the upper storage tank for the gentle mixing of the polymer solution

Field of application

- Waste water treatment (industry and local authorities)
- Sludge de-watering

Options

- PROFIBUS® or Ethernet communication
- Compact controllers from Siemens or Allen Bradley on request
- Water apparatus and piping in stainless steel design

Accessories

- Re-dilution with highly effective static mixer
- Eccentric screw pump with speed control
- Electromagnetic flow meter for precise control of the metering pump

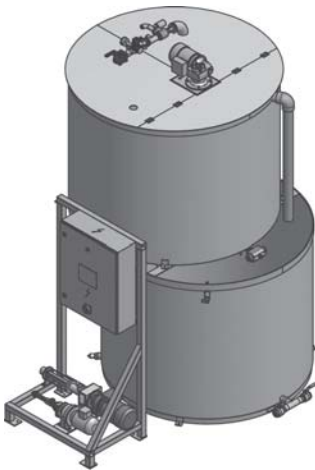

P_UL_0038_SW

NEW

	Tank volume	Discharge volume	Polymer dosing capacity
	m ³	l/h	kg/h
PolyRex Liquid 1.0	2 x 0.5	1,060	5.3
PolyRex Liquid 2.0	2 x 1.0	1,900	9.5
PolyRex Liquid 3.0	2 x 1.5	2,480	12.4
PolyRex Liquid 4.0	2 x 2.0	3,180	15.9

Note:The capacity of liquid polymer in kg/h denotes a 100 % active ingredient content. Naturally, the concentration of the active ingredient in the systems can be adjusted to the commercially available liquid polymers with a 30 - 60 % active ingredient percentage.

7 Polymer preparation and metering systems Ultromat®, PolyRex and POLYMORE

7.14 Metering System POLYMORE

The POLYMORE in-line batching station creates homogeneous and ready-to-use polymer solutions.

Capacity range of up to 18,000 l/h



The metering system POLYMORE is the inline preparation station in which the liquid polymer is introduced into the pressure-encapsulated multi-zone mixing equipment through a peristaltic pump. The result is a prepared and homogeneous polymer solution.

The POLYMORE metering system is an inline polymer preparation system for processing liquid polymers. The unit was designed for wall-mounting and requires little space. Only water, liquid polymer and supply voltage need to be connected to the unit for commissioning. If the maturing time is not sufficient for certain applications, a maturing tank with stirrer and metering pump can be fitted downstream.

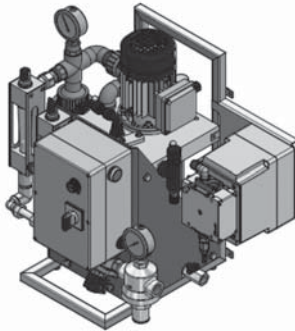

P_UL_0017_SW

Your benefits

- Wall-mounted: saves space
- Low-maintenance peristaltic pump for metering the liquid polymer
- Simple and fast to connect: requires only water, liquid polymer and power
- Automatic control

Technical Details

- Peristaltic pump for metering liquid polymer
- Water apparatus includes pressure reducer and solenoid valve
- Pressure-encapsulated mixing system for the effective production of polymer solution
- Re-dilution unit with static mixer and manometer
- Controller for the automated control of the device. Manual or 4-20 mA control of the peristaltic pump

Field of application

- Waste water treatment (industry and local authorities)
- Sludge de-watering

Options

- High-pressure design (for back pressures of over 1 bar)
- Metering pump control
- Flow control (metering pump)
- Heating to avoid condensation
- Electrically operated ball valve in place of the solenoid valve for the input water

Accessories

- Maturing tank with or without stirrer
- Maturing tank with or without metering pump
- Collecting pan
- Level control (maturing tank)

	Diluent water max. l/h	Liquid polymer dosing capacity l/h	Order no.
POLYMORE mini 2-0.08	120	0.08	1029568
POLYMORE mini 2 – 0,2	120	0.20	1083627
POLYMORE mini 3-0.6	180	0.60	1029570
POLYMORE mini 5-0.6	300	0.60	1029571
POLYMORE mini 5-1.2	300	1.20	1029572
POLYMORE mini 10-1.2	600	1.20	1029574
POLYMORE mini 10-2.4	600	2.40	1029575
POLYMORE mini 30-3.0	1,800	3.00	1029576
POLYMORE duo 40-6.0	2,400	4.00	1029577
POLYMORE duo 65-9.0	3,900	8.00	1029579
POLYMORE midi 100-12	6,000	12.00	1029580
POLYMORE midi 160-24	9,600	20.00	1029581
POLYMORE midi 175 – 38	10,500	38.00	1083628
POLYMORE maxi 300-54	18,000	50.00	1029584

7 Polymer preparation and metering systems Ultromat®, PolyRex and POLYMORE

7.15

PolyRex accessories – mixing systems

The PolyRex and PolyRex Big Bag systems are fitted with special mixing systems for powdered polymer.

Efficient mixing systems for polymers

	PolyRex Classic	Use Standard	Polymer ■ Powder ■ Liquid	Mixing unit Cyclonic wetting cone	Application / benefits ■ Reliable and effective hydration
PolyRex-Classic					
	PolyRex Optimo	Use Optional	Polymer ■ Powder ■ Liquid	Mixing unit Closed system with heated wetting area and integrated mixing pump	Application / benefits ■ Highly efficient polymer mixing ■ Reliable and dust-free ■ Very low powder consumption
PolyRex-Optimo					
	PolyRex Aero Mix	Use Optional	Polymer ■ Powder	Mixing unit Closed system with pneumatic powder conveyance, fans, water nozzles, mixing tank	Application / benefits ■ High air humidity ■ High ambient temperature
PolyRex-Aero-Mix					

8 Membrane Technology and Membrane Filtration

8.1 Overview of Membrane Technology

Systems for membrane filtration

In water treatment, membrane filtration is the process for removing particles and salts in the water ensuring the lowest operating costs. ProMinent offers versatile and high-quality system technology in this field. This is complemented by the extensive ProMinent product range to produce customer-specific complete solutions.

Membrane filtration is a physical process to separate substances with the help of semi-permeable membranes. There are four types of processes, depending on the size of the particles/molecules to be removed:

- Microfiltration
- Ultrafiltration
- Nanofiltration
- Reverse osmosis

The following table shows the separation limits of the individual processes:

	Microfiltration	Ultrafiltration	Nanofiltration	Reverse osmosis
Particle size	> 0.1 µm	0.1 – 0.01 µm	0.01 – 0.001 µm	< 0.001 µm
Particle type	Suspended particles, colloidal turbidity, oil emulsions	Macromolecules, bacteria, cells, viruses, proteins	Low-molecular organic compounds, ions	Ions

ProMinent experts, with their detailed industry knowledge, are not only able to put together the optimum system for the relevant application but also deliver complete water treatment solutions from one source, supported by the extensive ProMinent product range.

8 Membrane Technology and Membrane Filtration

8.2 Performance Overview of Ultrafiltration

Ultrafiltration is a membrane process which is increasingly used in water treatment to separate undesired water components. Parasites, bacteria, viruses and high-molecular organic substances as well as other particles are retained.

The applications of ultrafiltration are widespread and may include different types of water.

Typical applications include drinking water, river water, process water, swimming pool water, salt water and waste water.

The tasks range from potable water purification to meet physical and microbiological limit values in accordance with the German Drinking Water Ordinance up to the pre-treatment of seawater for desalination by reverse osmosis.

The systems are matched to a specific task by individually selecting the membrane type and the operating mode. ProMinent uses extremely robust and resistant UF membranes and the dead-end principle to ensure optimisation with regard to investment costs, required space and operating costs. With this selection, all raw waters with the exception of waste water can be filtered largely without using chemicals.

The dead-end operation represents the standard operating mode. The raw water flows into the capillaries. The pure water (filtrate) passes through the membrane while the other constituents are retained on the surface of the membrane.

The constituents form a layer on the membrane. The membrane is backwashed fully automatically in regular intervals to remove the filter cake.

Ultrafiltration systems basically consist of:

- Stainless steel or high-grade coated steel rack
- Pre-filter to protect the membranes, if required. This filter can optionally be designed as a backwashing filter.
- UF membrane modules
- Pneumatically controlled valves made of high-quality materials
- Electronic pressure measurement
- Filtration pump and backwash pump with frequency converter made of suitable high-quality materials
- Magnetically inductive flow metering to control the flow rates for filtration and backwashing.
- Integrated filling system for the backwash water tank. The backwash water tank is also integral to small systems. With larger systems, tanks from our product range can be integrated or an application-specific solution found depending on the customer's requirements.
- PLC control with touch screen panel or microprocessor control unit.
The PLC control simultaneously monitors all important parameters, such as pressure, pressure difference and flow rates. This ensures that the membranes are optimally protected. The control of pre- and post-treatment processes can be integrated, if required.

Advantages of ultrafiltration systems

- Filtrate values of less than 0.1 NTU independent of the turbidity of the raw water.
- Molecular weight cut off of the membranes (MWCO) approx. 100 kDa (kilodalton).
- Best possible retention rates for bacteria (99.9999%) and viruses (99.99% based on MS2 phages).
- Very easy to use and simple to combine with other systems owing to PLC Programmable Logic Controller with touch screen.
- Optimum operating processes due to modern measuring and control technology.
- Complete solutions with perfectly coordinated pre- and post-treatment are available on request.

8 Membrane Technology and Membrane Filtration

Areas of application of ultrafiltration systems

Typical areas of application include the removal of particles, turbidity and pathogens in public or private potable water supplies. Ultrafiltration is predominantly used for the treatment of fresh water, in particular surface water, spring water or well water. In principle, brackish water and salt water can also be treated, e.g. as pre-treatment for subsequent desalination by nanofiltration or reverse osmosis. Further areas of application include the treatment of swimming pool water, process water from the food and beverage industry.

A typical general system layout is shown below:

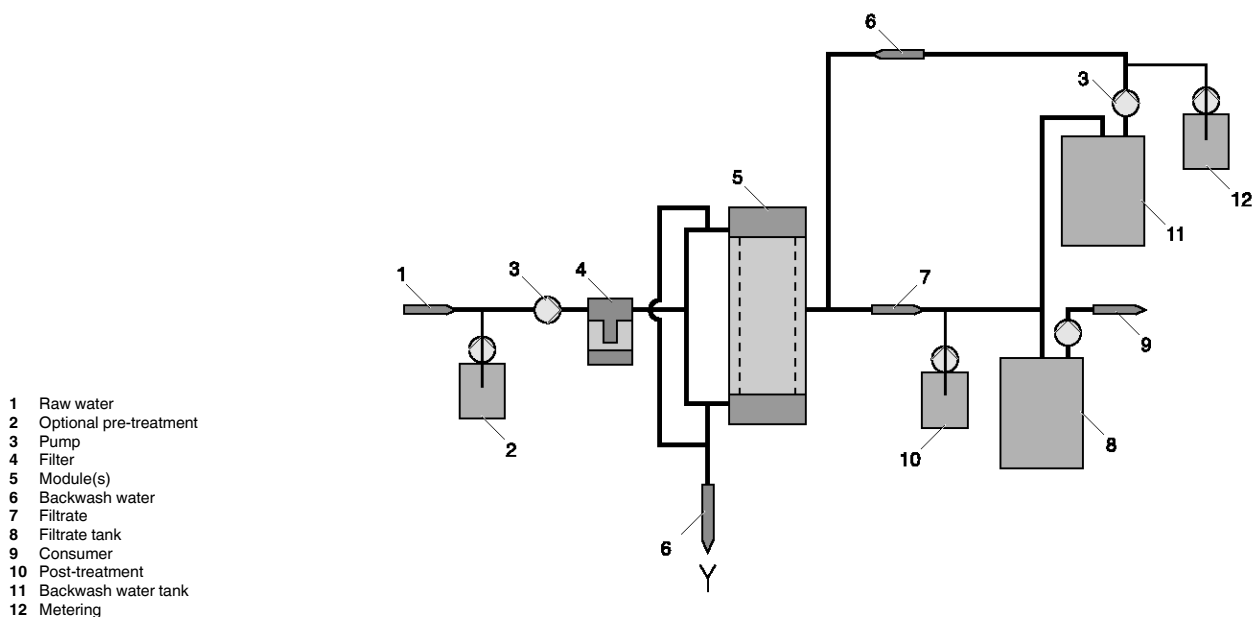

P_PMA_UO_0008_SW

Our engineers use their wide experience in water treatment to determine the ultrafiltration system to meet the specific raw water requirements. If desired and/or required, the best-suited pre- and post-treatment is also defined. Numerous further ProMinent® products are available for this purpose. Thus, customers are offered a complete package of solutions from one single source.

The filtration capacity of ultrafiltration systems ranges from 1 to 80 m³/h. Other capacities are available on request. Please contact us, we will be glad to assist you.

8 Membrane Technology and Membrane Filtration

8.3

Nanofiltration System Dulcosmose® NF

Partial desalination for industrial applications - compact and cost-effective

Permeate outputs from 1 to 50 m³/h, higher outputs possible on request



As a nanofiltration system, the Dulcosmose® NF, a compact and value-for-money unit, can take over partial desalination in industrial applications. Maximum permeate output at low operating pressures ensures low investment and operating costs thanks to the latest "ultra low pressure" membrane.

Equipped with the latest generation of "ultra low-pressure" membranes, this system achieves maximum permeate performance with low operating pressures and high outputs, thereby lowering investment and operating costs.

As the system runs with low operating pressures, the entire system can be fitted with inexpensive PVC pipework. This system is also available with an integral, semi-automated cleaning system and permeate and/or raw water flushing option.

The system can easily be adapted to meet specific customer requirements. Pipework material, other types of membrane for enhanced salt retention or discoloration, integration of measuring and control technology (such as conductivity, redox potential or pH measurement) and metering technology (in pre- and post-treatment) to visualisation of the entire process with peripheral components on a PLC.

Your benefits

- Efficient operation with a low pressure membrane with outputs of up to 85% and high salt retention rates of up to 90% (depending on the type of membrane used).
- Reduced maintenance and service costs, as well as long membrane service lives, thanks to integrated cleaning concepts and flushing options.
- Optional permeate flushing of the entire system, including the membranes, after switching off to avoid deposits and extend the life of the membranes.
- Best ProMinent manufacturing quality: High proportion of in-house manufacturing.
- Pure quality: Use of long-life, high-quality components.
- Service-friendly construction of systems on a corrosion-resistant powder-coated steel or stainless steel frame.
- Simple and safe to operate: Microprocessor control with direct connection option for peripheral system components and integrated conductivity measurement with plain text display in the graphic display.
- One-stop shop: no interface problems, smooth running with short times between definition of the task to joint commissioning and on-site system supervision with our global subsidiaries.

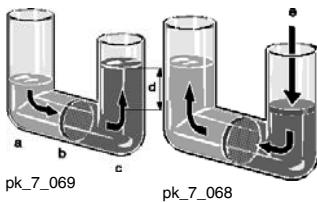

pk_7_069
pk_7_068

a Diluted solution (permeate)
b Semi-permeable membrane
c Concentrated solution (concentrate)
d Hydrostatic head corresponding to the osmotic product
e Pressure

Osmosis Nanofiltration

Technical Details

- Turnkey systems constructed on a high-quality, double powder-coated steel or stainless steel frame.
- Highly efficient low-pressure membranes with maximum output and system retention rates, built into epoxy-glass resin or stainless steel pressure pipes
- Pre-filter 5 µm with manometer for determining differential pressure
- Pressure switch to protect the high-pressure pump
- Flow meter to display permeate, concentrate and concentrate return volume
- Semi-automatic cleaning system for chemical module cleaning for long module service lives
- Central control for the entire system and peripheral components by the company's own microprocessor controller with graphic display and integrated temperature-compensated conductivity measurement.
- Optional permeate flushing of the entire system, including the membranes, after switching off
 - 2 switching inputs for level control of the cleaning tank
 - 2 switching inputs for level control of the permeate tank
 - Pause switching input for external On/Off
 - External fault switching input
 - Temperature measuring input (Pt 100)
 - Active permeate valve output (filling of cleaning tank)
 - Active output for flushing valve for initial permeate disposal (depending on conductivity), raw water, permeate and interval flushing (idle time management)
 - Active output for controlling a metering pump (anti-scalant)
 - Analogue output 0/4...20 mA conductance
- Optional industrial PLC with touch panel and process visualisation

8 Membrane Technology and Membrane Filtration

Field of application

- Low-cost alternative to reverse osmosis systems for special desalination tasks, such as the elimination of multiple charged ions or the removal of dyes
- Partial water softening or water softening in public drinking water
- Partial desalination in the chemical and pharmaceutical industry, food and beverage industry, metal processing industry and in electroplating

Nanofiltration is based on the same principle as reverse osmosis. The difference: The separation limit is slightly lower. Admittedly this type of membrane filtration retains ions dissolved in water, but to a significantly lesser extent than with reverse osmosis. Ultimately that saves operating costs.

Typical salt retention rates are around 80 – 90%. Multi-value ions (e. g. Ca and Mg) are retained better than single-value ions (e. g. Na, K) so that nanofiltration systems are often also used as an alternative to traditional water softening.

In principle with nanofiltration, the raw water to be softened is introduced into a chamber, separated by a semi-permeable membrane. An artificial pressure is generated in the chamber against the osmotic pressure gradient. The membrane is permeable to pure water and smaller ions. All other components of the water are retained. This produces partially softened water (permeate) and a concentrated solution (concentrate). ProMinent uses high-quality nanofiltration membranes for this process.

8 Membrane Technology and Membrane Filtration

8.4 Performance Overview of Reverse Osmosis

Reverse osmosis is a sub-sector within membrane filtration. It is the process with the highest separation limit and represents the reversal of the natural process of osmosis. It is therefore used as a method for desalinating aqueous solutions. With suitable high-performance membranes, it is possible today to remove over 99% of all salts from an aqueous solution.

In principle with reverse osmosis, the raw water to be softened is introduced into a chamber, separated by a semi-permeable membrane. An artificial pressure is generated in the chamber against the osmotic pressure gradient. As the membrane is only permeable to pure water, not to the ions and other particles dissolved in it, a proportion of pure desalinated water (permeate) and a proportion of concentrated solution (concentrate) is produced from the raw water. ProMinent uses high-quality low-pressure membranes for this process.

Basically, Dulcosmose® Reverse Osmosis Systems Consist of:

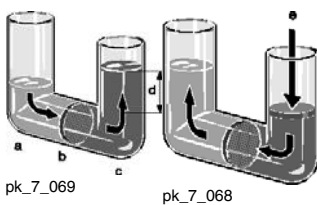

pk_7_069
pk_7_068

a Diluted solution (permeate)
b Semi-permeable membrane
c Concentrated solution (concentrate)
d Hydrostatic head corresponding to the osmotic product
e Pressure

Osmosis Reverse Osmosis

- Stainless steel, PP or powder-coated steel frame
- Pre-filter 5 µm
- High-quality inlet valve, made of appropriate materials, depending on the salt content of the raw water
- Pressure switch to protect the high-pressure pump
- High-pressure pump, made of suitable high-grade materials, depending on the salt content of the raw water
- Low-pressure membranes, designed as spiral winding modules, integrated into epoxy-glass resin pressure pipes
- Float flow meter and manometer
- Stainless steel control and regulating valves to regulate pressure and concentrate
- ProMinent's own conductivity measuring cell and reverse osmosis control with diverse programming options also for controlling external pre- or post-treatment components
- Semi-automatic chemical cleaning system

Advantages of Dulcosmose® Reverse Osmosis Systems

- Simple and reliable operation, thanks to modern microprocessor control with integrated conductivity measurement and clear text display of the operating status
- Efficient operation with pure water output of up to 85% and separation of more than 99% of dissolved ions
- Minimal energy consumption by the use of "low energy" reverse osmosis membranes and energy recovery from the concentrate flow (salt water desalination)
- Long service lives of the membranes, thanks to integrated cleaning concept and permeate and/or raw water flushing option
- Well thought-out, service-friendly construction of the systems on stainless steel or PP frames or made of powder-coated steel
- Minimal investment and operating costs, as components are used, optimised and matched to the individual case
- On request, complete solutions with precisely coordinated pre- and post-treatment, such as ProMinent metering and measuring and control technology, i.e. simple networking, perfect operation and overall monitoring of the different components of the system

8 Membrane Technology and Membrane Filtration

Applications of Dulcosmose® Reverse Osmosis Systems

Typical applications are desalination duties in municipal or private potable water supply, in the chemical and pharmaceutical industries, food and beverage industry, metal processing industry, electroplating, in boiler feed water treatment and in power stations, for example.

A typical general plant diagram is shown below:

- 1 Raw water
- 2 Filter
- 3 Pump
- 4 Module(s)
- 5 Concentrate
- 6 Permeate
- 7 Permeate tank
- 8 User
- A Pre-treatment
- B Reverse osmosis
- C Post-treatment

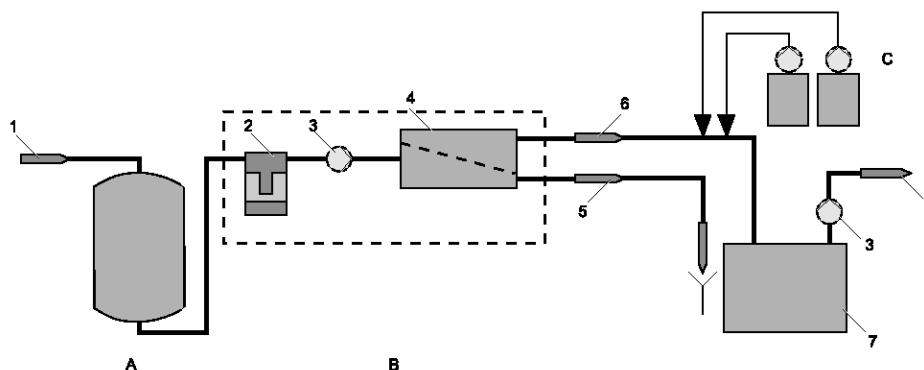

pk_7_067

Basically, three types of raw water with different salt contents can be considered for desalination:

- Potable water (typically up to 1,000 mg/l)
- Brackish water (typically up to 2,000 - 5,000 mg/l)
- Sea water (typically higher than 35,000 mg/l)

Our engineers use their years of experience in the treatment of this raw water to determine - based on the particular raw water analysis - the optimum version of reverse osmosis plant for the customer. At the same time, the most suitable pre-treatment and post-treatment stages are selected using other ProMinent® products. So a complete package is put together for the customer, from a single source. One of our specialities here is the supply of complete plants installed in a standard transport container.

Type	ecoPRO	TW	BW	SW
Permeat-output [m³/h]	50			
	25			
	10			
	5			
	2,5			
	1			
	0,5			
	0,25			
	0,1			
Salinity Drinking water	< 1.000 mg/l	< 1.000 mg/l	< 5.000 mg/l	< 40.000 mg/l

P_PMA_MT_0002_SW

8 Membrane Technology and Membrane Filtration

8.5 Questionnaire

8.5.1 Questionnaire on the Design of a UF System

Application:

Drinking water production

Process water for food/beverage industry

Circulation water for swimming pools

Flushing water for swimming pools

Other: _____

Type of raw water

Drinking water

Surface water (lake, river water)

Source water

Ground water

Brackish water, sea water

Design principles: (please state maximum (peak), minimum and average values)

Clear water requirement: _____ m ³ /h	Chloride: _____ ppm
Clear water requirement: _____ m ³ /day	Iron in solution: _____ ppm
Temperature: _____ °C	Particular iron: _____ ppm
Turbidity: _____ NTU	Manganese In solution: _____ ppm
COD: _____ ppm	Particular manganese: _____ ppm
TOC/DOC: _____ ppm	Fluctuations? Yes <input type="checkbox"/> No <input type="checkbox"/>
Total hardness: _____ °dH	

Remarks (current pre-treatment, special requirements)

P_PMA_MT_0001_SW

8 Membrane Technology and Membrane Filtration

8.5.2 Questionnaire on the Design of an RO System

Clean water requirement: _____ m ³ /h	Available space HxWxD: _____ m
Clean water requirement: _____ m ³ /day	Location of the system: _____ Floor
Operating hours: _____ h/day	Location of the users: _____ Floor
Required clean water pressure: _____ bar	Existing clean water tank: _____ m ³
Raw water temperature, min./max.: _____ °C	Existing clean water pump: _____ m ³ /h _____ bar
Required quality of clean water:	Lift yes <input type="checkbox"/> no <input type="checkbox"/>
Conductivity: _____ µS/cm	H x W x D: _____ mm
pH value: _____	Door dimensions
Bacteriological quality:	H x W _____ mm
Drinking Water Directive <input type="checkbox"/>	Crane on site: yes <input type="checkbox"/> no <input type="checkbox"/>
Germ-free and sterile <input type="checkbox"/>	Lifting capacity: _____ t
Intended use of clean water: _____	Raw water pressure: _____ bar
Type of raw water:	Raw water connection: _____ "
Drinking water <input type="checkbox"/>	Clean water pipes available yes <input type="checkbox"/> no <input type="checkbox"/>
Well water <input type="checkbox"/>	Material: _____ Ø _____ "
Brackish water <input type="checkbox"/>	Mains voltage: _____ V/Hz
Lake water <input type="checkbox"/>	
or _____ <input type="checkbox"/>	
Fluctuations: yes <input type="checkbox"/> no <input type="checkbox"/>	
State fluctuations:	
Conductivity: _____ µS/cm	HCO ₃ : _____ mg/l
pH value: _____	SO ₄ : _____ mg/l
Ca: _____ mg/l	Cl: _____ mg/l
Mg: _____ mg/l	NO ₃ : _____ mg/l
K: _____ mg/l	F: _____ mg/l
Na: _____ mg/l	PO ₄ : _____ mg/l
Ba: _____ mg/l	CO ₂ (free): _____ mg/l
Sr: _____ mg/l	SiO ₂ : _____ mg/l
Fe: _____ mg/l	COD*: _____ mg/l
Mn: _____ mg/l	
Al: _____ mg/l	

*COD = chemical oxygen demand

8 Membrane Technology and Membrane Filtration

8.6 Ultrafiltration System Dulcoclean® UF

8.6.1 Ultrafiltration Systems Dulcoclean® UF

Pure, crystal-clear potable water at all times

8 – 75 m³/h filtrate output



Ultrafiltration system Dulcoclean® UF reliably and safely uses membrane technology to remove turbidity, particles and microbiological contamination.

The ultrafiltration system Dulcoclean® UF is used in water treatment to separate the finest particles and turbidity. The membranes provides a sterile barrier, so that bacteria, parasites and viruses are safely removed from the water – even with fluctuating water quality, as can occur after heavy rainfall. The quality of the filtrate remains consistently good! In potable water treatment, the filtration process is ideally used before final disinfection.

In regular cycles, back washes are performed to prevent blockages in the modules. Cleaning is supported by the addition of chemicals, where necessary, and adapted to the raw water quality present.

Your benefits

- Very high retention rates for bacteria and viruses (based on MS2 phages) of 99.999% and/or 99.99%
- Minimal consumption of energy and water by economical dead-end operation
- Maximum operational reliability due to fully automated system control with PLC and data storage and by user-friendly touch panel with clear process visualisation
- All relevant events are recorded electronically for system optimisation and can be easily evaluated.
- Constant filtrate output and efficient back flushing by speed-controlled filtration and backwash pumps
- Complete solutions with perfectly coordinated pre- and post-treatment and waste water treatment

Technical Details

- Compact design can be installed in existing plant rooms or in a container
- Fitted with extremely resistant and shatter-proof PES ultrafiltration membranes

Field of application

- Municipal potable water treatment: Potable water is produced from surface, spring or well water.
- Food and beverage industry: Improved water quality.
- Desalination: Pre-treatment for downstream desalination plants (RO, NF or ion exchange)

Dulcoclean® ultrafiltration systems are suitable for use with the following water values in the feed:

pH range	3.0 ... 12.0
Free chlorine	< 1.2 mg/l
Turbidity	0.5 ... 30 NTU
DOC	0.5 ... 12 mg/l
Suspended solids	50 mg/l

Deviating values influence the performance data and require a separate design of the system. Please contact our experts.

Dulcoclean® type	Filtration capacity* at 15 °C m ³ /h	Approx. backwash water per rinse m ³	Raw/rinsing water connector [Rp/DN]	Approx. dimensions LxWxH [mm]
UF 2	8 - 15	0.34	1 1/2 "/2 "	1,200 x 920 x 2,100
UF 3	12 - 22.5	0.51	2 "/DN 65	1,600 x 920 x 2,100
UF 4	16 - 30	0.68	2 "/DN 80	1,600 x 920 x 2,100
UF 6	24 - 45	1.02	DN 65/DN 80	2,000 x 920 x 2,100
UF 8	32 - 60	1.36	DN 80/DN 100	2,400 x 920 x 2,100
UF 10	40 - 75	1.70	DN 100/DN 125	2,800 x 920 x 2,100

* Filtrate performance depends on the water quality

Systems with filtration capacity of more than 18 m³/h are designed on a project basis. Offers are available on request. Please contact us.

Optionally available are a fully automatic neutralisation system for the treatment of acid and alkaline backwash water, an integrity test as well as customised data logging.

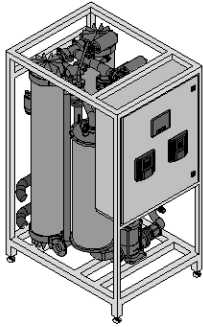

P_PMA_MT_0003_SW

8 Membrane Technology and Membrane Filtration

8.7

Reverse Osmosis System Dulcosmose®

8.7.1

Reverse Osmosis System Dulcosmose® ecoPRO

Potable water desalination for industrial applications - compact and cost-effective

Permeate output 100 – 2,700 l/h

Reverse osmosis system Dulcosmose® ecoPro ensures low investment and operating costs with maximum permeate output at low operating pressures.

As the system runs with low operating pressures, the entire system can be fitted with inexpensive PVC pipework and/or with pressure hoses. The system sizes ecoPRO 600-2,700 are also available with integrated semi-automatic cleaning system and raw water flushing option. The cleaning system can also be simply retrofitted. Equipped with the latest generation of "ultra low-pressure" membranes, this system achieves maximum permeate performance with low operating pressures, thereby lowering investment and operating costs.

Your benefits

- Efficient operation with low pressure membranes with outputs of up to 85% and salt retention rates of up to 97%
- Reduced maintenance and service costs as well as long membrane service lives, thanks to integrated cleaning concepts and flushing options
- Service-friendly construction of systems on a corrosion-resistant powder-coated steel or PP frame
- Simple and safe to operate: Microprocessor control with direct connection option for peripheral system components and integrated conductivity measurement with plain text display in the graphic display
- One-stop integration into customised complete solutions by perfectly coordinated pre- and post-treatment from ProMinent.

Technical Details

- Types ecoPRO 100 – 1,500 are mounted on an extremely stable and corrosion-free PP frame.
- Larger types ecoPRO 1,800 – 2,700 are mounted on a high-quality, double powder-coated steel frame.
- Highly efficient operation with outputs of up to 85% and system retention rates of up to 97% integrated in epoxy-glass resin pressure pipes
- Pre-filter 5µm with manometer for determining differential pressure
- Pressure switch to protect the high-pressure pump
- Flow meter to display permeate and concentrate volume
- Optional semi-automatic cleaning system for chemical module cleaning for long module service lives
- 2 switching inputs for level control of the cleaning tank
- 2 switching inputs for level control of the permeate tank
- Pause switching input for external On/Off
- External fault switching input
- Temperature measuring input (Pt 100)
- Active permeate valve output (filling of cleaning tank)
- Active output for flushing valve for initial permeate disposal (depending on conductivity), raw water, permeate and interval flushing (idle time management)
- Active output for controlling a metering pump (anti-scalant)
- Analogue output 0/4 - 20 mA conductance

Field of application

- Power plants: Provision of boiler feed water
- Electroplating / metal processing industry: Provision of rinsing water
- Beverage industry: Provision of rinsing water, product water and process and return dilution water
- Food industry: Provision of rinsing water and process water
- Chemical industry: Provision of rinsing water and process water
- Provision of rinsing water and process water for laboratory purposes and industrial rinsing machines
- Pure water for laboratory applications, hospital uses (autoclaves, high-speed steam generators)
- Feed water for cooling and air conditioning plants (air humidification and air scrubbers)
- Process water in printing plants, the pharmaceutical or cosmetics industry
- Car-washing systems: Provision of rinsing water

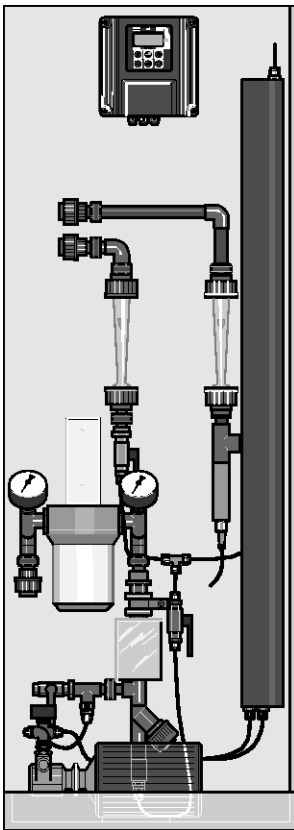

pk_7_062_V2

8 Membrane Technology and Membrane Filtration

Dulcosmose® ecoPRO reverse osmosis systems on PP rack; capacity range 100-1,500 l/h

This range is the cost-effective standard system for modern potable water desalination. Equipped with the latest generation of "ultra low-pressure" membranes, these systems achieve maximum permeate capacity at low operating pressures, thereby ensuring reduced investment and running costs. The low operating pressures enable the systems to be fitted cost-effectively with PVC pipes or pipes with pressure hoses throughout.

The ecoPRO 600-1500 models are additionally available with an integrated semi-automatic cleaning system and raw water flushing option. The semi-automatic cleaning system can also be simply retrofitted.

The ecoPRO 100-1500 range was designed for the following values in feed water:

Max. salt content ecoPro 100-500	650 mg/l*
Max. salt content ecoPro 600-1,500	1,000 mg/l*
pH range	3.0 ... 10.0
Silt density index max.	3
Free chlorine max.	0.1 mg/l
Total Fe, Mn max.	0.2 mg/l
Total hardness max.	0.1 °dH
Bacteria count max.	100 KBE/ml
Turbidity max.	0.5 NTU
COD max.	5 mg/l**

* Differing salinities affect the performance data accordingly

** As O₂

Systems with 2.5 or 4" membranes, system salt retention 90-97%

Plant	Permeate capacity at 15 °C water temperature l/h	Number of 2.5" and 4" membranes No.	Connected load kW	Dimensions H x W x D		Weight kg
				mm		
ecoPRO 100	100	1	0.37	1,400 x 500 x 320		47
ecoPRO 200	200	2	0.55	1,400 x 500 x 320		63
ecoPRO 300	300	1	1.10	1,500 x 600 x 400		88
ecoPRO 550	550	2	1.10	1,500 x 600 x 400		112
ecoPRO 600	600	2	1.50	1,650 x 700 x 720		167
ecoPRO 900	900	3	1.50	1,650 x 700 x 720		192
ecoPRO 1200	1,200	4	1.50	1,650 x 700 x 720		217
ecoPRO 1500	1,500	5	2.20	1,650 x 700 x 720		243

8 Membrane Technology and Membrane Filtration

Dulcosmose® ecoPRO reverse osmosis systems on powder-coated steel rack; capacity range 1,800-2,700 l/h

This range is the standard model for modern potable water desalination. Equipped with the latest generation of "ultra-low-pressure" membranes, these systems guarantee maximum permeate output at low operating pressures and thus low investment and operating costs. The low operating pressures enable cost-effective PVC pipes to be used. These systems are also available with an integrated semi-automatic cleaning system and with raw water flushing option.

The ecoPRO 1800-2700 range was designed for the following values in feed water:

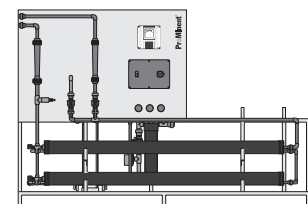

P_PMA_UO_0021_SW

Salt content max.	1,000 mg/l*
pH range	3.0 ... 10.0
Silt density index max.	3
Free chlorine max.	0.1 mg/l
Total Fe, Mn max.	0.2 mg/l
Total hardness max.	0.1 °dH
Bacteria count max.	100 KBE/ml
Turbidity max.	0.5 NTU
COD max.	5 mg/l**

* Differing salinities affect the performance data accordingly

** As O₂

Systems with 4" membranes, system salt retention 90-97%

Plant	Permeate capacity at 15 °C water temperature l/h	Number of 4" membranes No.	Connected load kW	Dimensions		Weight kg
				H x W x D mm		
ecoPRO 1800	1,800	6	2.2	1,750 x 2,600 x 750		260
ecoPRO 2400	2,400	8	3.0	1,750 x 2,600 x 750		299
ecoPRO 2700	2,700	9	3.0	1,750 x 3,500 x 750		315

8 Membrane Technology and Membrane Filtration

8.7.2

Reverse Osmosis System Dulcosmose® TW

Potable water desalination for industrial applications - compact and cost-effective

Permeate output 3 – 50 m³/h



Reverse osmosis system Dulcosmose® TW is the all-purpose model for modern potable water desalination. Maximum permeate output at low operating pressures ensures low investment and operating costs.

As the system runs with low operating pressures, the entire Dulcosmose® TW can be fitted with inexpensive PVC pipework. This system is also available with an integral, semi-automated cleaning system and permeate and/or raw water flushing option. Equipped with the latest generation of "ultra low-pressure" membranes, this system achieves maximum permeate output with low operating pressures, thereby lowering investment and operating costs.

The system is very adaptable to specific customer requirements. Pipework material, other types of membrane for enhanced salt retention, integration of measuring and control technology and metering technology to visualisation of the entire process with peripheral components via a PLC.

Your benefits

- Efficient operation with low pressure membranes with outputs of up to 85% and high salt retention rates of up to more than 99% (depending on the type of membrane used)
- Reduced maintenance and service costs as well as long membrane service lives thanks to integrated cleaning concepts and flushing options, such as permeate flushing
- Service-friendly construction of systems on a corrosion-resistant powder-coated steel or stainless steel frame
- Simple and safe to operate: Microprocessor control with direct connection option for peripheral system components and integrated conductivity measurement with plain text display in the graphic display
- One-stop shop: no interface problems, smooth running with short times between definition of the task to joint commissioning and on-site system supervision with our global subsidiaries.

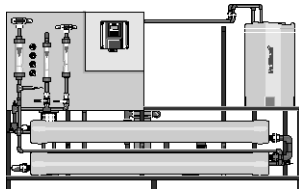

pk_7_064

Technical Details

- Turnkey systems constructed on a high-quality, double powder-coated steel or stainless steel frame
- Highly efficient low-pressure membranes with maximum output and system retention rates of over 99% integrated in epoxy-glass resin pressure pipes
- Pre-filter 5µm with manometer for determining differential pressure
- Pressure switch to protect the high-pressure pump
- Flow meter to display permeate, concentrate and concentrate return volume
- Semi-automatic cleaning system for chemical module cleaning for long module service lives
- 2 switching inputs for level control of the cleaning tank
- 2 switching inputs for level control of the permeate tank
- Pause switching input for external On/Off
- External fault switching input
- Temperature measuring input (PT 100)
- Active permeate valve output (filling of cleaning tank)
- Active output for flushing valve for initial permeate disposal (depending on conductivity), raw water, permeate and interval flushing (idle time management)
- Active output for controlling a metering pump (anti-scalant)
- Analogue output 0/4...20 mA conductance
- Optional industrial PLC with touch panel and process visualisation

Field of application

- Power plants: Provision of boiler feed water
- Electroplating / metal processing industry: Provision of rinsing water
- Beverage industry: Provision of rinsing water, product water and process and return dilution water
- Food industry: Provision of rinsing water and process water
- Chemical industry: Provision of rinsing water and process water
- Provision of rinsing water and process water for laboratory purposes and industrial rinsing machines
- Pure water for laboratory applications, hospital uses (autoclaves, high-speed steam generators)
- Feed water for cooling and air conditioning plants (air humidification and air scrubbers)
- Process water in printing plants, the pharmaceutical or cosmetics industry

8 Membrane Technology and Membrane Filtration

The product range Dulcosmose® TW was designed for the following values in feed water:

Salt content max.	1,000 mg/l*
pH range	3.0 ... 10.0
Silt density index max.	3
Free chlorine max.	0.1 mg/l
Total Fe, Mn max.	0.2 mg/l
Total hardness max.	0.1 °dH
Bacteria count max.	100 KBE/ml
Turbidity max.	0.5 NTU
COD max.	5 mg/l**

* Differing salinities affect the performance data accordingly

** As O₂

Systems with 8" membranes, system salt retention 90-97%

Plant	Permeate capacity at 15 °C water temperature l/h	Number of 8" membranes No.	Connected load kW	Dimensions
				H x W x D mm
PRO 0300TW	3,000	3	3.0	1,800 x 4,000 x 1,000
PRO 0400TW	4,000	4	3.0	1,800 x 3,000 x 1,000
PRO 0500TW	5,000	5	4.0	1,800 x 4,000 x 1,000
PRO 0600TW	6,000	6	4.0	1,800 x 4,000 x 1,000
PRO 0700TW	7,000	6	5.5	1,800 x 4,000 x 1,000
PRO 0800TW	8,000	7	5.5	1,800 x 4,000 x 1,000
PRO 0900TW	9,000	7	7.5	1,800 x 4,000 x 1,000
PRO 1000TW	10,000	8	11.0	1,800 x 3,000 x 1,000
PRO 1100TW	11,000	9	11.0	1,800 x 4,000 x 1,000
PRO 1200TW	12,000	10	11.0	1,800 x 4,000 x 1,000
PRO 1300TW	13,000	11	11.0	1,800 x 4,000 x 1,000
PRO 1400TW	14,000	12	11.0	1,800 x 4,000 x 1,000
PRO 1500TW	15,000	12	11.0	1,800 x 4,000 x 1,000
PRO 2000TW	20,000	18	11.0	1,800 x 7,000 x 1,200
PRO 2500TW	25,000	24	15.0	1,800 x 7,000 x 1,200*
PRO 3000TW	30,000	28	18.5	1,800 x 7,000 x 1,200*
PRO 4000TW	40,000	34	22.0	1,800 x 7,000 x 1,200*
PRO 5000TW	50,000	48	22.0	1,800 x 7,000 x 1,200*

* Separate cleaning tank

On request, these plants can also be supplied with different membrane types for further salt rejection, and with measuring and control equipment (conductivity, ORP, pH measurement) and metering equipment (in pre-treatment and post-treatment).

8 Membrane Technology and Membrane Filtration

8.7.3

Reverse Osmosis System Dulcosmose® BW

Brackish water is transformed into drinking water

Permeate output 2,000 – 50,000 l/h



Reverse osmosis system Dulcosmose® BW is the standard model for the modern desalination of brackish water. Equipped with the latest generation of "high rejection low-pressure" membranes, this system achieves maximum permeate output with moderate operating pressures, thereby lowering investment and operating costs.

A reverse osmosis system of type of BW has PVC pipework on the low-pressure side. The system has high-grade stainless steel (type DIN 1.4571) on the high-pressure side. Stainless steel pipes are welded under shielding gas and a forming gas atmosphere and subsequently passivated in a pickling bath. The integrated semi-automatic cleaning system with permeate and/or raw water flushing ensures exceptionally long membrane service lives, as scaling and fouling effects are minimised. The system is very adaptable to specific customer requirements. Pipework material, other types of membrane for enhanced salt retention, integration of measuring and control technology and metering technology to visualisation of the entire process with peripheral components via a PLC.

Your benefits

- Efficient operation with low pressure membranes with maximum output and salt retention rates of up to over 99 %
- Reduced maintenance and service costs as well as long membrane service lives, thanks to integrated cleaning concepts and flushing options
- Service-friendly construction of systems on a corrosion-resistant powder-coated steel or stainless steel frame
- Simple and safe to operate: Central control of the entire system by microprocessor controller or industrial PLC with touch panel and process visualisation.
- Application-optimised design taking into account economic aspects, such as the durability of the membranes, energy efficiency and process automation
- One-stop shop: no interface problems, smooth running with short times between definition of the task to joint commissioning and on-site system supervision with our global subsidiaries

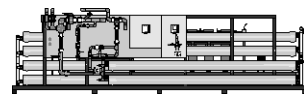

pk_7_065

Technical Details

- Turnkey systems constructed on a high-quality, double powder-coated steel or stainless steel frame.
- Highly efficient low-pressure membranes with maximum output and system retention rates of over 99% integrated in epoxy-glass resin pressure pipes
- Pre-filter 5µm with manometer for determining differential pressure
- Pressure switch to protect the high-pressure pump
- Flow meter to display permeate, concentrate and concentrate return volume
- Semi-automatic cleaning system for chemical module cleaning for long module service lives
- 2 switching inputs for level control of the cleaning tank
- 2 switching inputs for level control of the permeate tank
- Pause switching input for external On/Off
- External fault switching input
- Temperature measuring input (Pt 100)
- Active permeate valve output (filling of cleaning tank)
- Active output for flushing valve for initial permeate disposal (depending on conductivity), raw water, permeate and interval flushing (idle time management)
- Active output for controlling a metering pump (anti-scalant)
- Analogue output 0/4...20 mA conductance
- Optional industrial PLC with touch panel and process visualisation

Field of application

- Decentralised, public or private supply of potable water.

8 Membrane Technology and Membrane Filtration

The product range Dulcosmose® BW was designed for the following values in feed water:

Salt content max.	5,000 mg/l*
pH range	3.0 ... 10.0
Silt density index max.	3
Free chlorine max.	0.1 mg/l
Total Fe, Mn max.	0.2 mg/l
Total hardness max.	water must be chemically stabilised
Bacteria count max.	100 KBE/ml
Turbidity max.	0.5 NTU
COD max.	5 mg/l**

* Deviating salt contents have a corresponding influence on the performance data.

** As O₂

Systems with 8" membranes, system salt retention 95-99%

Plant	Permeate capacity at 25 °C water temperature	Number of 4" and 8" membranes	Connected load	Dimensions H x W x D
PRO 0200BW	2,000	9	4.0	1,800 x 3,500 x 750
PRO 0300BW	3,000	3	5.5	1,800 x 4,000 x 1,000
PRO 0400BW	4,000	4	5.5	1,800 x 3,000 x 1,000
PRO 0500BW	5,000	5	5.5	1,800 x 4,000 x 1,000
PRO 0600BW	6,000	6	7.5	1,800 x 4,000 x 1,000
PRO 0700BW	7,000	7	7.5	1,800 x 4,000 x 1,000
PRO 0800BW	8,000	8	15.0	1,800 x 4,000 x 1,000
PRO 0900BW	9,000	9	15.0	1,800 x 4,000 x 1,000
PRO 1000BW	10,000	10	15.0	1,800 x 4,000 x 1,000
PRO 1100BW	11,000	11	15.0	1,800 x 4,000 x 1,000
PRO 1200BW	12,000	12	15.0	1,800 x 5,000 x 1,000
PRO 1300BW	13,000	13	15.0	1,800 x 6,000 x 1,000
PRO 1400BW	14,000	14	15.0	1,800 x 5,000 x 1,000
PRO 1500BW	15,000	15	18.5	1,800 x 5,000 x 1,000
PRO 2000BW	20,000	21	18.5	1,800 x 6,000 x 1,200
PRO 2500BW	25,000	26	30.0	1,800 x 6,000 x 1,200*
PRO 3000BW	30,000	29	30.0	1,800 x 6,000 x 1,200*
PRO 4000BW	40,000	42	45.0	1,800 x 7,000 x 1,200*
PRO 5000BW	50,000	51	60.0	1,800 x 7,000 x 1,200*

* Separate cleaning tank

On request, these plants can also be supplied with different membrane types for other salt rejection, and with measuring and control equipment (conductivity, ORP, pH measurement) and metering equipment (in pre-treatment and post-treatment).

8 Membrane Technology and Membrane Filtration

8.7.4

Reverse Osmosis System Dulcosmose® SW

Salt water is transformed into drinking water.

Permeate output 780 – 29,000 l/h



The reverse osmosis system Dulcosmose® SW is the standard model for modern desalination of salt water. Equipped with the latest generation of "high rejection low-pressure" membranes, this system achieves maximum permeate output with moderate operating pressures, thereby lowering investment and operating costs.

A reverse osmosis system of type of SW has PVC pipework on the low-pressure side. The high-pressure side of the system has a potable water-compatible, highly corrosion-resistant inner seal due to the high NaCl content. The integrated semi-automatic cleaning system with permeate and/or raw water flushing ensures exceptionally long membrane service lives, as scaling and fouling effects are minimised. The system can be adapted with ease to specific customer requirements. Pipework material, other types of membrane for enhanced salt retention, integration of measuring and control technology and metering technology to visualisation of the entire process with peripheral components via a PLC. Everything can be selected at random. Optional for all systems: They can be fitted with a system for energy recovery from the concentrate flow. The latest generation of what are known as pressure controllers is used.

Your benefits

- Integrated energy recovery system based on state-of-the-art pressure controllers
- Efficient operation with low pressure membranes with outputs of up to 50% and high salt retention rates of up to over 99%
- Reduced maintenance and service costs as well as long membrane service lives, thanks to integrated cleaning concepts and flushing options
- Service-friendly construction of systems on a corrosion-resistant powder-coated steel or stainless steel frame
- Simple and safe to operate: Central control of the entire system by microprocessor controller or industrial PLC with touch panel and process visualisation
- Application-optimised design taking into account economic aspects, such as the durability of the membranes, energy efficiency and process automation
- One-stop shop: no interface problems, smooth running with short times between definition of the task to joint commissioning and on-site system supervision with our global subsidiaries

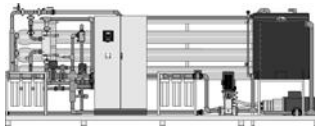

pk_7_074

Technical Details

- Turnkey systems constructed on a high-quality, double powder-coated steel or stainless steel frame
- Highly efficient low-pressure membranes with maximum output and system retention rates of over 99% integrated in epoxy-glass resin pressure pipes
- Pre-filter 5µm with manometer for determining differential pressure
- Pressure switch to protect the high-pressure pump
- Flow meter to display permeate and concentrate volume
- Semi-automatic cleaning system for chemical module cleaning for long module service lives
- Central PLC of the entire system and peripheral components, adapted to customer requirements

Field of application

- Decentralised, public or private supply of potable water.

The product range Dulcosmose® SW was designed for the following values in feed water:

Salt content max.	40,000 mg/l*
pH range	3.0 ... 10.0
Silt density index max.	3
Free chlorine max.	0.1 mg/l
Total Fe, Mn max.	0.2 mg/l
Total hardness max.	water must be chemically stabilised
Bacteria count max.	100 KBE/ml
Turbidity max.	0.5 NTU
COD max.	5 mg/l**

* Differing salinities affect the performance data accordingly

** As O₂

8 Membrane Technology and Membrane Filtration

Plants with 4" and 8" membranes, salt rejection of the plants 99%

Plant	Permeate capacity at 25 °C water temperature l/h	Number of 4" and 8" membranes No.	Connected load without energy recovery kW	Connected load with energy recovery kW	Dimensions H x W x D mm
PRO 0078SW	780	6	5.5		1,800 x 3,500 x 1,000
PRO 0185SW	1,850	3	11.0		1,800 x 4,000 x 1,000
PRO 0240SW	2,400	4	15.0		1,800 x 4,000 x 1,000
PRO 0300SW	3,000	5	18.5	11.2*	1,800 x 4,000 x 1,000
PRO 0360SW	3,600	6	18.5	14.7*	1,800 x 4,000 x 1,000
PRO 0490SW	4,900	8	30.0	20.5*	1,800 x 5,000 x 1,200
PRO 0610SW	6,100	10	37.0	20.5*	1,800 x 6,000 x 1,200
PRO 0730SW	7,300	12	41.0	24.0*	1,800 x 5,000 x 1,400
PRO 0920SW	9,200	15	75.0	27.5*	1,800 x 6,000 x 1,500
PRO 0980SW	9,800	16	75.0	35.5*	1,800 x 5,000 x 1,500
PRO 1230SW	12,300	20	75.0	35.5*	1,800 x 6,000 x 1,500**
PRO 1470SW	14,700	24	90.0	41.0*	1,800 x 7,000 x 1,500**
PRO 1840SW	18,400	30	110.0	56.0*	1,800 x 7,000 x 1,500**
PRO 2210SW	22,100	36	132.0	66.0*	1,800 x 7,000 x 1,500**
PRO 2580SW	25,800	42	150.0	66.0*	1,800 x 7,000 x 1,500**
PRO 2900SW	29,000	48	180.0	90.0*	1,800 x 7,000 x 1,500**

* Energy recovery by pressure exchanger technology

** Separate cleaning tank

On request, these plants can also be supplied with different membrane types for other salt rejection, and with measuring and control equipment (conductivity, ORP, pH measurement) and metering equipment (in pre-treatment and post-treatment).

8 Membrane Technology and Membrane Filtration

Product catalogue 2018

Order your personal copy.
How you want it, when you want it.

Groundbreaking diversity: ProMinent 2018.

Our product catalogue is available in four individual volumes. We are offering you the following options so that you can request your catalogue of choice.



Metering pumps, components
and metering systems



Motor-driven and process metering
pumps for all capacity ranges



Measuring, control and
sensor technology



Water treatment and
water disinfection

You can find the ProMinent app for iPads in the iTunes App Store.
www.prominent.com/app



You can find our individual catalogue volumes for download or online browsing at
www.prominent.com/en/product-catalogue
Or request your own printed copy directly from us at
www.prominent.com/en/catalogue-request

Do you need an overview of our entire product range?
Then we would recommend our product overview.
www.prominent.com/en/productoverview

– официальный представитель и сервисный партнер

www.promhimtech.ru
zakaz@promhimtech.ru
тел. 8 800 250 01 54